

CROSS SECTIONS
Scale 1 inch = 5 feet

CUT

FILL

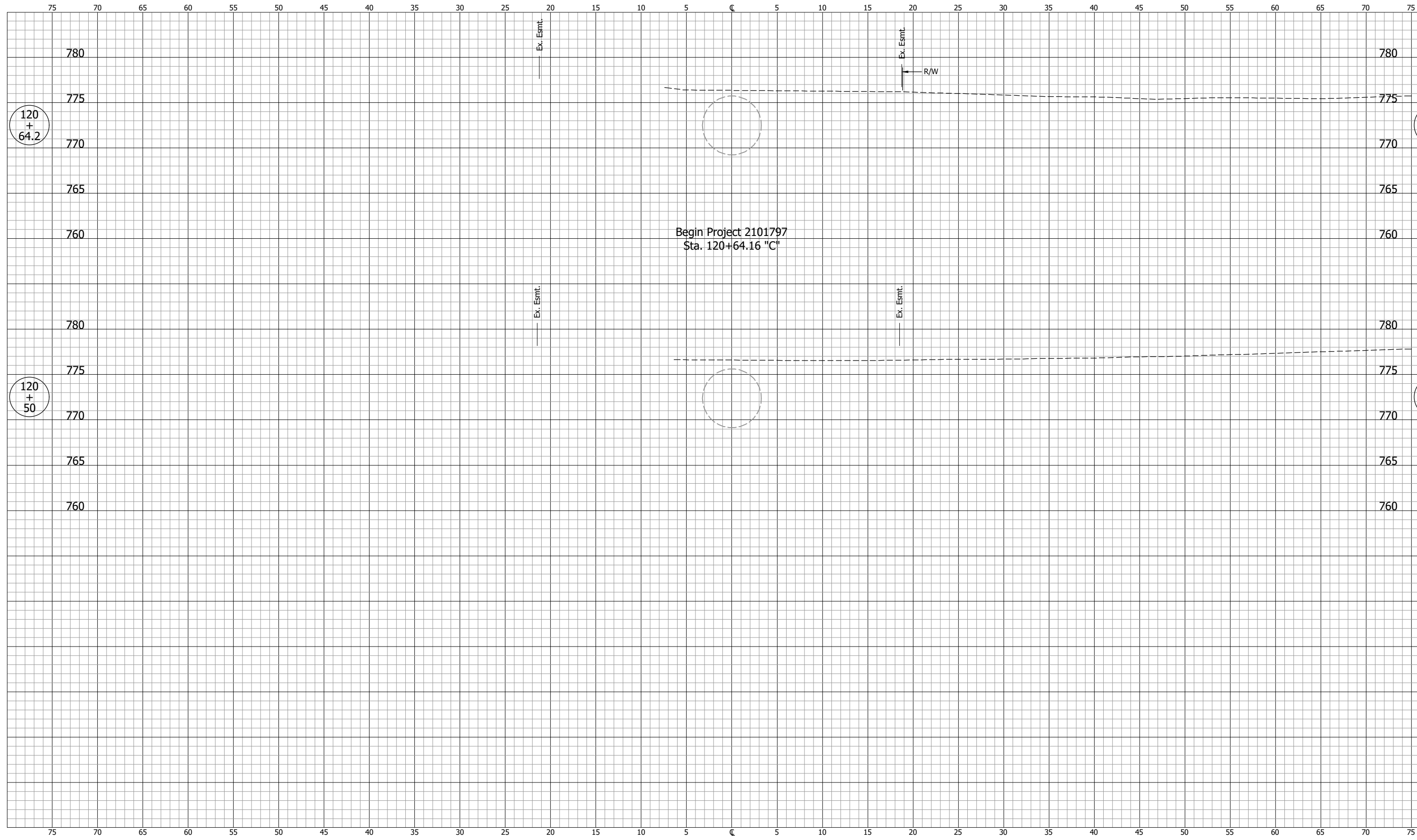

PJV - 2/9/2024 11:48 AM - U:\2021\2021124 indot us35\Cad\C3D\Design Files\212443D_CO1.dwg (XS_223_C)

NOT FOR CONSTRUCTION		INDIANA DEPARTMENT OF TRANSPORTATION		SCALE	BRIDGE FILE
				1" = 5'	
DESIGNED: DGA DRAWN: GDH CHECKED: DGD CHECKED: DGA		CROSS SECTIONS LINE "C"		DESIGNATION	
				2001885 & 2101797	
				SURVEY BOOK	SHEETS
				R-43382	212 of 357
				CONTRACT	PROJECT
					2001885

PJV - 2/9/2024 11:48 AM - U:\2021\202124 indot us35\Cad\C3D\Design Files\212443D_CO1.dwg (XS_224_C)

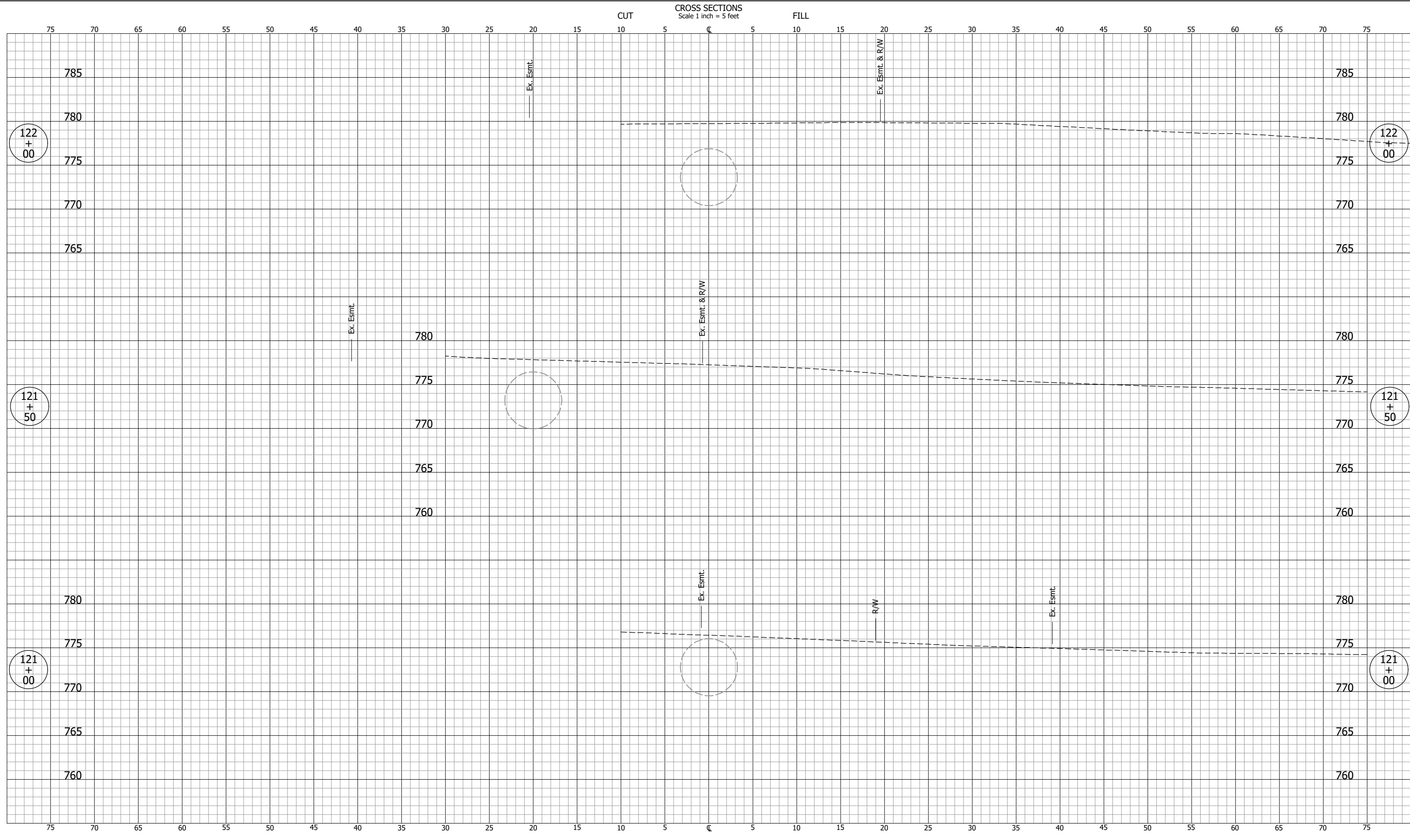

NOT FOR CONSTRUCTION		INDIANA DEPARTMENT OF TRANSPORTATION		SCALE 1" = 5'	BRIDGE FILE
		CROSS SECTIONS LINE "C"		DESIGNATION 2001885 & 2101797	
SURVEY BOOK	SHEETS				
CONTRACT R-43382	213			of	357
DESIGNED: DGA	DRAWN: GDH			PROJECT 2001885	
CHECKED: DGD	CHECKED: DGA				

PJV - 2/9/2024 11:48 AM - U:\2021\2021124 indot us35\Cad\C3D\Design Files\212443D_CO1.dwg (XS_225_C)

CROSS SECTIONS
Scale 1 inch = 5 feet

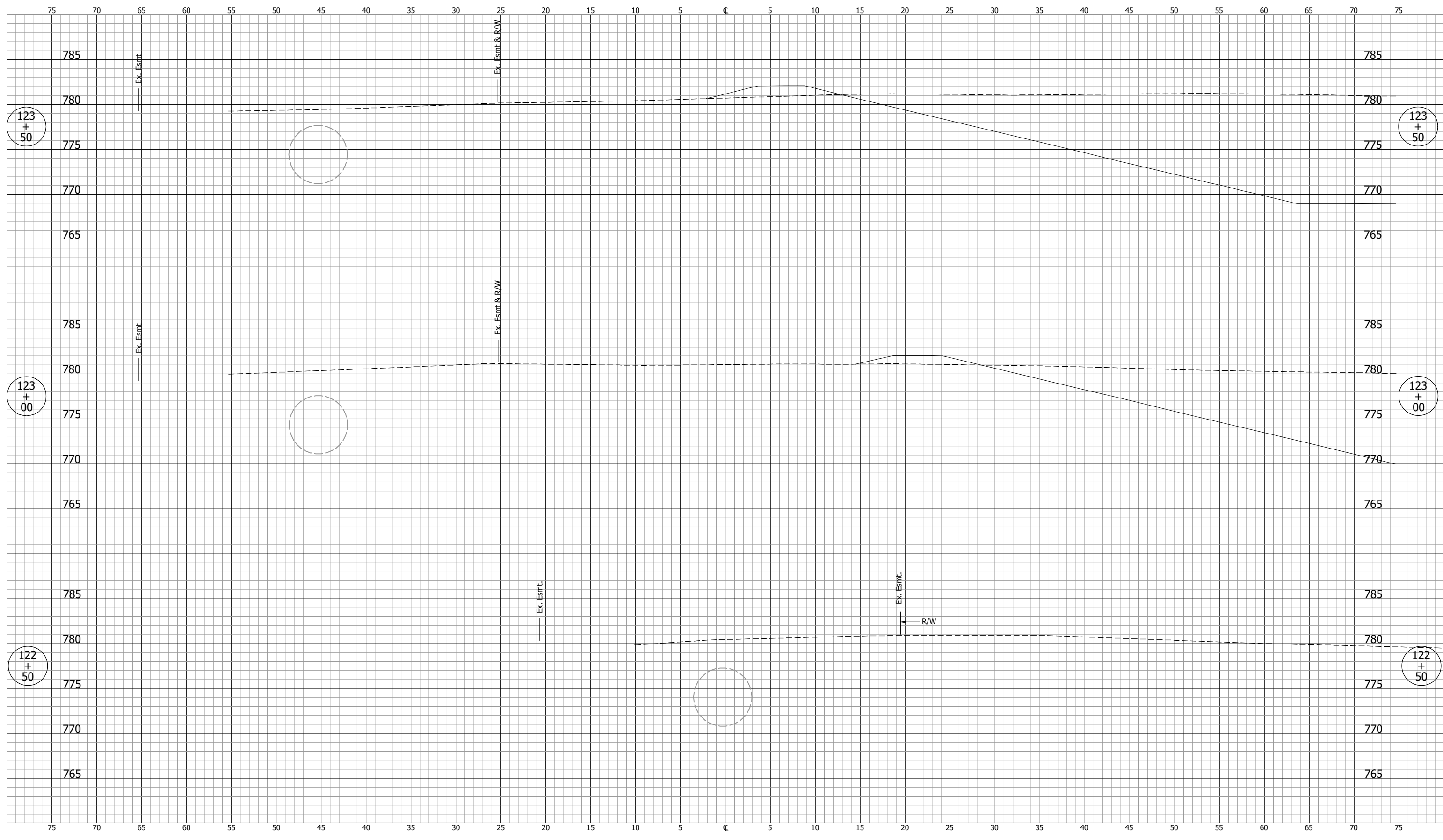

NOT FOR CONSTRUCTION		INDIANA DEPARTMENT OF TRANSPORTATION		SCALE 1" = 5'	BRIDGE FILE
		CROSS SECTIONS LINE "C"		DESIGNATION 2001885 & 2101797	
DESIGNED: DGA	DRAWN: GDH			SURVEY BOOK	SHEETS 214 of 357
CHECKED: DGD	CHECKED: DGA			CONTRACT R-43382	PROJECT 2001885

PJV - 2/9/2024 11:48 AM - U:\2021\202124 indot us35\Cad\C3D\Design Files\212443D_CO1.dwg (XS_226_C)

CROSS SECTIONS
Scale 1 inch = 5 feet

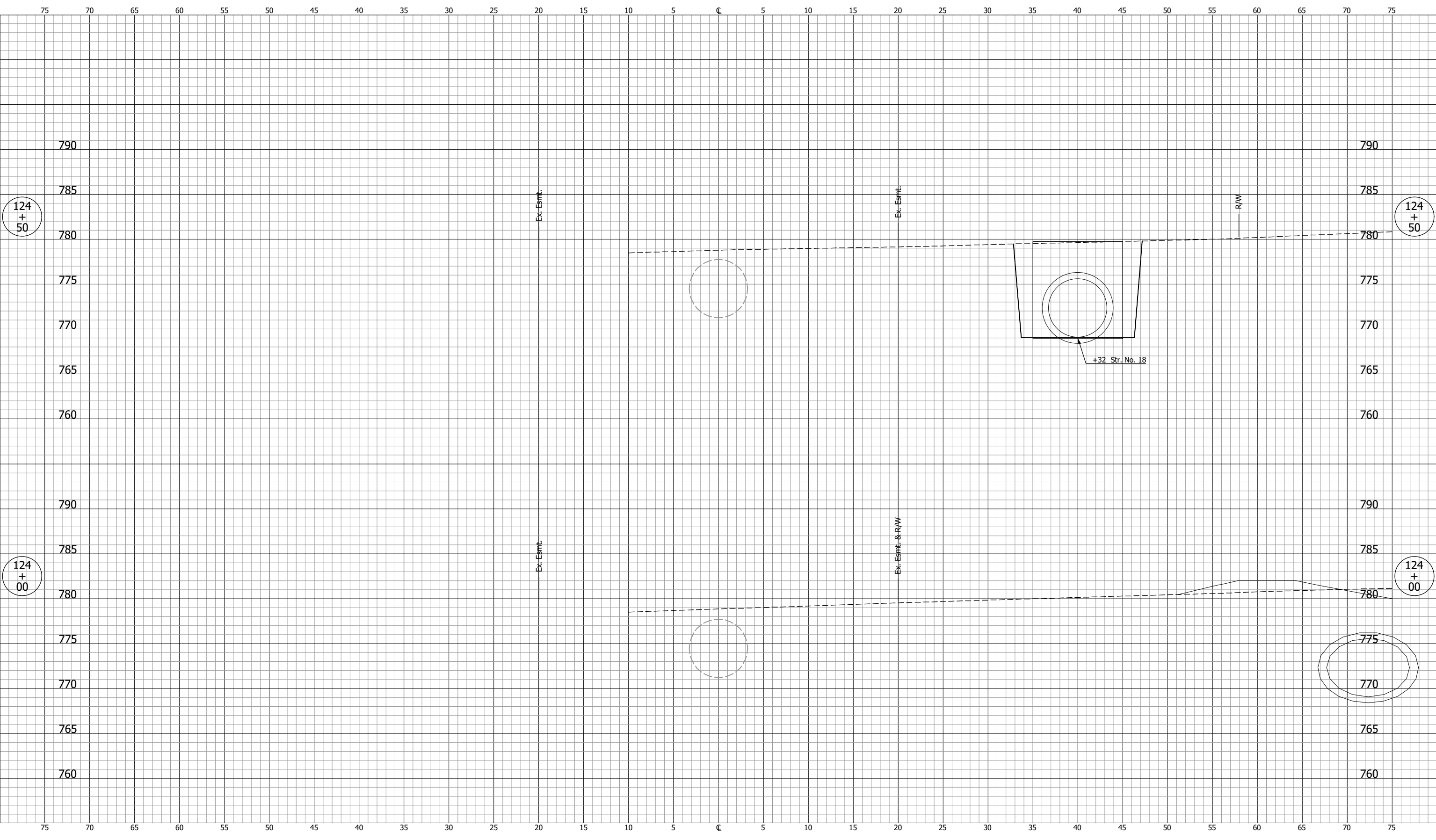

NOT FOR CONSTRUCTION

DESIGNED: DGA	DRAWN: GDH
CHECKED: DGD	CHECKED: DGA

INDIANA
DEPARTMENT OF TRANSPORTATION

**CROSS SECTIONS
LINE "C"**

SCALE 1" = 5'	BRIDGE FILE
	DESIGNATION 2001885 & 2101797
SURVEY BOOK	SHEETS 215 of 357
CONTRACT R-43382	PROJECT 2001885

PJV - 2/9/2024 11:49 AM - U:\2021\202124 indot us35\Cad\C3D\Design Files\212443D_CO1.dwg (XS_227_C)

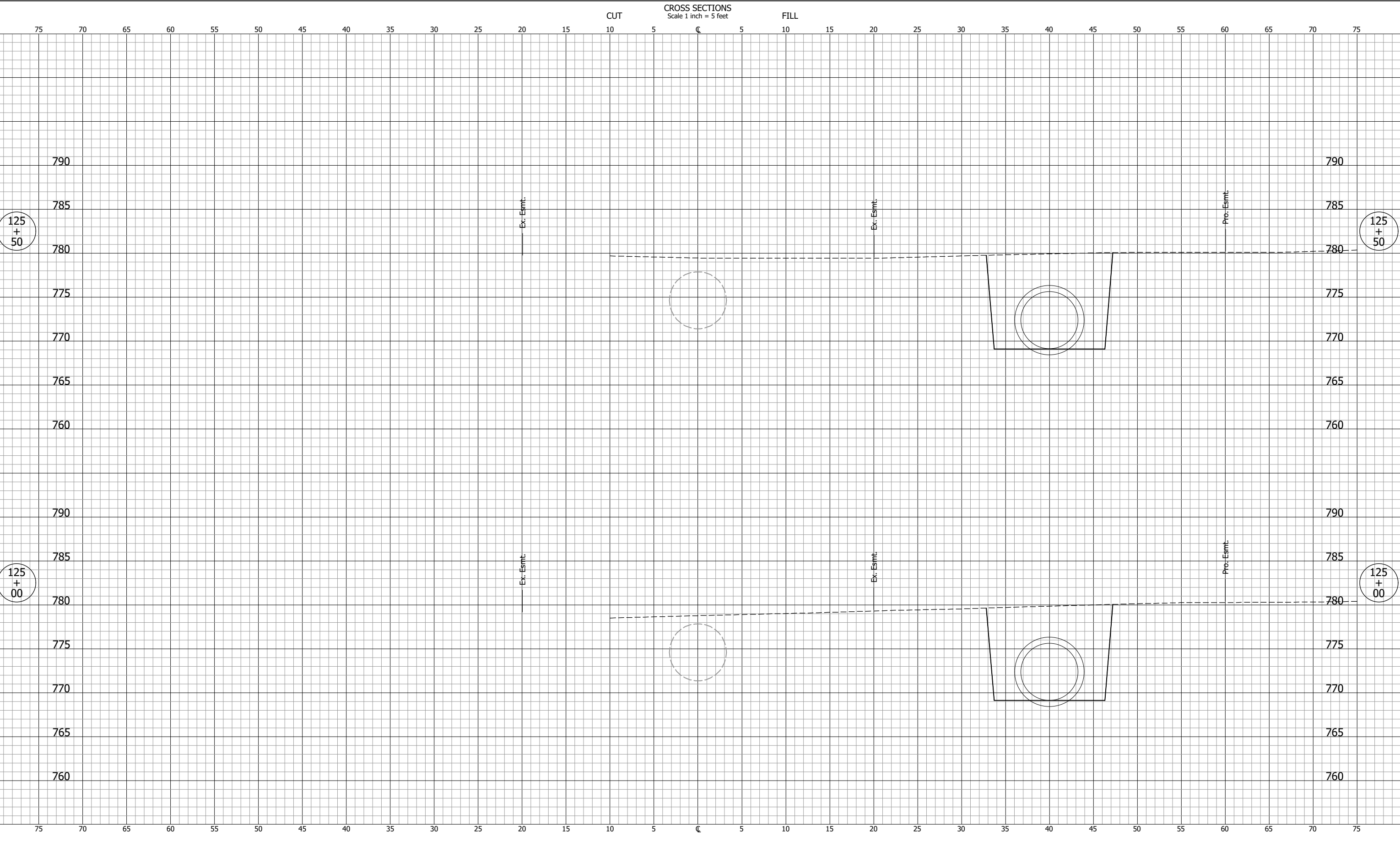

NOT FOR CONSTRUCTION

DESIGNED: DGA	DRAWN: GDH
CHECKED: DGD	CHECKED: DGA

**INDIANA
DEPARTMENT OF TRANSPORTATION**

**CROSS SECTIONS
LINE "C"**

SCALE 1" = 5'	BRIDGE FILE
SURVEY BOOK	DESIGNATION 2001885 & 2101797
CONTRACT R-43382	SHEETS 216 of 357 PROJECT 2001885

PJV - 2/9/2024 11:49 AM - U:\2021\202124 indot us35\Cad\C3D\Design Files\212443D_CO1.dwg (XS_228_C)

CROSS SECTIONS
Scale 1 inch = 5 feet

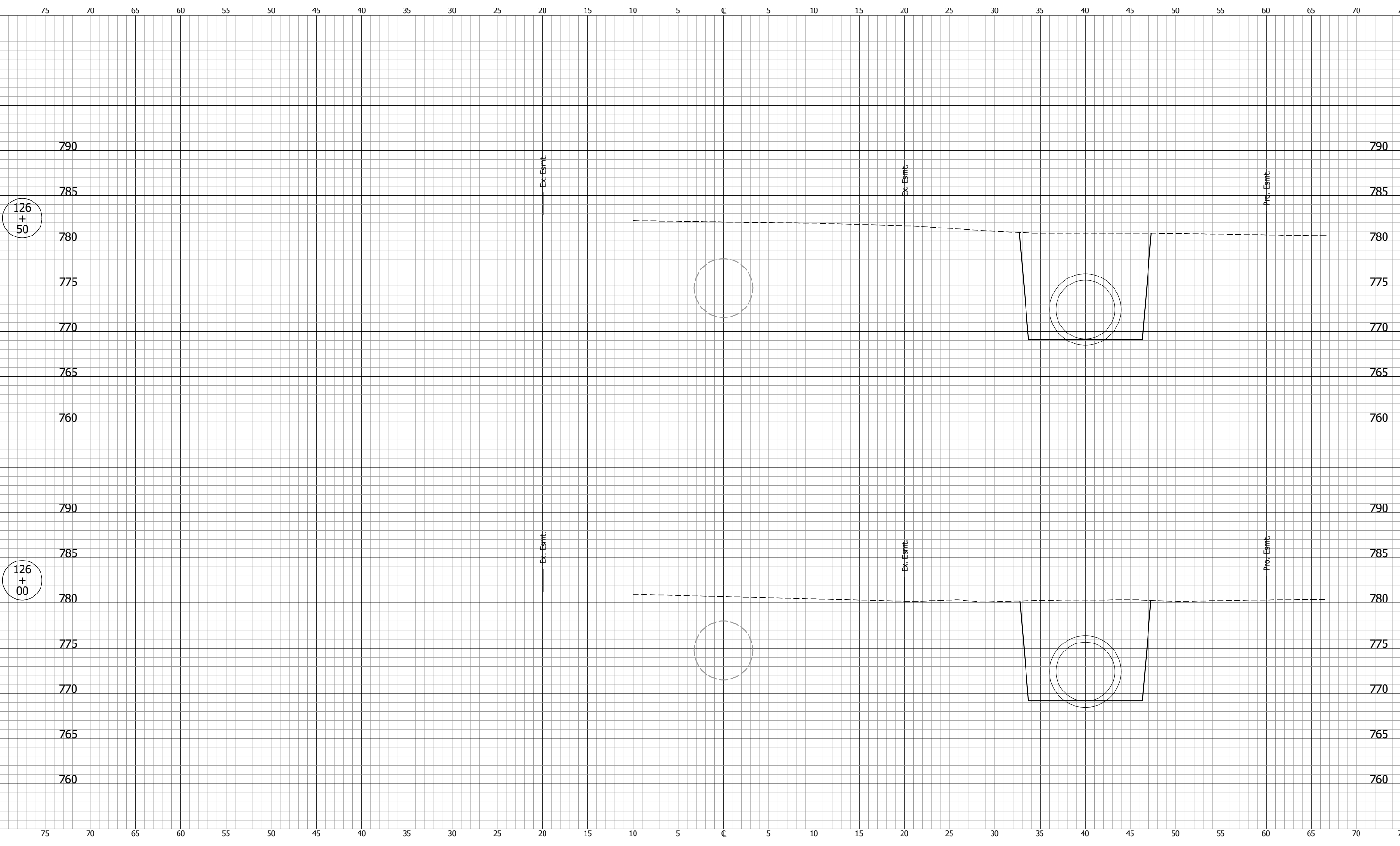

NOT FOR CONSTRUCTION

DESIGNED: DGA	DRAWN: GDH
CHECKED: DGD	CHECKED: DGA

INDIANA
DEPARTMENT OF TRANSPORTATION

**CROSS SECTIONS
LINE "C"**

SCALE 1" = 5'	BRIDGE FILE
	DESIGNATION 2001885 & 2101797
SURVEY BOOK	SHEETS 217 of 357
CONTRACT R-43382	PROJECT 2001885

PJV - 2/9/2024 11:49 AM - U:\2021\202124 indot us35\Cad\C3D\Design Files\2124430_CO1.dwg (XS_229_C)

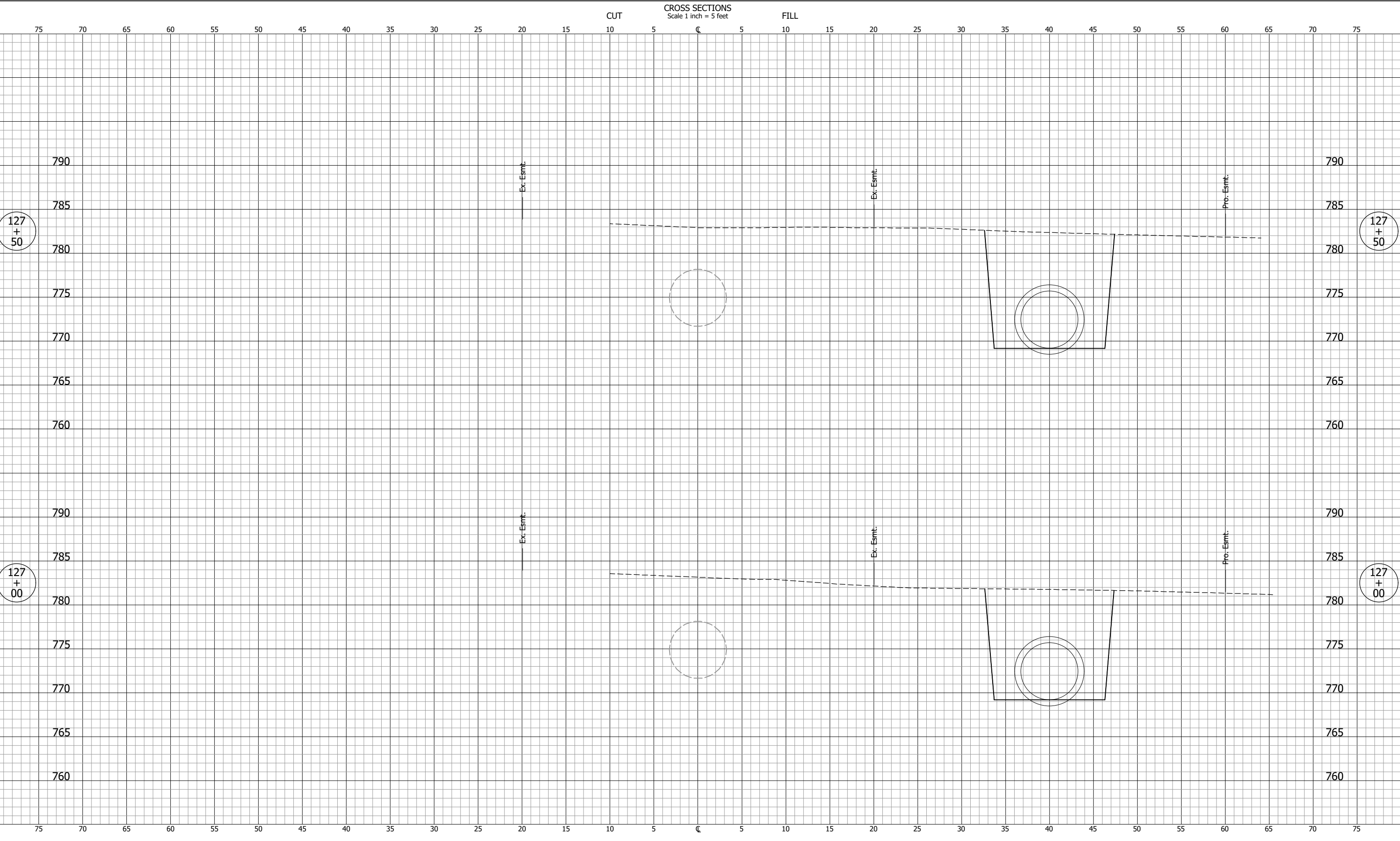

NOT FOR CONSTRUCTION

DESIGNED: DGA	DRAWN: GDH
CHECKED: DGD	CHECKED: DGA

INDIANA
DEPARTMENT OF TRANSPORTATION

**CROSS SECTIONS
LINE "C"**

SCALE 1" = 5'	BRIDGE FILE
SURVEY BOOK	DESIGNATION 2001885 & 2101797
CONTRACT R-43382	SHEETS 218 of 357
	PROJECT 2001885

CROSS SECTIONS
Scale 1 inch = 5 feet

CUT

FILL

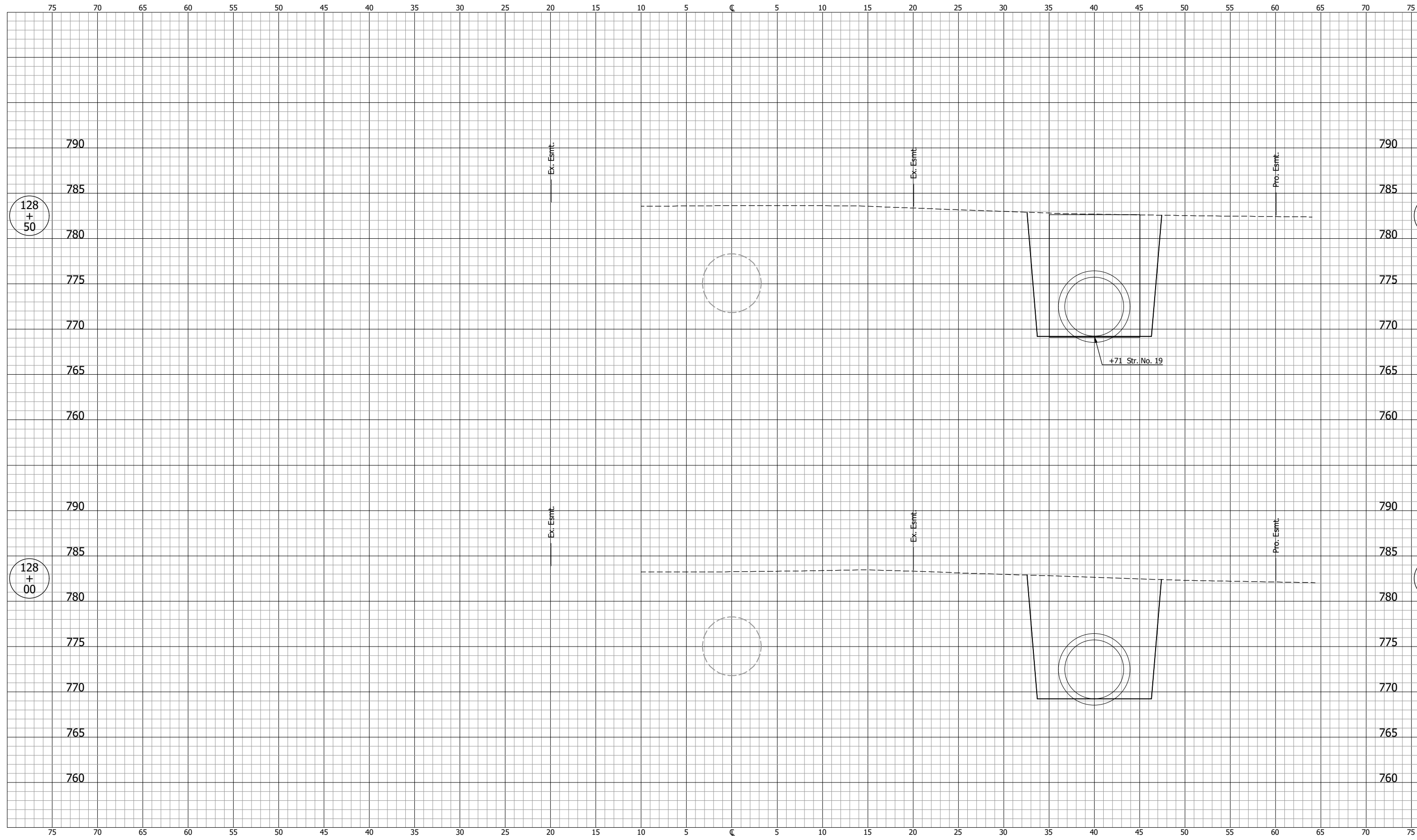

128
+
50

128
+
50

128
+
00

128
+
00

NOT FOR CONSTRUCTION

INDIANA
DEPARTMENT OF TRANSPORTATION

DESIGNED: DGA DRAWN: GDH
CHECKED: DGD CHECKED: DGA

CROSS SECTIONS
LINE "C"

SCALE 1" = 5'	BRIDGE FILE
	DESIGNATION 2001885 & 2101797
SURVEY BOOK	SHEETS 219 of 357
CONTRACT R-43382	PROJECT 2001885

PJV - 2/9/2024 11:49 AM - U:\2021\202124 indot us35\Cad\C3D\Design Files\212443D_CO1.dwg (XS_231_C)

CROSS SECTIONS
Scale 1 inch = 5 feet

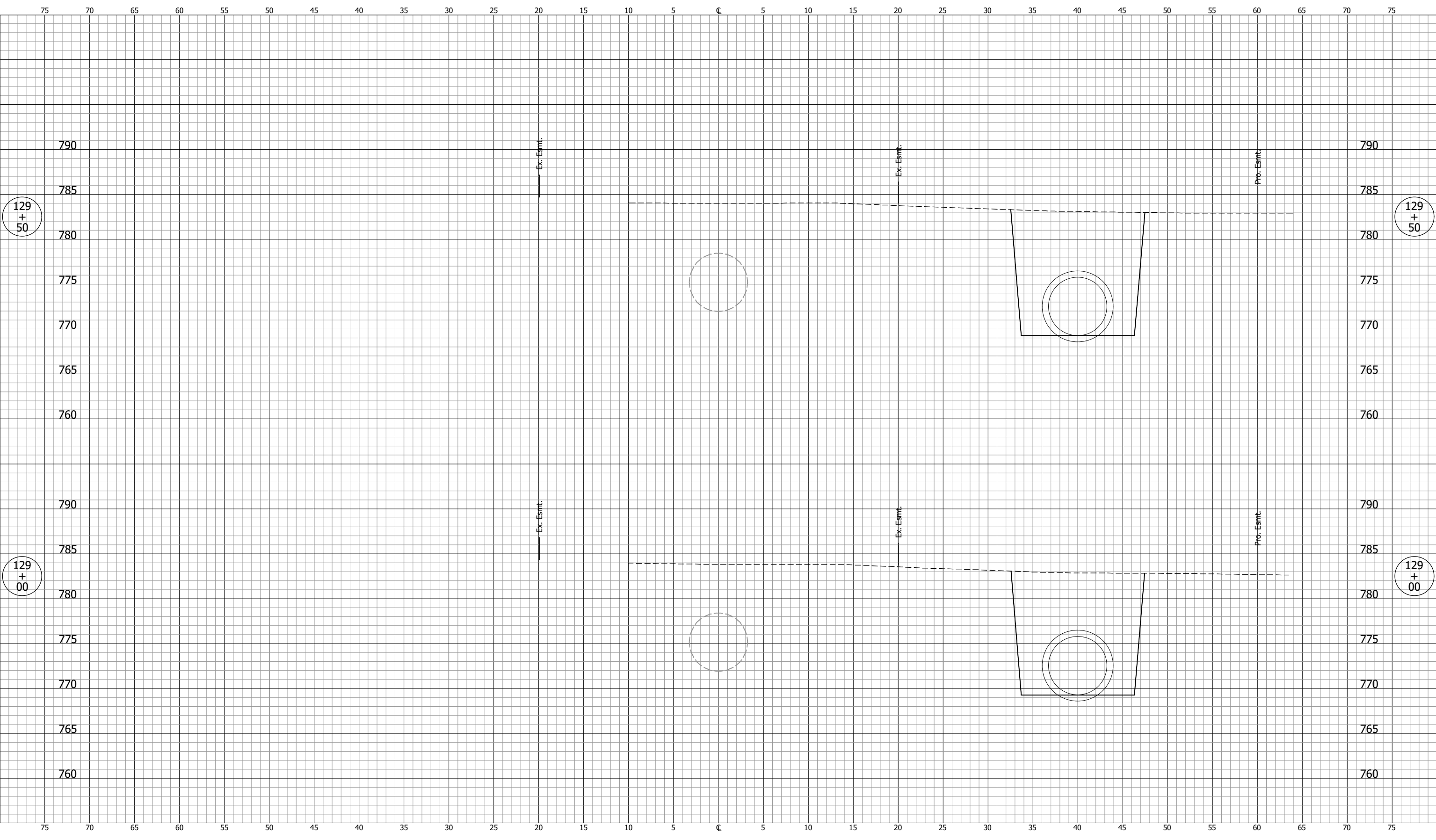

NOT FOR CONSTRUCTION

DESIGNED: DGA	DRAWN: GDH
CHECKED: DGD	CHECKED: DGA

INDIANA
DEPARTMENT OF TRANSPORTATION

**CROSS SECTIONS
LINE "C"**

SCALE 1" = 5'	BRIDGE FILE
	DESIGNATION 2001885 & 2101797
SURVEY BOOK	SHEETS 220 of 357
CONTRACT R-43382	PROJECT 2001885

PJV - 2/9/2024 11:49 AM - U:\2021\202124 indot us35\Cad\C3D\Design Files\212443D_CO1.dwg (XS_232_C)

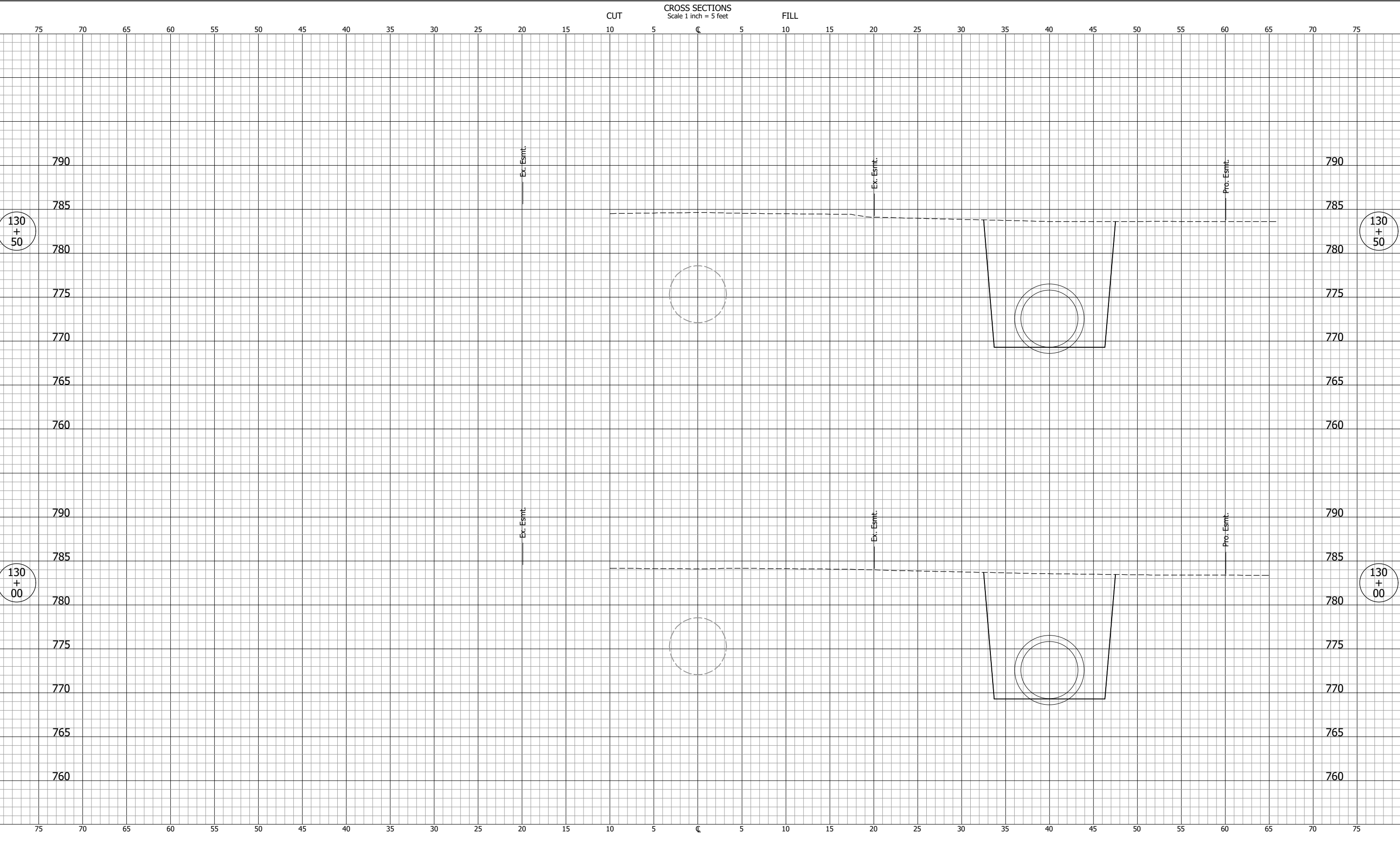

NOT FOR CONSTRUCTION

DESIGNED: DGA	DRAWN: GDH
CHECKED: DGD	CHECKED: DGA

INDIANA
DEPARTMENT OF TRANSPORTATION

**CROSS SECTIONS
LINE "C"**

SCALE 1" = 5'	BRIDGE FILE
SURVEY BOOK	DESIGNATION 2001885 & 2101797
CONTRACT R-43382	SHEETS 221 of 357 PROJECT 2001885

PJV - 2/9/2024 11:49 AM - U:\2021\202124 indot us35\Cad\C3D\Design Files\212443D_CO1.dwg (XS_234_C)

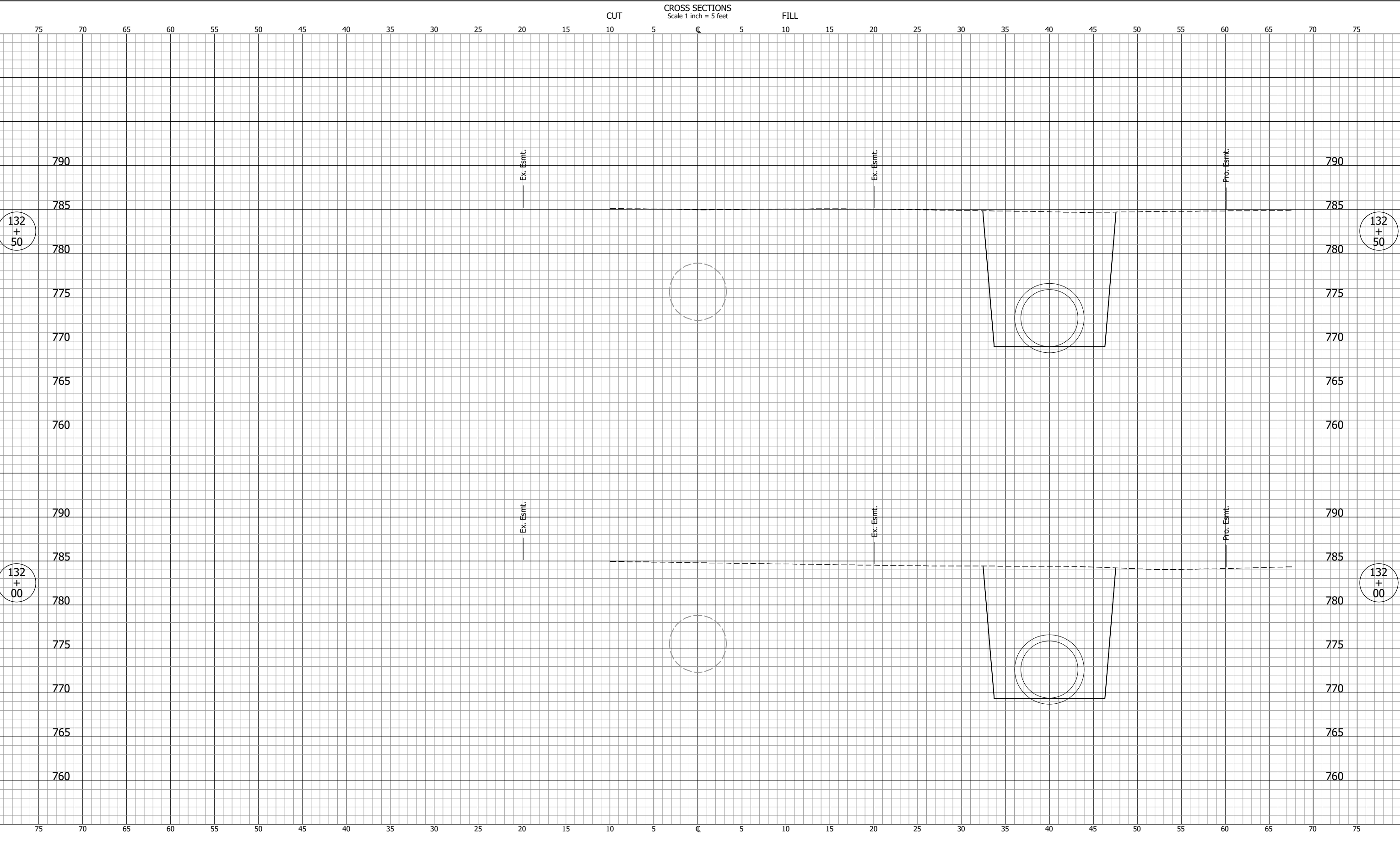

NOT FOR CONSTRUCTION

DESIGNED: DGA	DRAWN: GDH
CHECKED: DGD	CHECKED: DGA

INDIANA
DEPARTMENT OF TRANSPORTATION

**CROSS SECTIONS
LINE "C"**

SCALE 1" = 5'	BRIDGE FILE
	DESIGNATION 2001885 & 2101797
SURVEY BOOK	SHEETS 223 of 357
CONTRACT R-43382	PROJECT 2001885

PJV - 2/9/2024 11:49 AM - U:\2021\202124 indot us35\Cad\C3D\Design Files\2124430_CO1.dwg (XS_235_C)

CROSS SECTIONS
Scale 1 inch = 5 feet

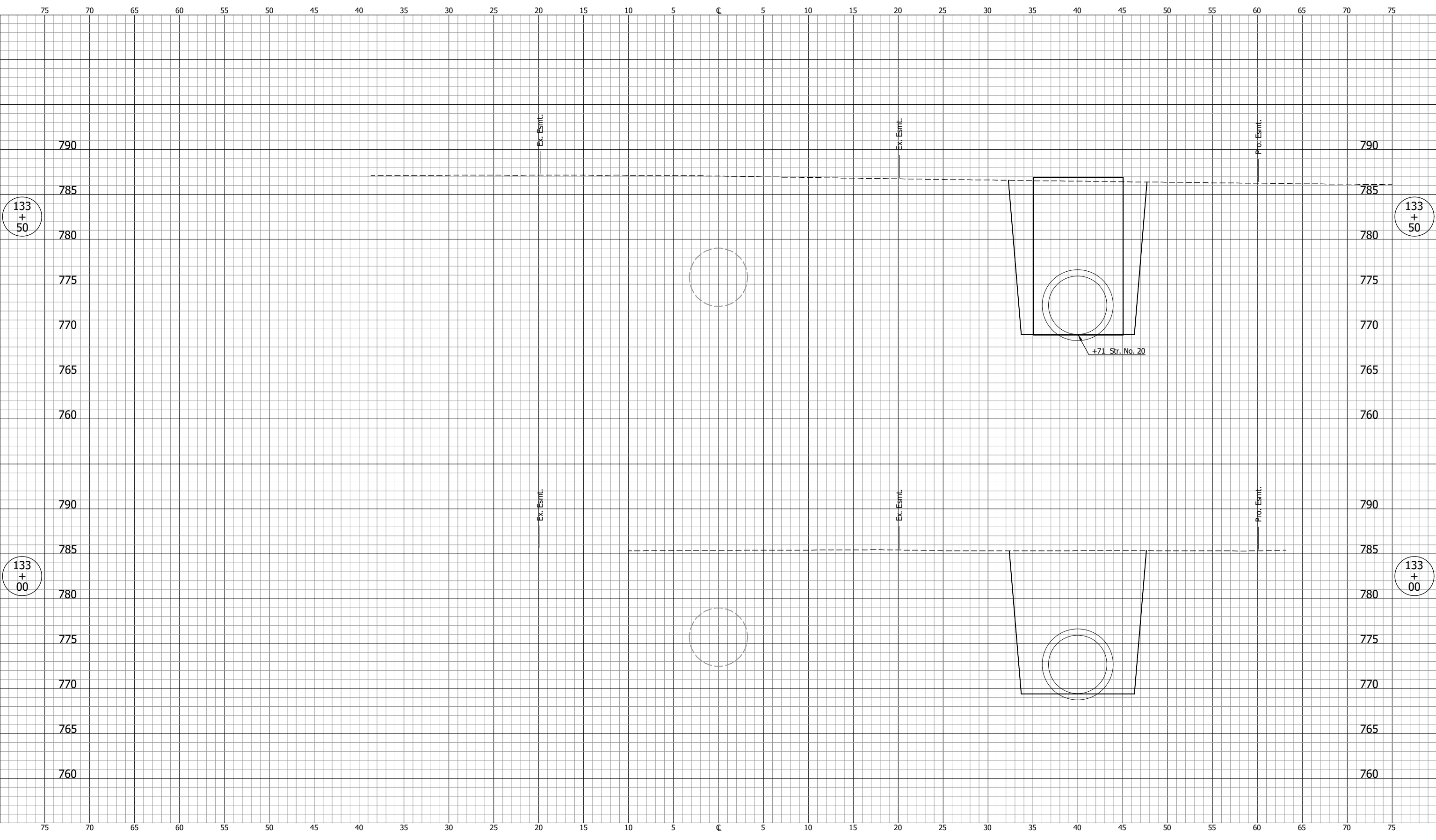

NOT FOR CONSTRUCTION		INDIANA DEPARTMENT OF TRANSPORTATION		SCALE 1" = 5'	BRIDGE FILE
		CROSS SECTIONS LINE "C"		DESIGNATION 2001885 & 2101797	
DESIGNED: DGA	DRAWN: GDH			SURVEY BOOK	SHEETS 224 of 357
CHECKED: DGD	CHECKED: DGA			CONTRACT R-43382	PROJECT 2001885

PJV - 2/9/2024 11:49 AM - U:\2021\202124 indot us35\Cad\C3D\Design Files\212443D_CO1.dwg (XS_236_C)

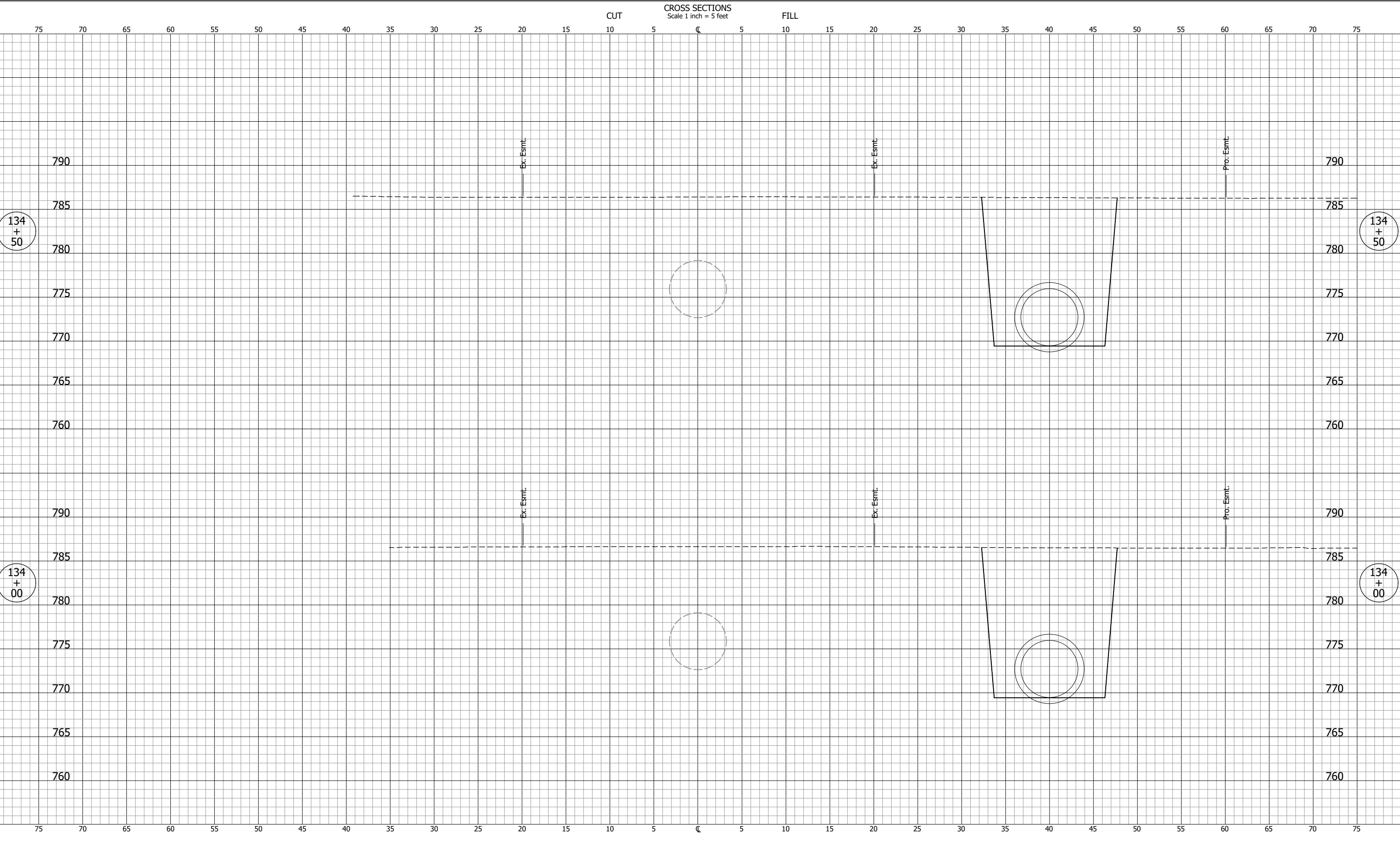

NOT FOR CONSTRUCTION

DESIGNED: DGA DRAWN: GDH
 CHECKED: DGD CHECKED: DGA

INDIANA
 DEPARTMENT OF TRANSPORTATION

**CROSS SECTIONS
 LINE "C"**

SCALE 1" = 5'	BRIDGE FILE
	DESIGNATION 2001885 & 2101797
SURVEY BOOK	SHEETS 225 of 357
CONTRACT R-43382	PROJECT 2001885

PJV - 2/9/2024 11:49 AM - U:\2021\202124 indot us35\Cad\C3D\Design Files\212443D_CO1.dwg (XS_237_C)

CROSS SECTIONS
Scale 1 inch = 5 feet

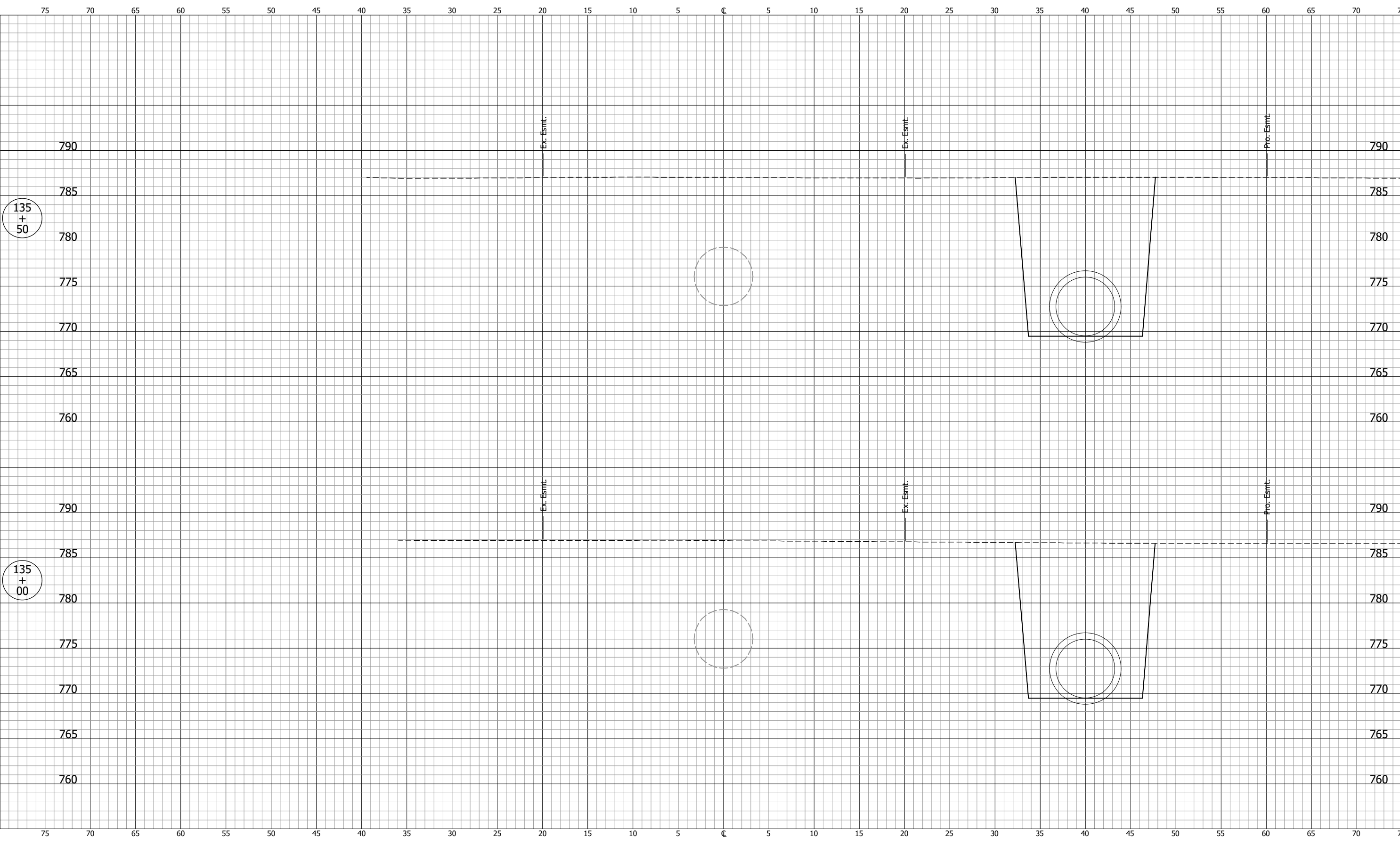

NOT FOR CONSTRUCTION

DESIGNED: DGA DRAWN: GDH
CHECKED: DGD CHECKED: DGA

INDIANA
DEPARTMENT OF TRANSPORTATION

**CROSS SECTIONS
LINE "C"**

SCALE 1" = 5'	BRIDGE FILE
	DESIGNATION 2001885 & 2101797
SURVEY BOOK	SHEETS 226 of 357
CONTRACT R-43382	PROJECT 2001885

PJV - 2/9/2024 11:49 AM - U:\2021\202124 indot us35\Cad\C3D\Design Files\212443D_CO1.dwg (XS_238_C)

CROSS SECTIONS
Scale 1 inch = 5 feet

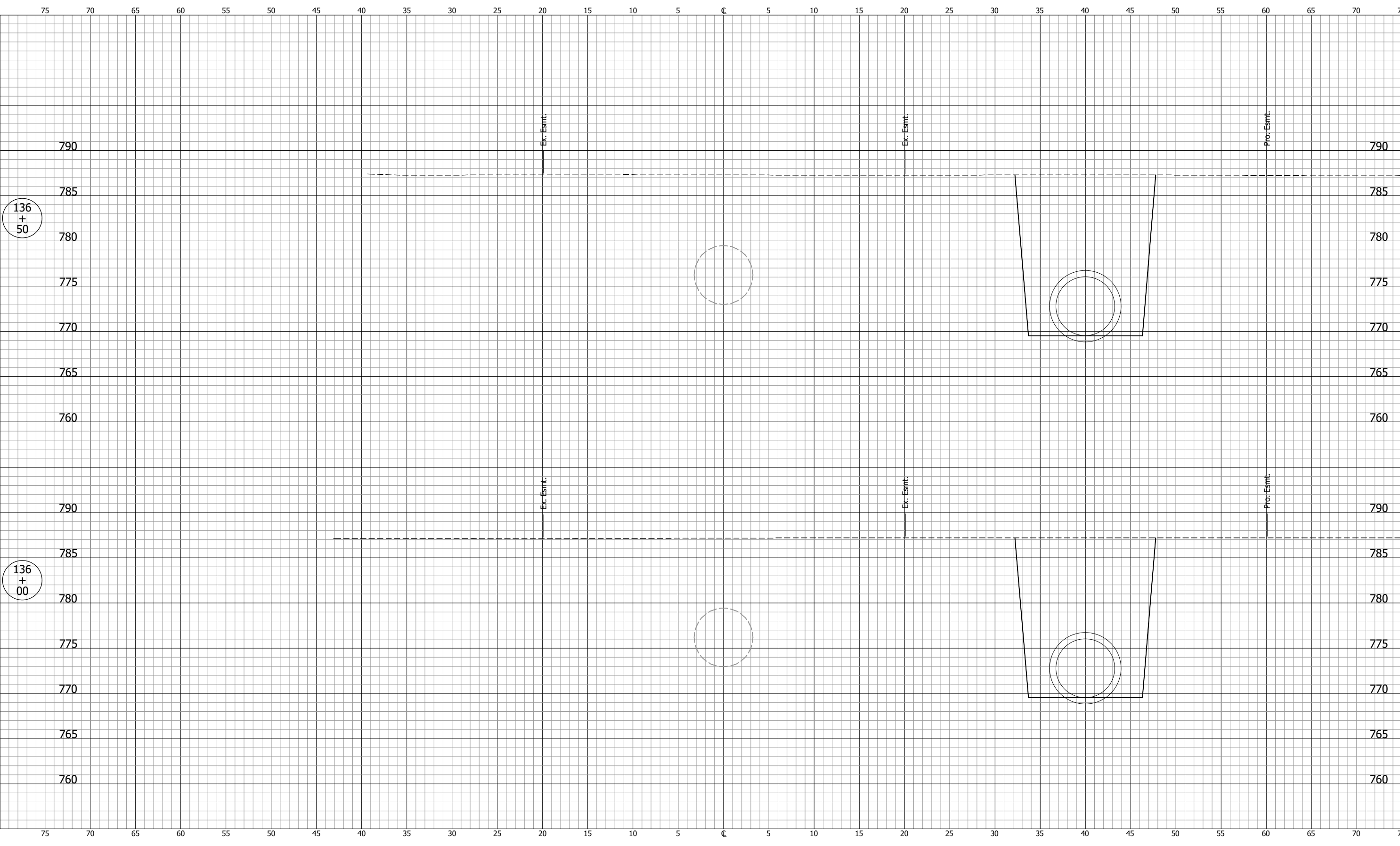

NOT FOR CONSTRUCTION		INDIANA DEPARTMENT OF TRANSPORTATION		SCALE 1" = 5'	BRIDGE FILE
		CROSS SECTIONS LINE "C"		DESIGNATION 2001885 & 2101797	
SURVEY BOOK	SHEETS				
CONTRACT R-43382	227 of 357 PROJECT 2001885				
DESIGNED: DGA	DRAWN: GDH				
CHECKED: DGD	CHECKED: DGA				

PJV - 2/9/2024 11:50 AM - U:\2021\202124 indot us35\Cad\C3D\Design Files\212443D_CO1.dwg (XS_239_C)

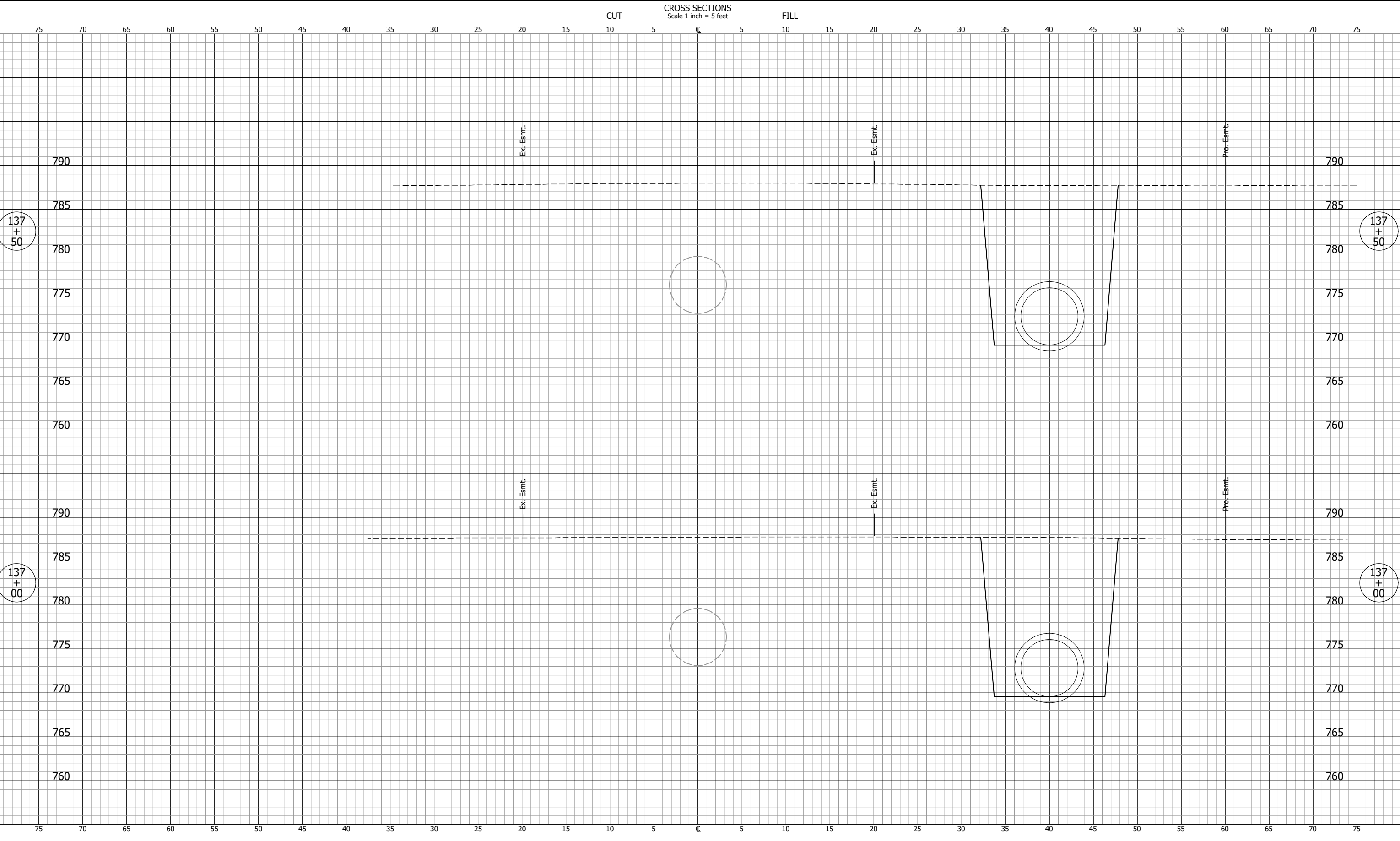

NOT FOR CONSTRUCTION

DESIGNED: DGA DRAWN: GDH
 CHECKED: DGD CHECKED: DGA

INDIANA
 DEPARTMENT OF TRANSPORTATION

**CROSS SECTIONS
 LINE "C"**

SCALE 1" = 5'	BRIDGE FILE
	DESIGNATION 2001885 & 2101797
SURVEY BOOK	SHEETS 228 of 357
CONTRACT R-43382	PROJECT 2001885

PJV - 2/9/2024 11:50 AM - U:\2021\202124 indot us35\Cad\C3D\Design Files\212443D_CO1.dwg (XS_240_C)

CROSS SECTIONS
Scale 1 inch = 5 feet

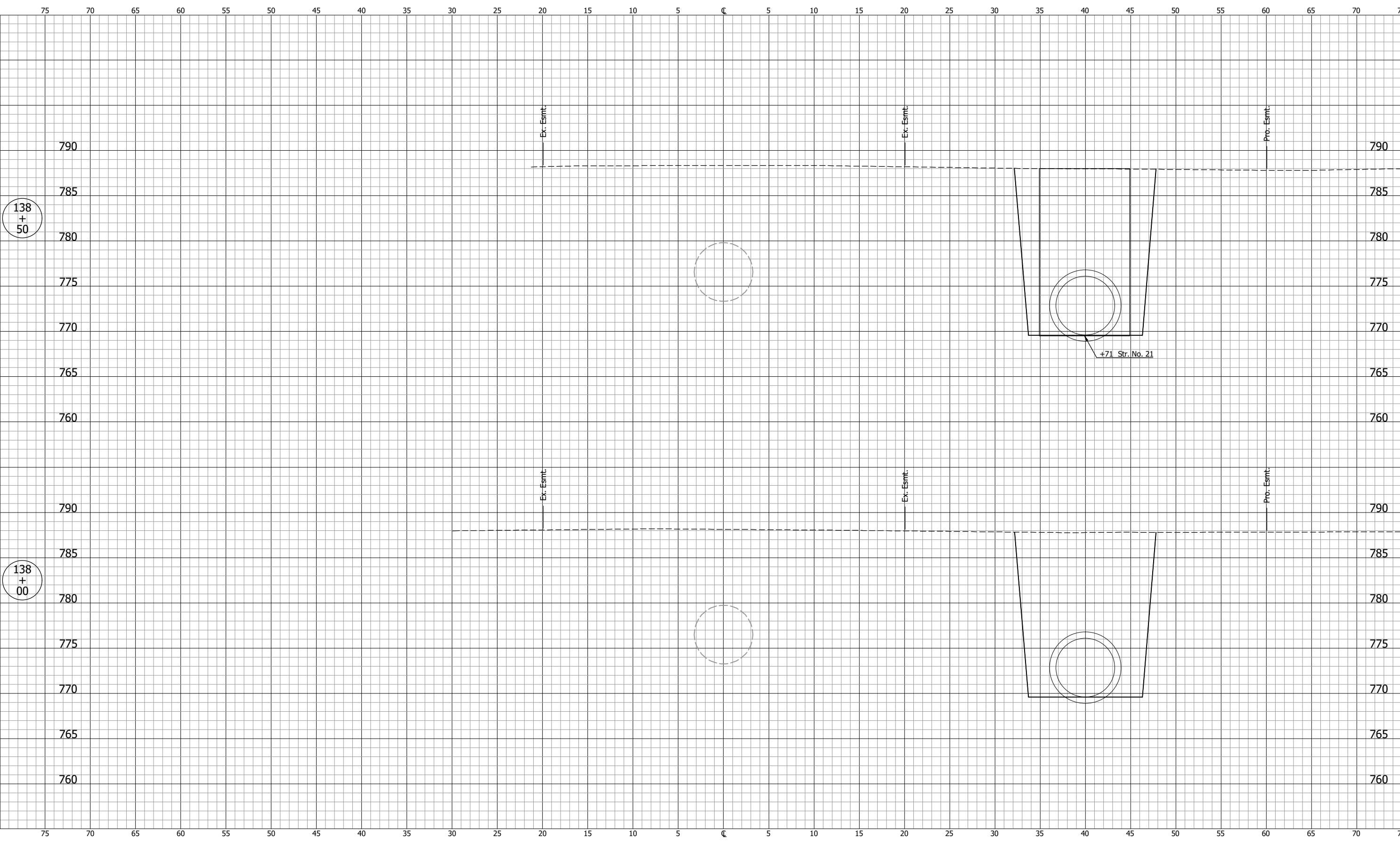

NOT FOR CONSTRUCTION

DESIGNED: DGA	DRAWN: GDH
CHECKED: DGD	CHECKED: DGA

INDIANA
DEPARTMENT OF TRANSPORTATION

**CROSS SECTIONS
LINE "C"**

SCALE 1" = 5'	BRIDGE FILE
	DESIGNATION 2001885 & 2101797
SURVEY BOOK	SHEETS 229 of 357
CONTRACT R-43382	PROJECT 2001885

PJV - 2/9/2024 11:50 AM - U:\2021\202124 indot us35\Cad\C3D\Design Files\212443D_CO1.dwg (XS_241_C)

CROSS SECTIONS
Scale 1 inch = 5 feet

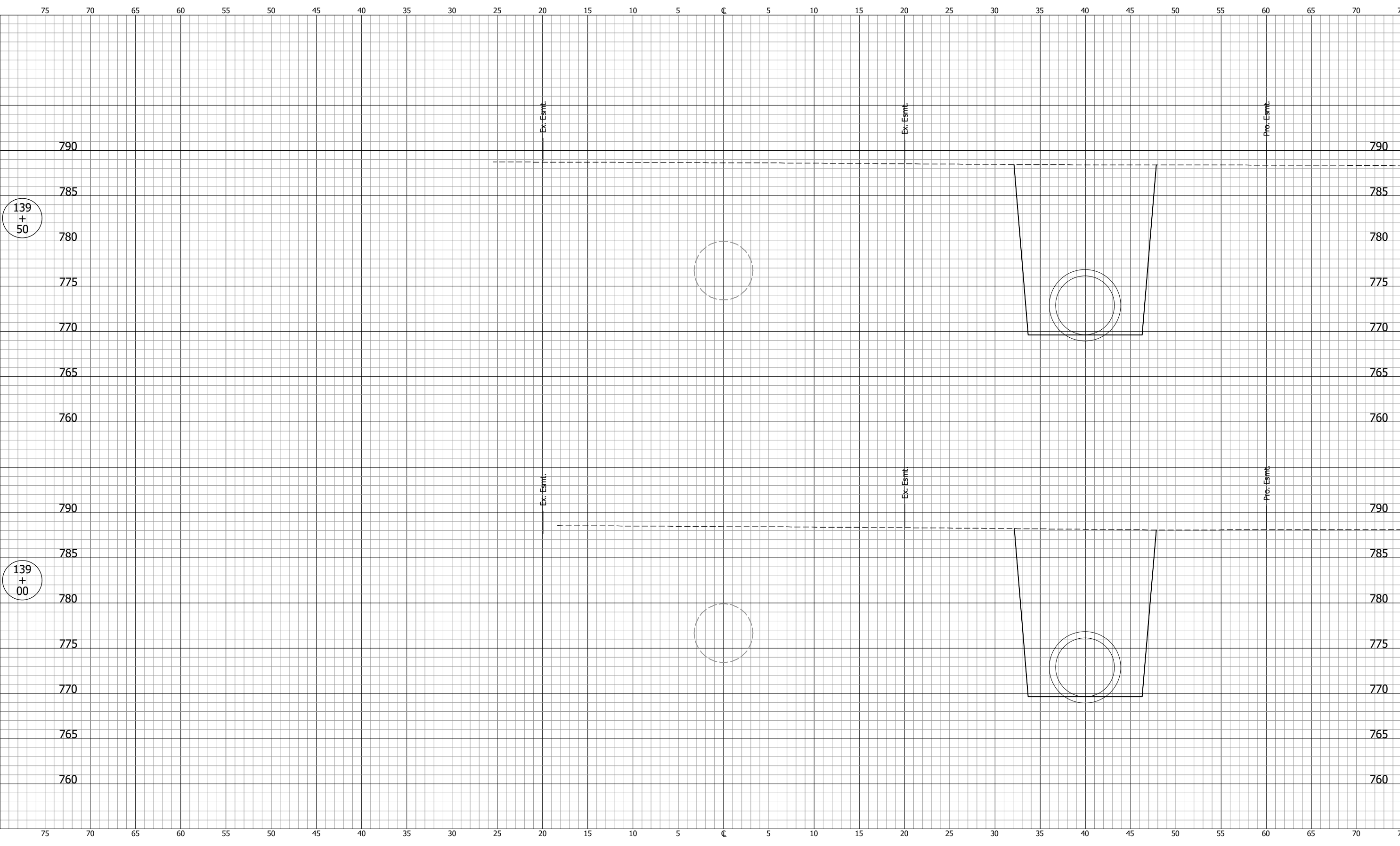

NOT FOR CONSTRUCTION

DESIGNED: DGA	DRAWN: GDH
CHECKED: DGD	CHECKED: DGA

INDIANA
DEPARTMENT OF TRANSPORTATION

**CROSS SECTIONS
LINE "C"**

SCALE 1" = 5'	BRIDGE FILE
	DESIGNATION 2001885 & 2101797
SURVEY BOOK	SHEETS 230 of 357
CONTRACT R-43382	PROJECT 2001885

PJV - 2/9/2024 11:50 AM - U:\2021\202124 indot us35\Cad\C3D\Design Files\2124430_CO1.dwg (XS_242_C)

CROSS SECTIONS
Scale 1 inch = 5 feet

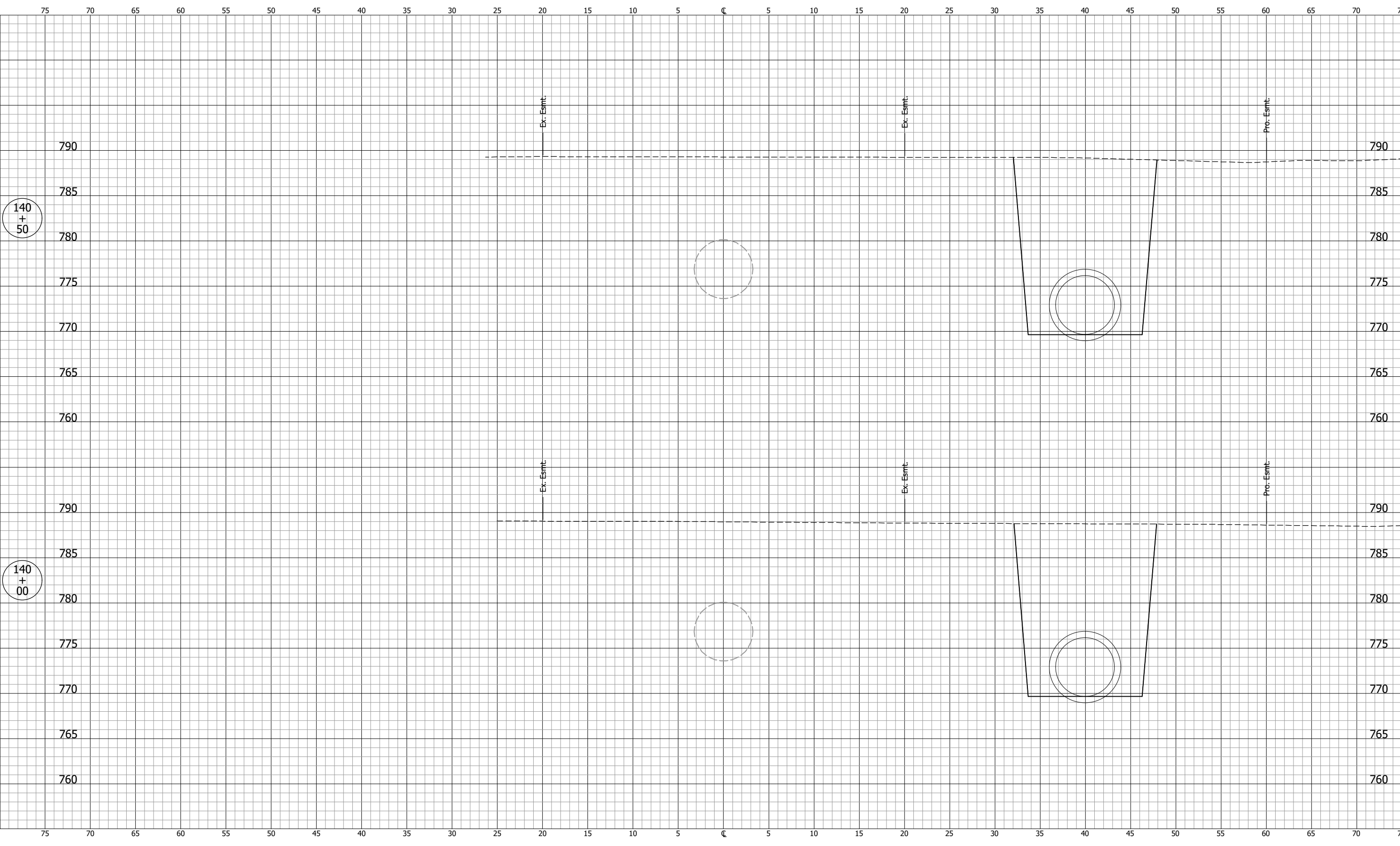

NOT FOR CONSTRUCTION

DESIGNED: DGA	DRAWN: GDH
CHECKED: DGD	CHECKED: DGA

INDIANA
DEPARTMENT OF TRANSPORTATION

**CROSS SECTIONS
LINE "C"**

SCALE 1" = 5'	BRIDGE FILE
	DESIGNATION 2001885 & 2101797
SURVEY BOOK	SHEETS 231 of 357
CONTRACT R-43382	PROJECT 2001885

PJV - 2/9/2024 11:50 AM - U:\2021\2021124 indot us35\Cad\C3D\Design Files\212443D_CO1.dwg (XS_243_C)

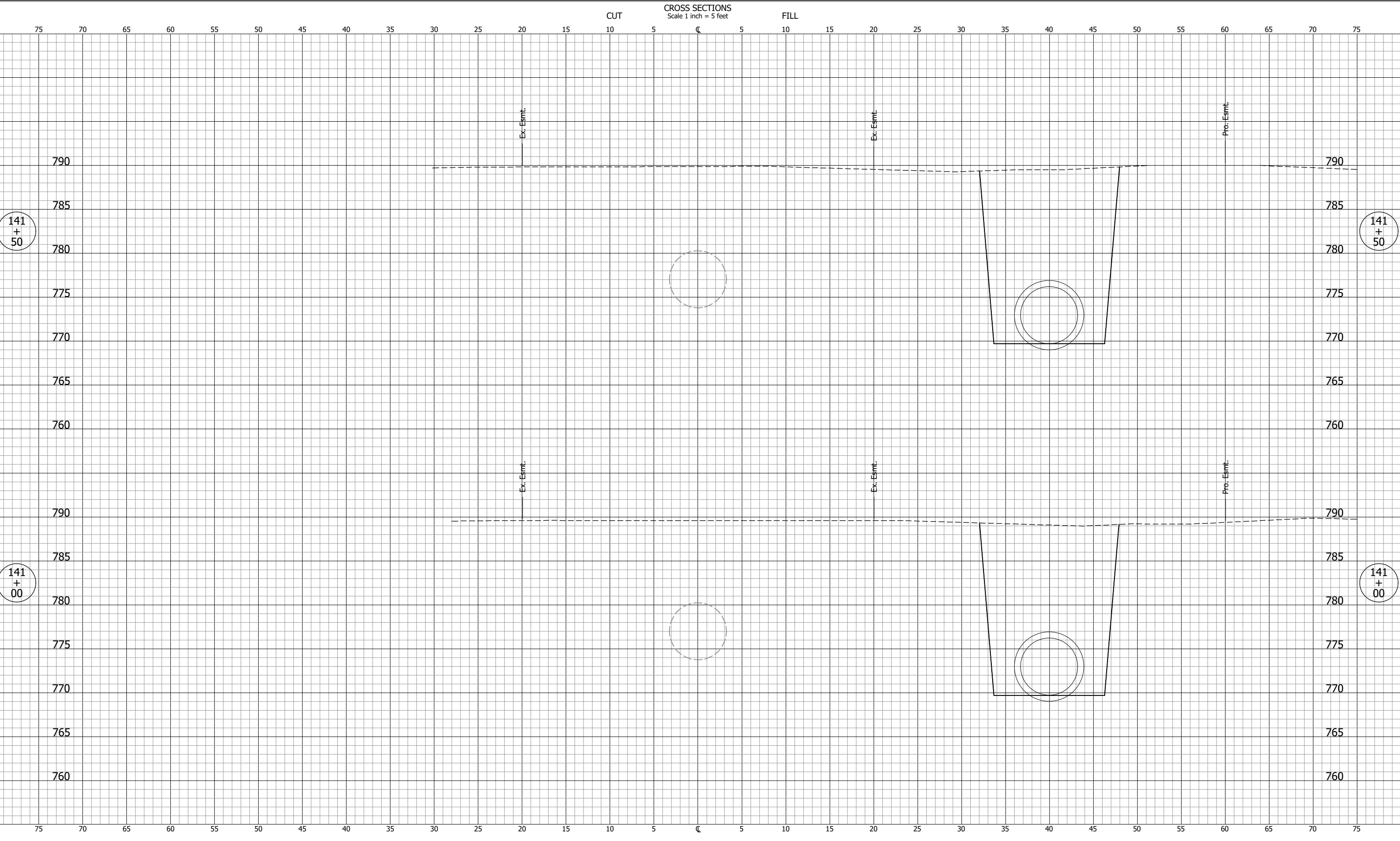

NOT FOR CONSTRUCTION

DESIGNED: DGA	DRAWN: GDH
CHECKED: DGD	CHECKED: DGA

INDIANA
DEPARTMENT OF TRANSPORTATION

**CROSS SECTIONS
LINE "C"**

SCALE 1" = 5'	BRIDGE FILE
	DESIGNATION 2001885 & 2101797
SURVEY BOOK	SHEETS 232 of 357
CONTRACT R-43382	PROJECT 2001885

PJV - 2/9/2024 11:50 AM - U:\2021\2021124 indot us35\Cad\C3D\Design Files\2124430_CO1.dwg (XS_245_C)

CROSS SECTIONS
Scale 1 inch = 5 feet

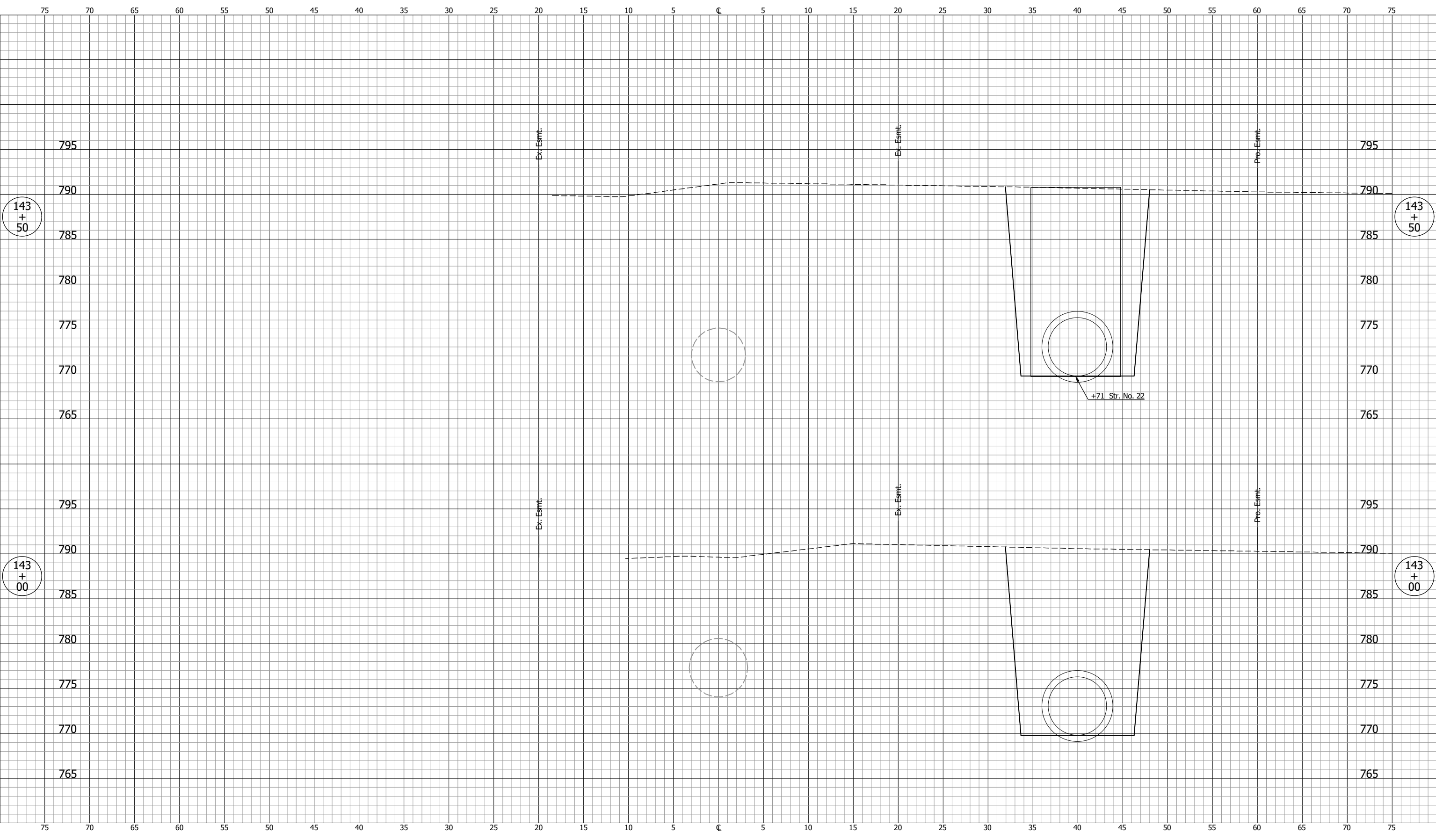

NOT FOR CONSTRUCTION

DESIGNED: DGA	DRAWN: GDH
CHECKED: DGD	CHECKED: DGA

INDIANA
DEPARTMENT OF TRANSPORTATION

**CROSS SECTIONS
LINE "C"**

SCALE 1" = 5'	BRIDGE FILE
	DESIGNATION 2001885 & 2101797
SURVEY BOOK	SHEETS 234 of 357
CONTRACT R-43382	PROJECT 2001885

PJV - 2/9/2024 11:50 AM - U:\2021\202124 indot us35\Cad\C3D\Design Files\2124430_CO1.dwg (XS_246_C)

CROSS SECTIONS
Scale 1 inch = 5 feet

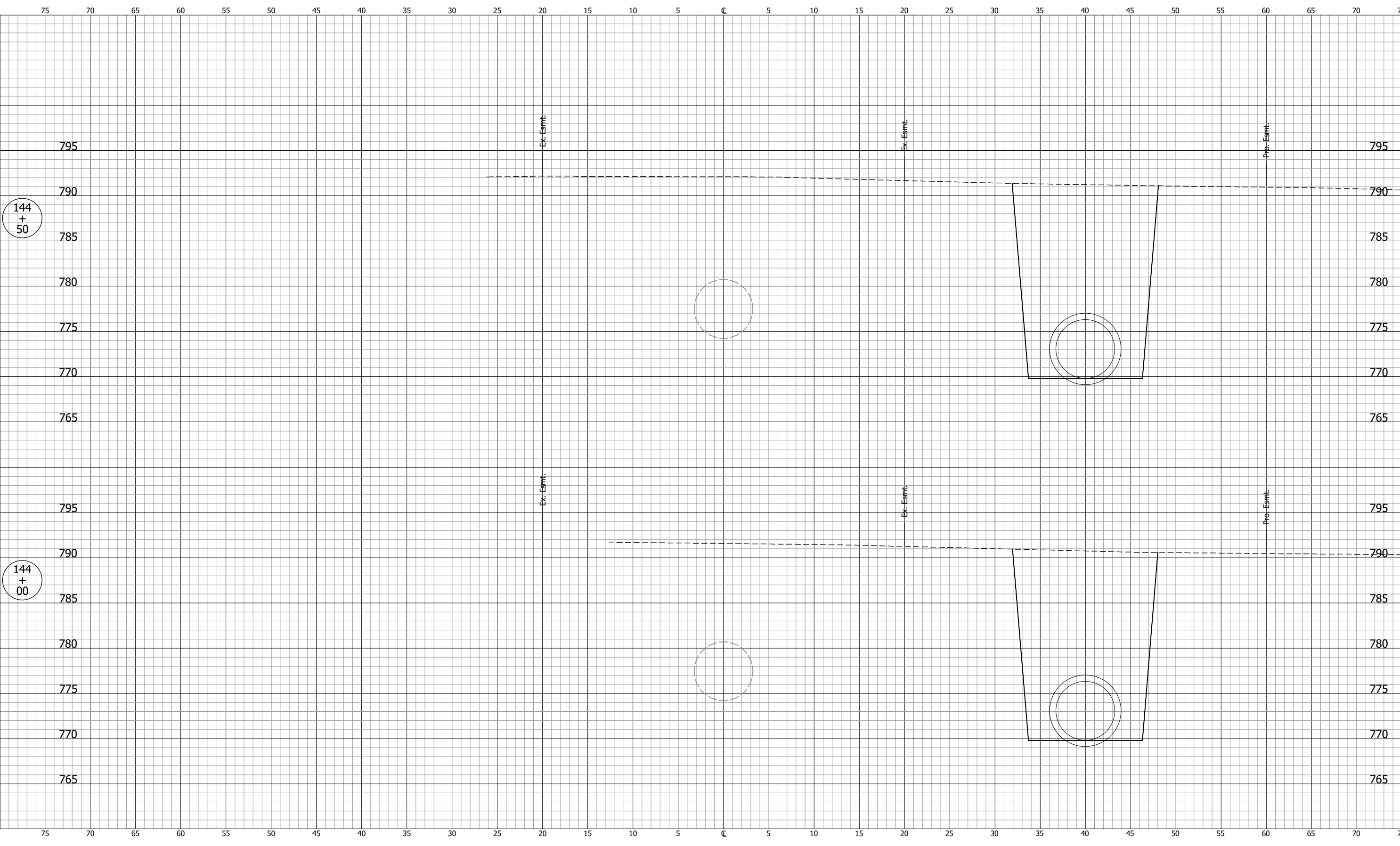

NOT FOR CONSTRUCTION

DESIGNED: DGA	DRAWN: GDH
CHECKED: DGD	CHECKED: DGA

INDIANA
DEPARTMENT OF TRANSPORTATION

**CROSS SECTIONS
LINE "C"**

SCALE 1" = 5'	BRIDGE FILE
	DESIGNATION 2001885 & 2101797
SURVEY BOOK	SHEETS 235 of 357
CONTRACT R-43382	PROJECT 2001885

PJV - 2/9/2024 11:50 AM - U:\2021\2021124 indot us35\Cad\C3D\Design Files\2124430_CO1.dwg (XS_247_C)

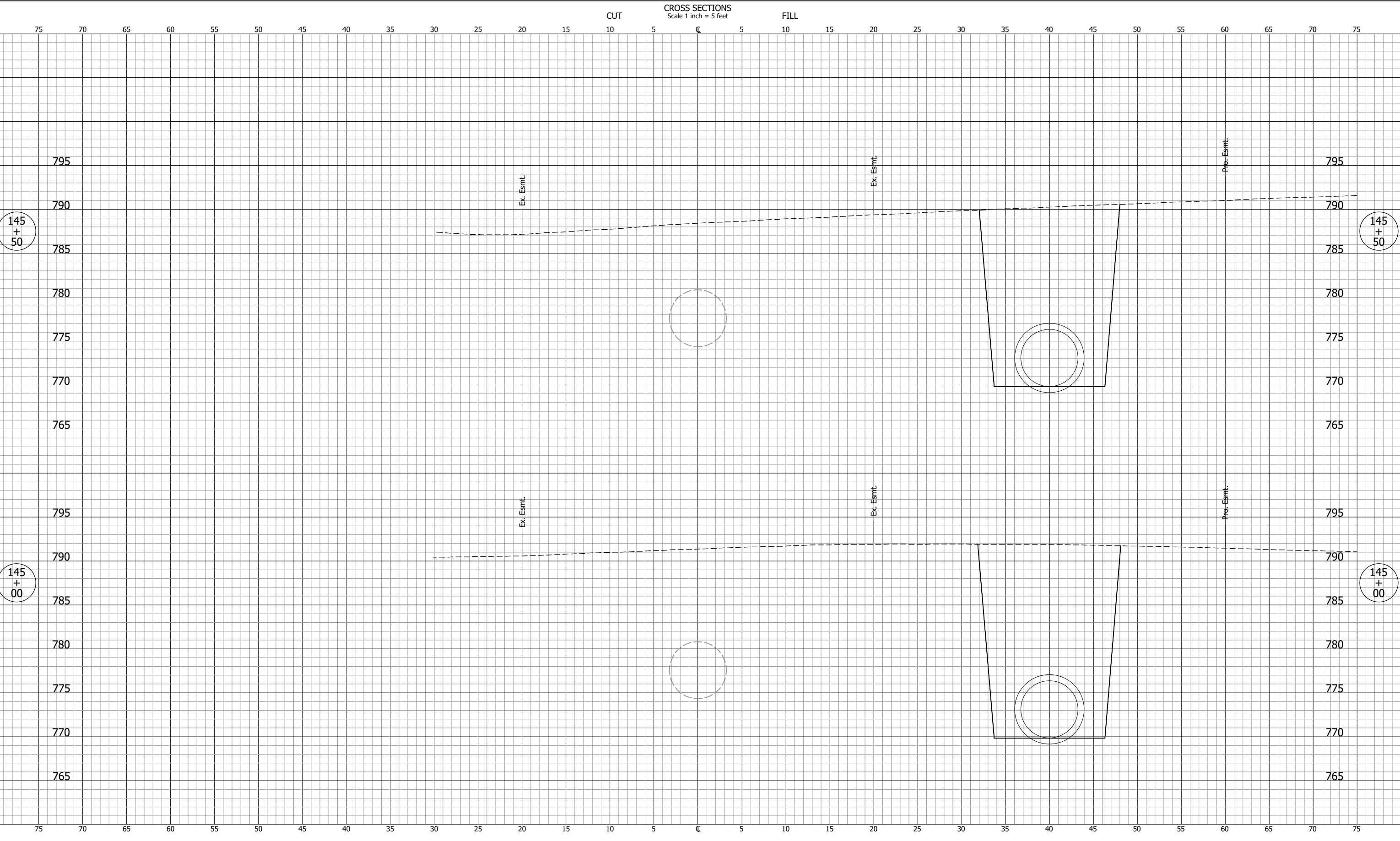

NOT FOR CONSTRUCTION

DESIGNED: DGA	DRAWN: GDH
CHECKED: DGD	CHECKED: DGA

INDIANA
DEPARTMENT OF TRANSPORTATION

**CROSS SECTIONS
LINE "C"**

SCALE 1" = 5'	BRIDGE FILE
	DESIGNATION 2001885 & 2101797
SURVEY BOOK	SHEETS 236 of 357
CONTRACT R-43382	PROJECT 2001885

PJV - 2/9/2024 11:50 AM - U:\2021\2021124 indot us35\Cad\C3D\Design Files\2124430_CO1.dwg (XS_248_C)

CROSS SECTIONS
Scale 1 inch = 5 feet

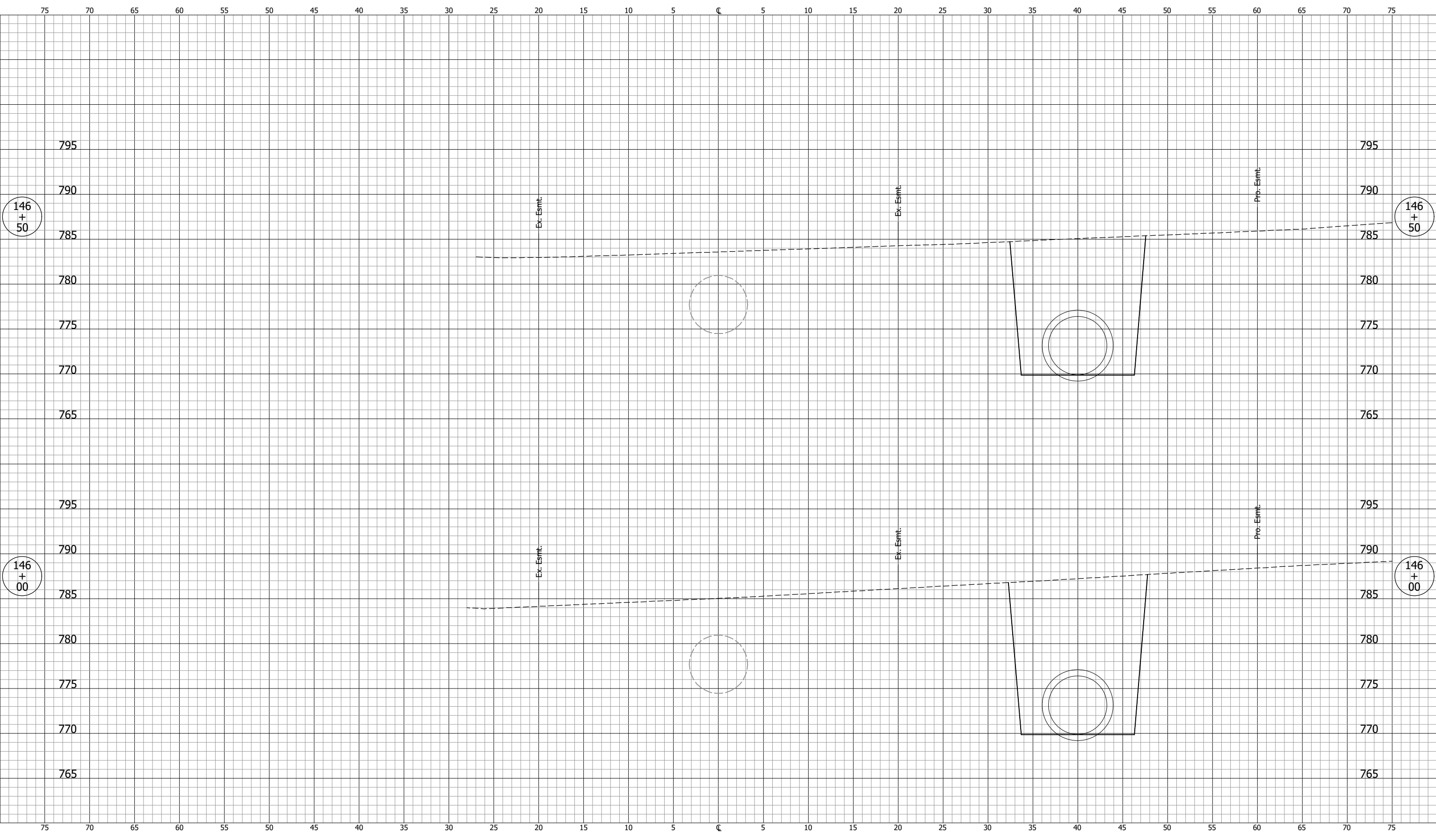

NOT FOR CONSTRUCTION

DESIGNED: DGA	DRAWN: GDH
CHECKED: DGD	CHECKED: DGA

INDIANA
DEPARTMENT OF TRANSPORTATION

**CROSS SECTIONS
LINE "C"**

SCALE 1" = 5'	BRIDGE FILE
	DESIGNATION 2001885 & 2101797
SURVEY BOOK	SHEETS 237 of 357
CONTRACT R-43382	PROJECT 2001885

PJV - 2/9/2024 11:50 AM - U:\2021\2021124 indot us35\Cad\C3D\Design Files\212443D_CO1.dwg (XS_249_C)

CROSS SECTIONS
Scale 1 inch = 5 feet

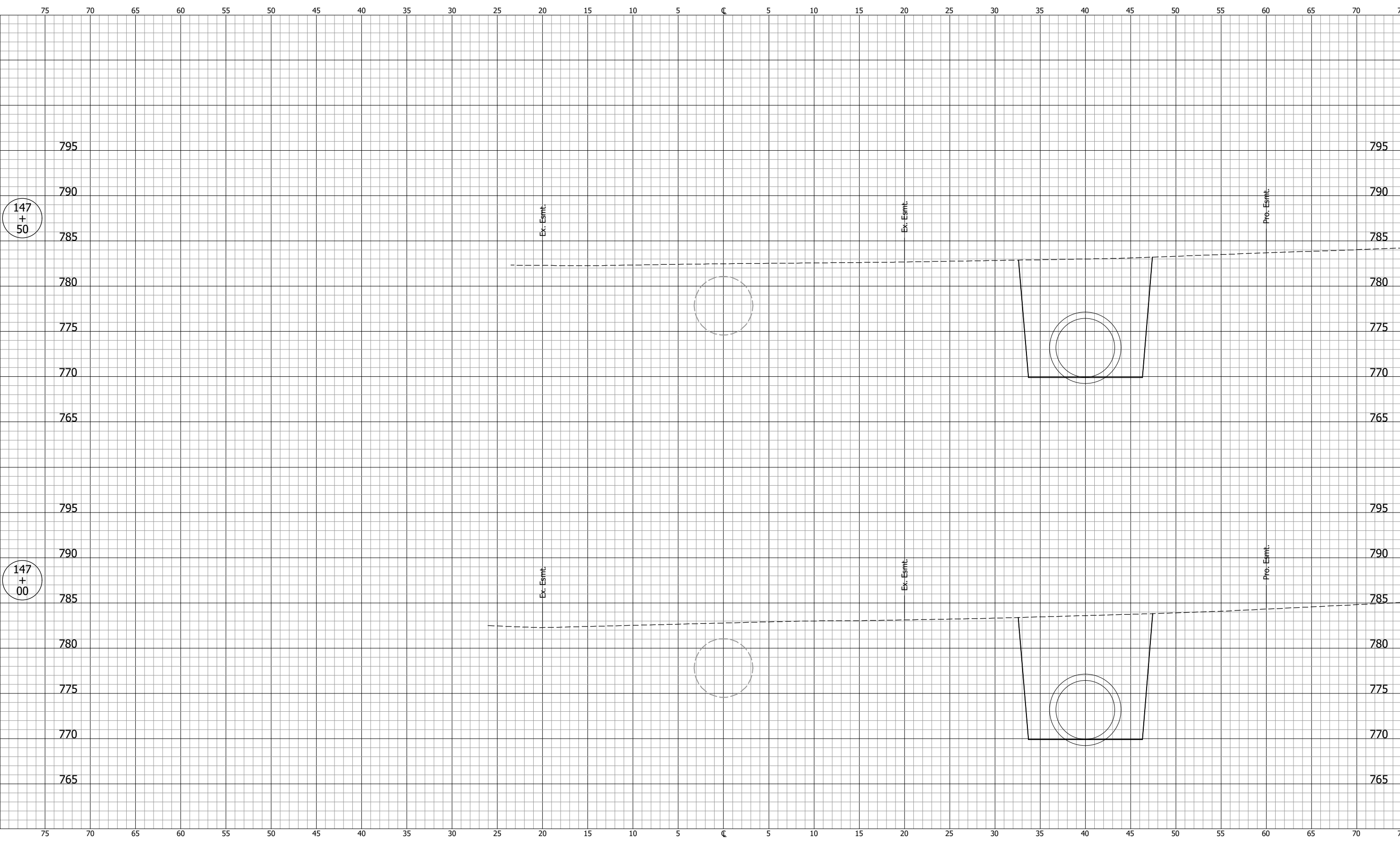

NOT FOR CONSTRUCTION

DESIGNED: DGA DRAWN: GDH
CHECKED: DGD CHECKED: DGA

INDIANA
DEPARTMENT OF TRANSPORTATION

**CROSS SECTIONS
LINE "C"**

SCALE 1" = 5'	BRIDGE FILE
	DESIGNATION 2001885 & 2101797
SURVEY BOOK	SHEETS 238 of 357
CONTRACT R-43382	PROJECT 2001885

CROSS SECTIONS
Scale 1 inch = 5 feet

CUT

FILL

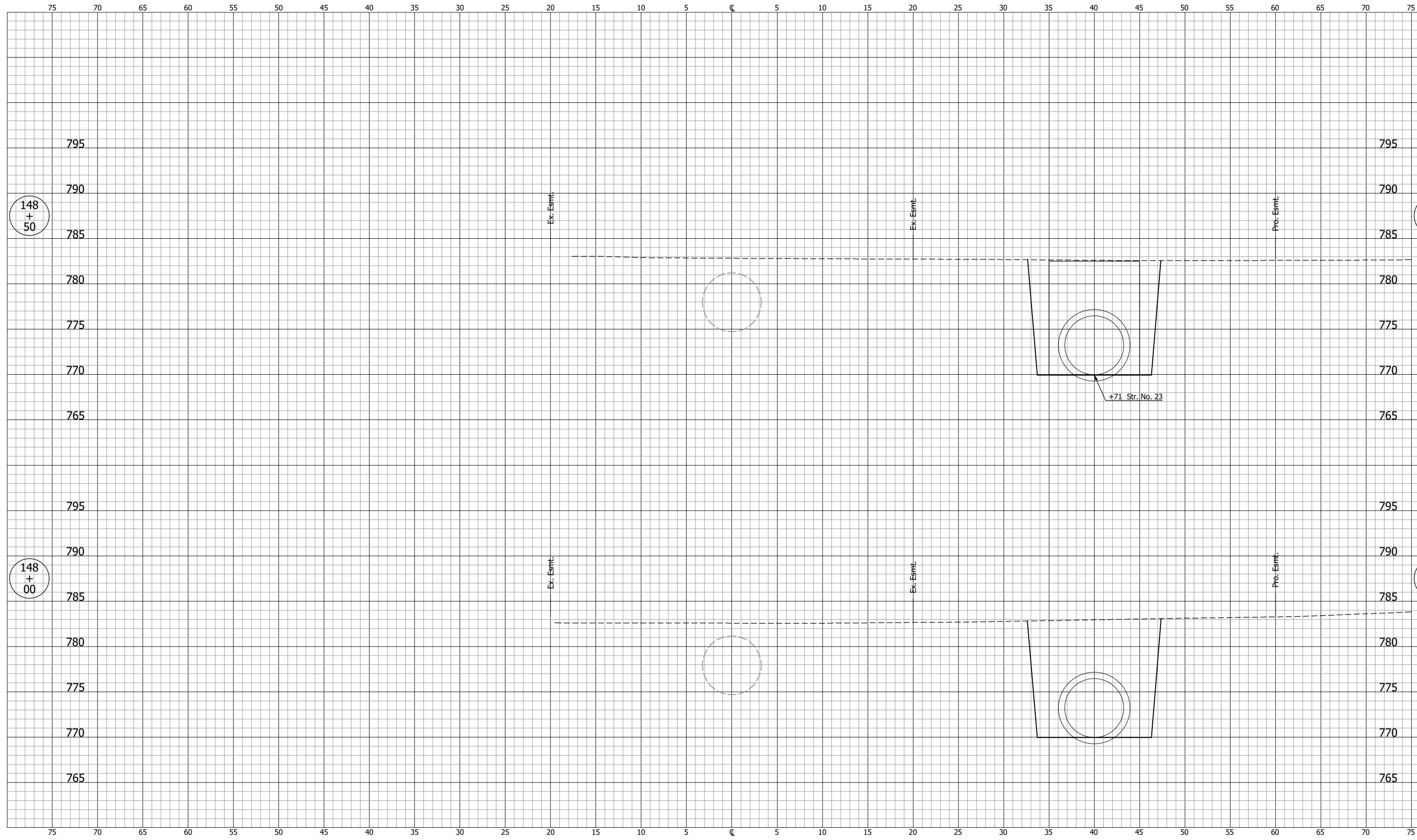

PJV - 2/9/2024 11:50 AM - U:\2021\2021124 indot us35\Cad\C3D\Design Files\2124430_CO1.dwg (XS_250_C)

NOT FOR CONSTRUCTION

DESIGNED: DGA DRAWN: GDH
CHECKED: DGD CHECKED: DGA

INDIANA
DEPARTMENT OF TRANSPORTATION

**CROSS SECTIONS
LINE "C"**

SCALE 1" = 5'	BRIDGE FILE
	DESIGNATION 2001885 & 2101797
SURVEY BOOK	SHEETS 239 of 357
CONTRACT R-43382	PROJECT 2001885

PJV - 2/9/2024 11:51 AM - U:\2021\202124 indot us35\Cad\C3D\Design Files\2124430_CO1.dwg (XS_251_C)

CROSS SECTIONS
Scale 1 inch = 5 feet

CUT

FILL

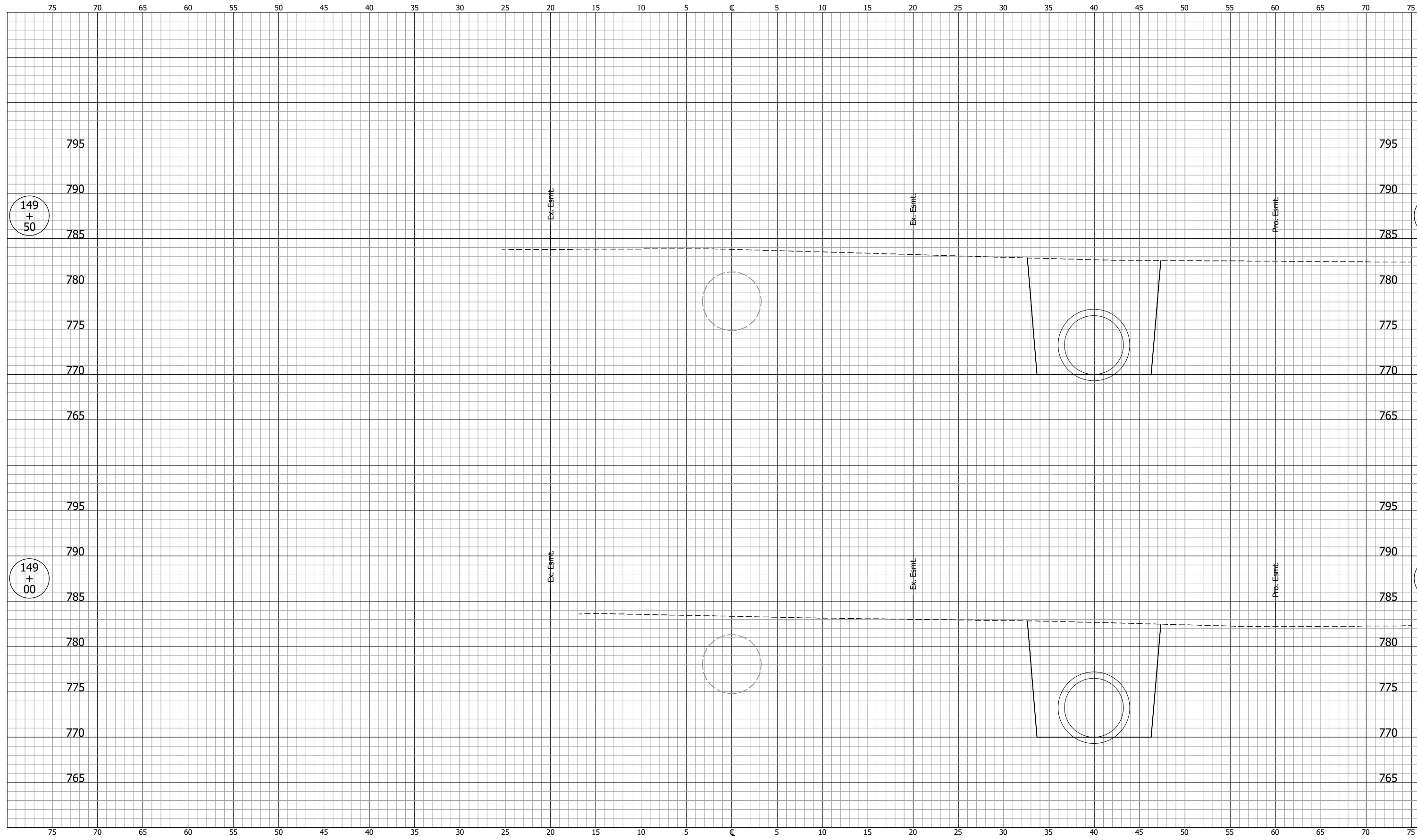

NOT FOR CONSTRUCTION

DESIGNED: DGA	DRAWN: GDH
CHECKED: DGD	CHECKED: DGA

INDIANA
DEPARTMENT OF TRANSPORTATION

**CROSS SECTIONS
LINE "C"**

SCALE 1" = 5'	BRIDGE FILE
	DESIGNATION 2001885 & 2101797
SURVEY BOOK	SHEETS 240 of 357
CONTRACT R-43382	PROJECT 2001885

PJV - 2/9/2024 11:51 AM - U:\2021\2021124 indot us35\Cad\C3D\Design Files\2124430_CO1.dwg (XS_252_C)

CROSS SECTIONS
Scale 1 inch = 5 feet

CUT

FILL

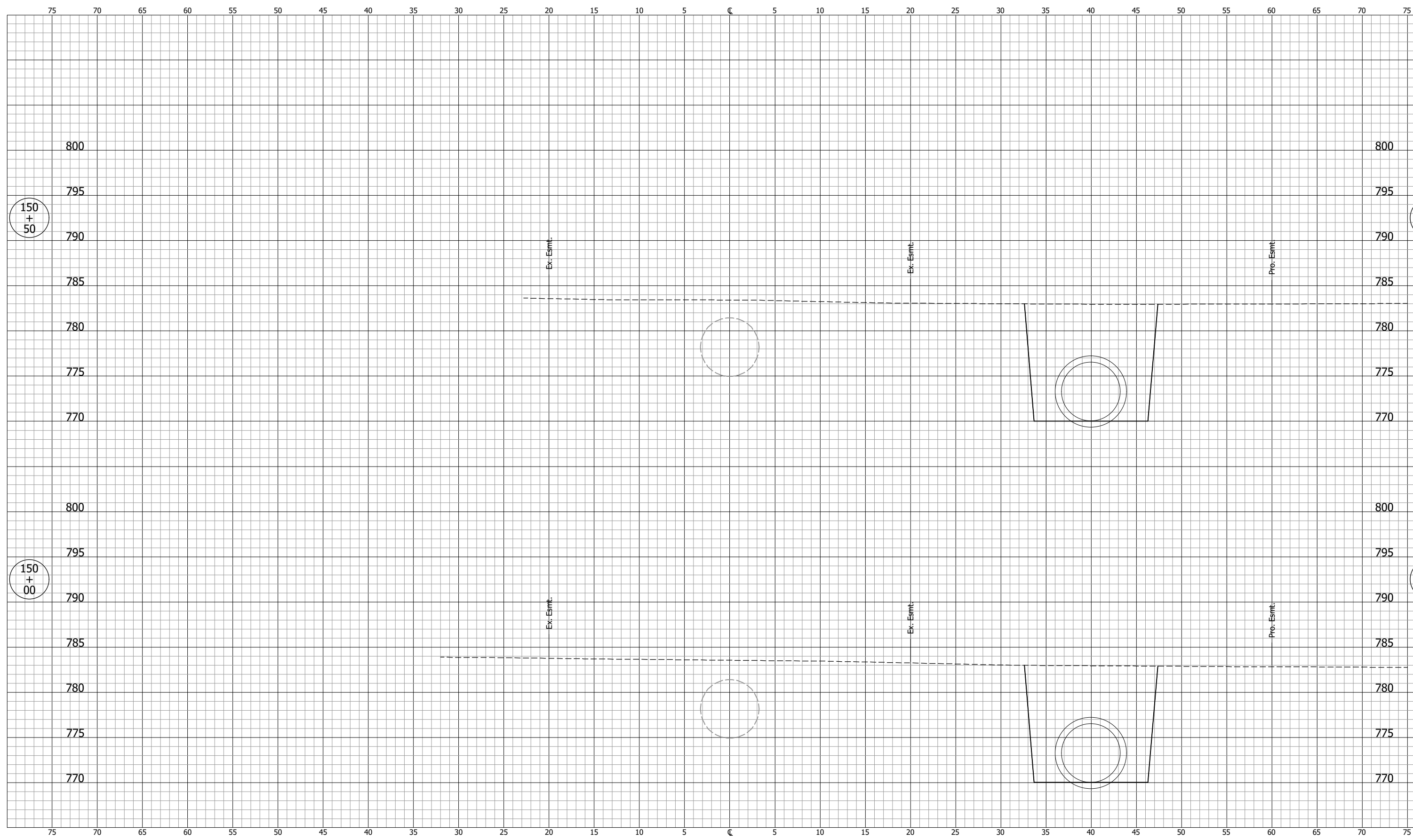

NOT FOR CONSTRUCTION

DESIGNED: DGA DRAWN: GDH
 CHECKED: DGD CHECKED: DGA

INDIANA
DEPARTMENT OF TRANSPORTATION

**CROSS SECTIONS
LINE "C"**

SCALE 1" = 5'	BRIDGE FILE
	DESIGNATION 2001885 & 2101797
SURVEY BOOK	SHEETS 241 of 357
CONTRACT R-43382	PROJECT 2001885

PJV - 2/9/2024 11:51 AM - U:\2021\2021124 indot us35\Cad\C3D\Design Files\212443D_CO1.dwg (XS_254_C)

CROSS SECTIONS
Scale 1 inch = 5 feet

CUT

FILL

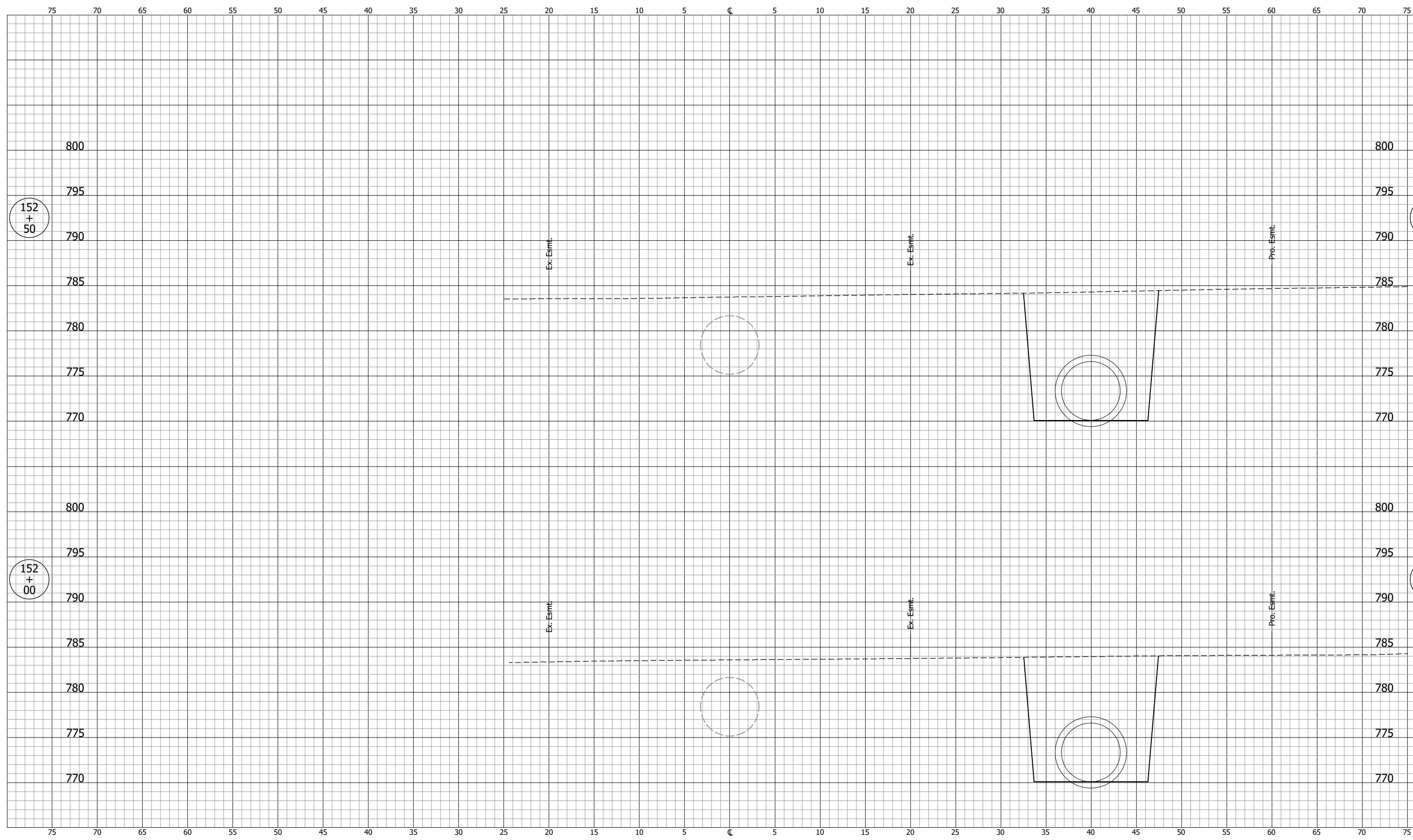

NOT FOR CONSTRUCTION

DESIGNED: DGA	DRAWN: GDH
CHECKED: DGD	CHECKED: DGA

INDIANA
DEPARTMENT OF TRANSPORTATION

**CROSS SECTIONS
LINE "C"**

SCALE 1" = 5'	BRIDGE FILE
	DESIGNATION 2001885 & 2101797
SURVEY BOOK	SHEETS 243 of 357
CONTRACT R-43382	PROJECT 2001885

PJV - 2/9/2024 11:51 AM - U:\2021\2021124 indot us35\Cad\C3D\Design Files\2124430_CO1.dwg (XS_255_C)

CROSS SECTIONS
Scale 1 inch = 5 feet

CUT

FILL

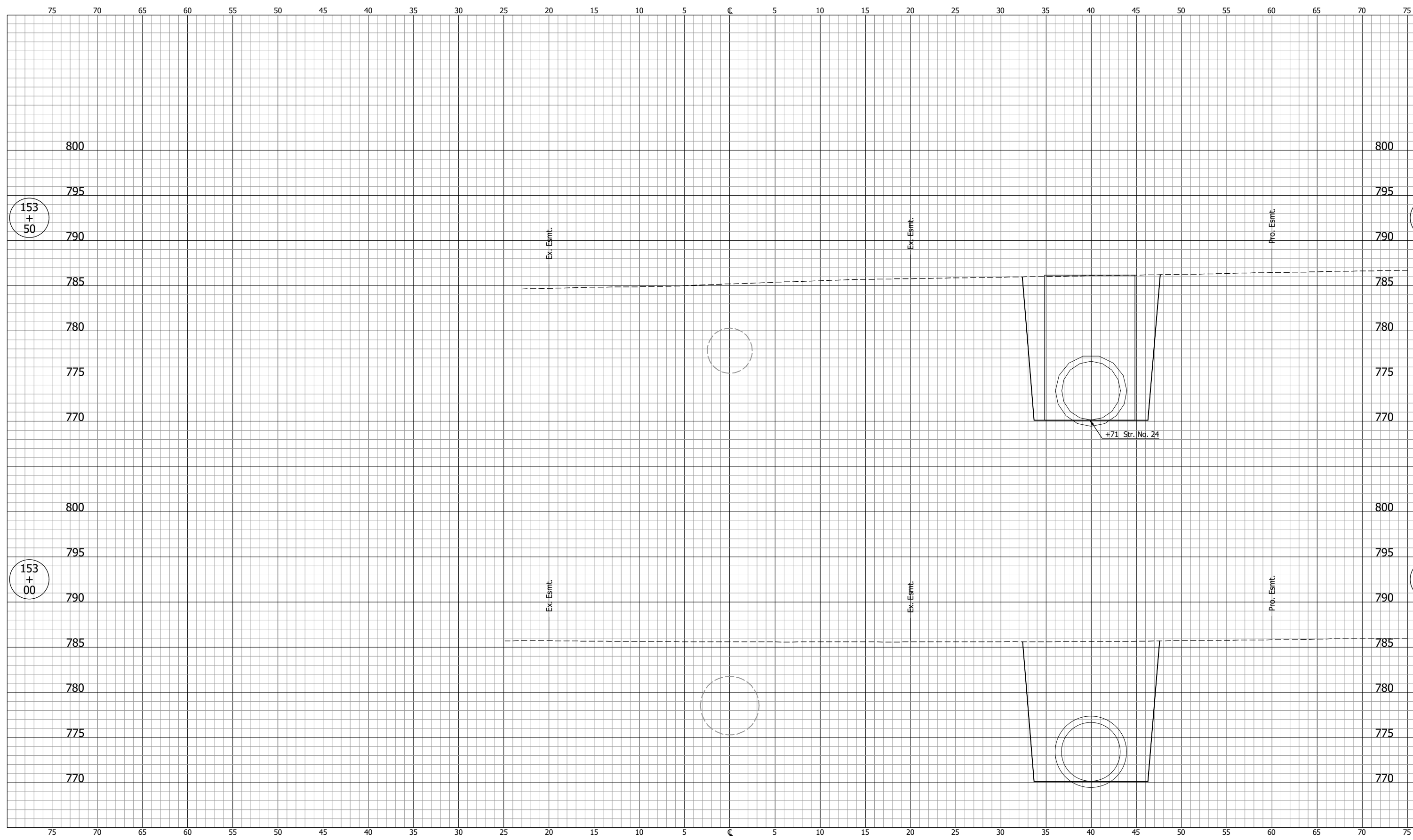

NOT FOR CONSTRUCTION

DESIGNED: DGA DRAWN: GDH
CHECKED: DGD CHECKED: DGA

INDIANA
DEPARTMENT OF TRANSPORTATION

**CROSS SECTIONS
LINE "C"**

SCALE 1" = 5'	BRIDGE FILE
	DESIGNATION 2001885 & 2101797
SURVEY BOOK	SHEETS 244 of 357
CONTRACT R-43382	PROJECT 2001885

PJV - 2/9/2024 11:51 AM - U:\2021\202124 indot us35\Cad\C3D\Design Files\212443D_CO1.dwg (XS_257_C)

CROSS SECTIONS
Scale 1 inch = 5 feet

CUT

FILL

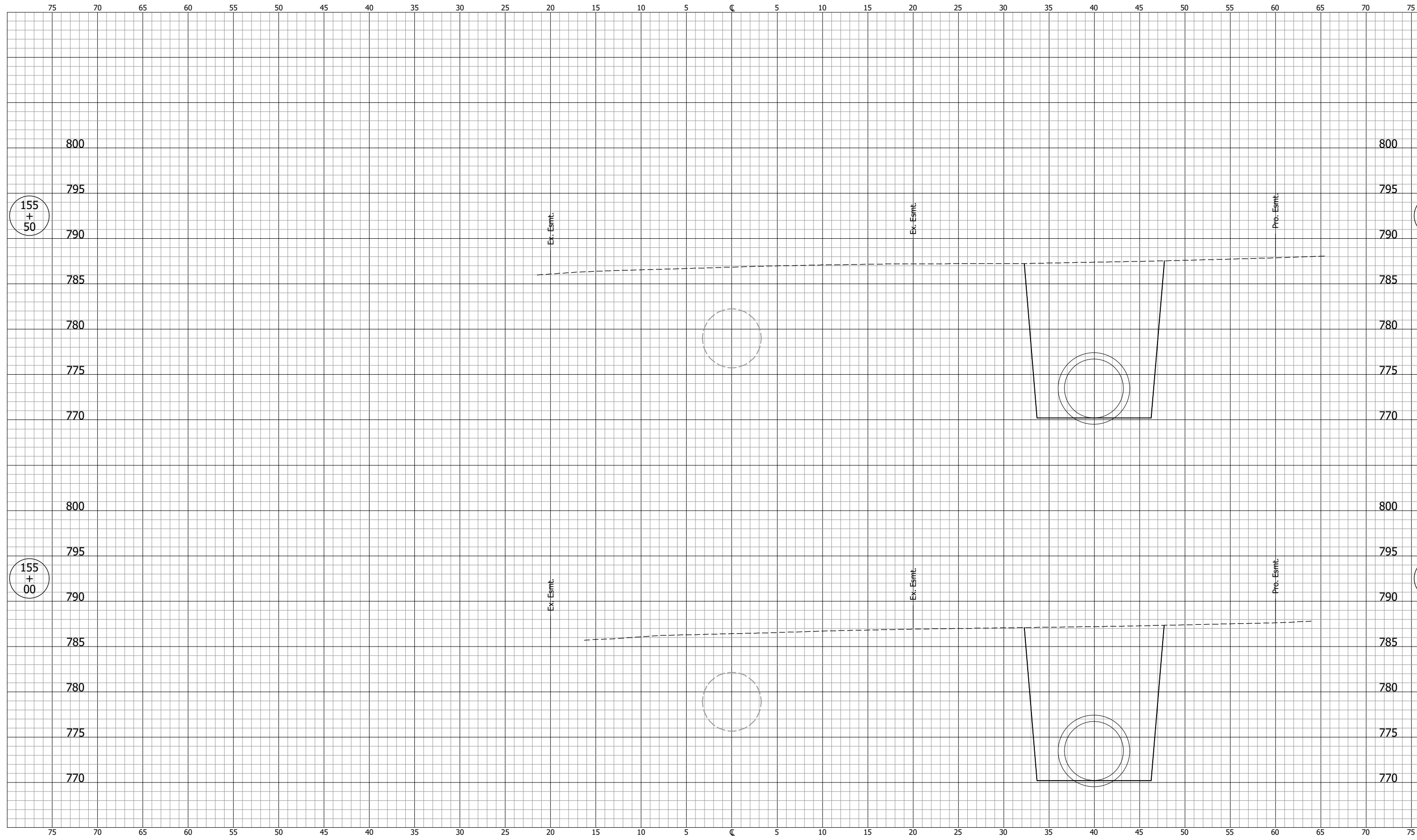

NOT FOR CONSTRUCTION

DESIGNED: DGA	DRAWN: GDH
CHECKED: DGD	CHECKED: DGA

INDIANA
DEPARTMENT OF TRANSPORTATION

**CROSS SECTIONS
LINE "C"**

SCALE 1" = 5'	BRIDGE FILE
	DESIGNATION 2001885 & 2101797
SURVEY BOOK	SHEETS 246 of 357
CONTRACT R-43382	PROJECT 2001885

PJV - 2/9/2024 11:51 AM - U:\2021\2021124 indot us35\Cad\C3D\Design Files\212443D_CO1.dwg (XS_258_C)

CROSS SECTIONS
Scale 1 inch = 5 feet

CUT

FILL

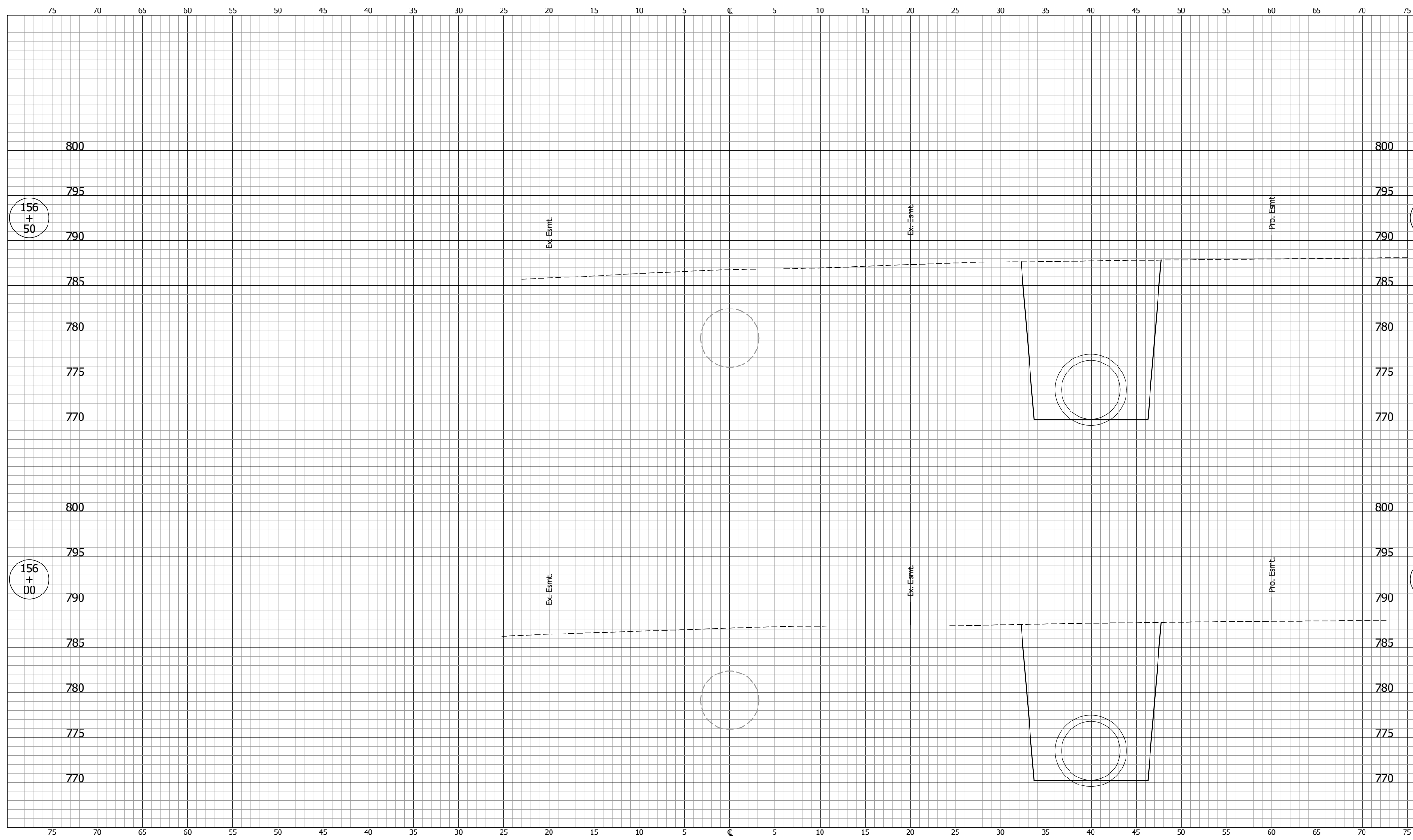

NOT FOR CONSTRUCTION		INDIANA DEPARTMENT OF TRANSPORTATION		SCALE 1" = 5'	BRIDGE FILE
		CROSS SECTIONS LINE "C"		DESIGNATION 2001885 & 2101797	
SURVEY BOOK	SHEETS				
CONTRACT R-43382	247			of	357
DESIGNED: DGA	DRAWN: GDH			PROJECT 2001885	
CHECKED: DGD	CHECKED: DGA				

PJV - 2/9/2024 11:51 AM - U:\2021\202124 indot us35\Cad\C3D\Design Files\212443D_CO1.dwg (XS_259_C)

CROSS SECTIONS
Scale 1 inch = 5 feet

CUT

FILL

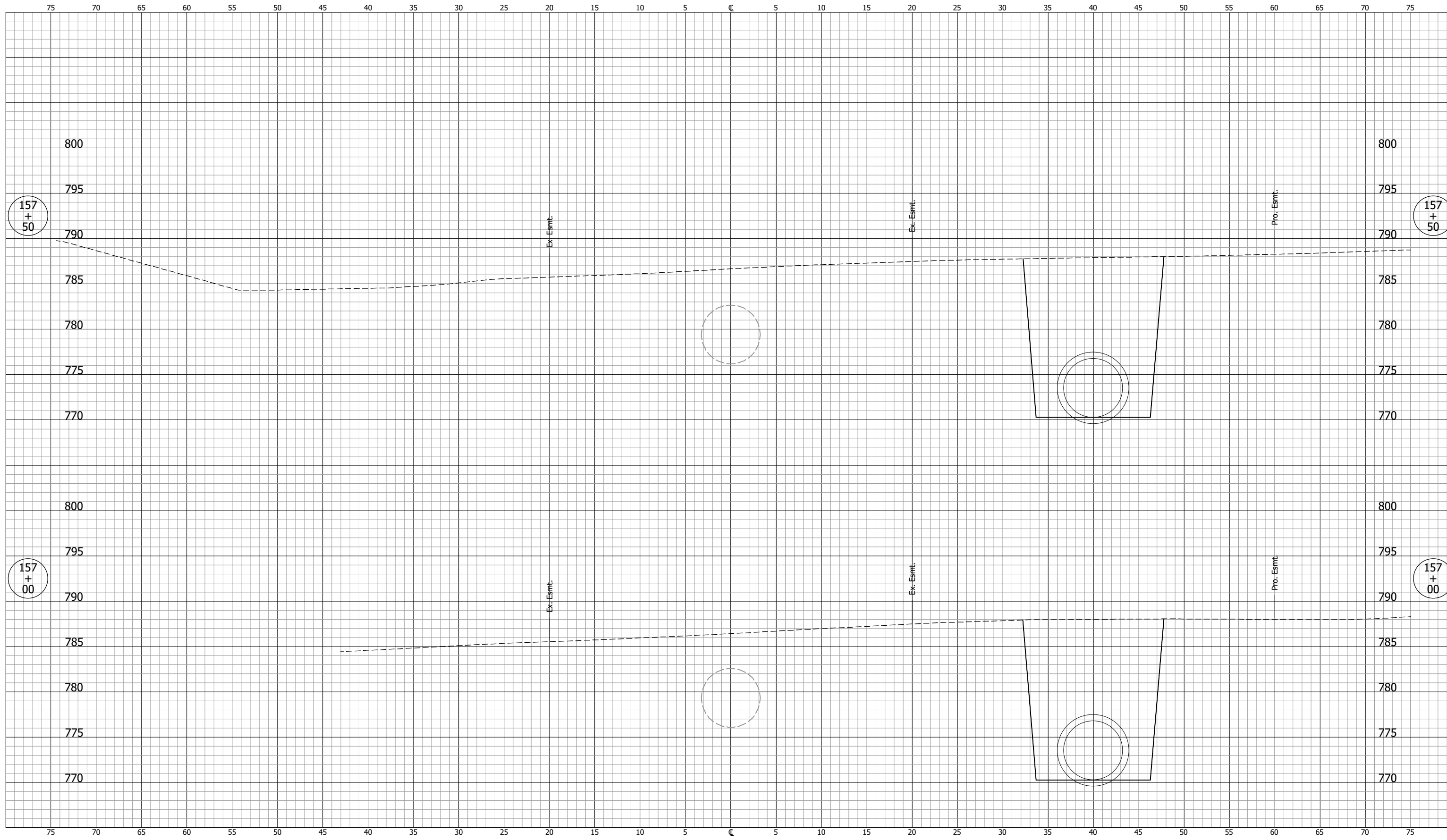

NOT FOR CONSTRUCTION

DESIGNED: DGA	DRAWN: GDH
CHECKED: DGD	CHECKED: DGA

INDIANA
DEPARTMENT OF TRANSPORTATION

**CROSS SECTIONS
LINE "C"**

SCALE 1" = 5'	BRIDGE FILE
	DESIGNATION 2001885 & 2101797
SURVEY BOOK	SHEETS 248 of 357
CONTRACT R-43382	PROJECT 2001885

PJV - 2/9/2024 11:51 AM - U:\2021\2021124 indot us35\Cad\C3D\Design Files\212443D_CO1.dwg (XS_260_C)

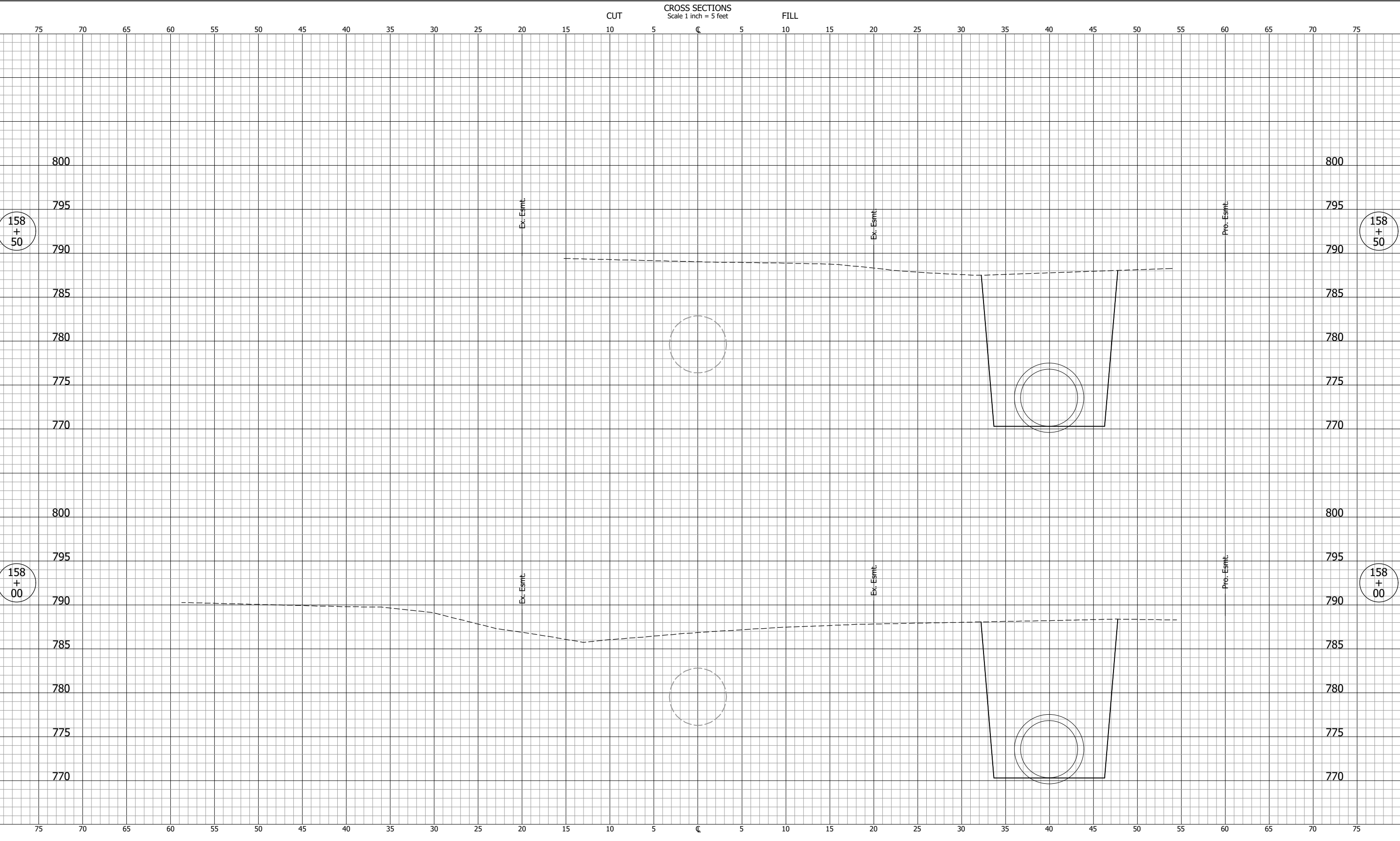

NOT FOR CONSTRUCTION

DESIGNED: DGA	DRAWN: GDH
CHECKED: DGD	CHECKED: DGA

INDIANA
DEPARTMENT OF TRANSPORTATION

**CROSS SECTIONS
LINE "C"**

SCALE 1" = 5'	BRIDGE FILE
	DESIGNATION 2001885 & 2101797
SURVEY BOOK	SHEETS 249 of 357
CONTRACT R-43382	PROJECT 2001885

PJV - 2/9/2024 11:51 AM - U:\2021\202124 indot us35\Cad\C3D\Design Files\212443D_CO1.dwg (XS_261_B=1)

CROSS SECTIONS
Scale 1 inch = 5 feet

CUT

FILL

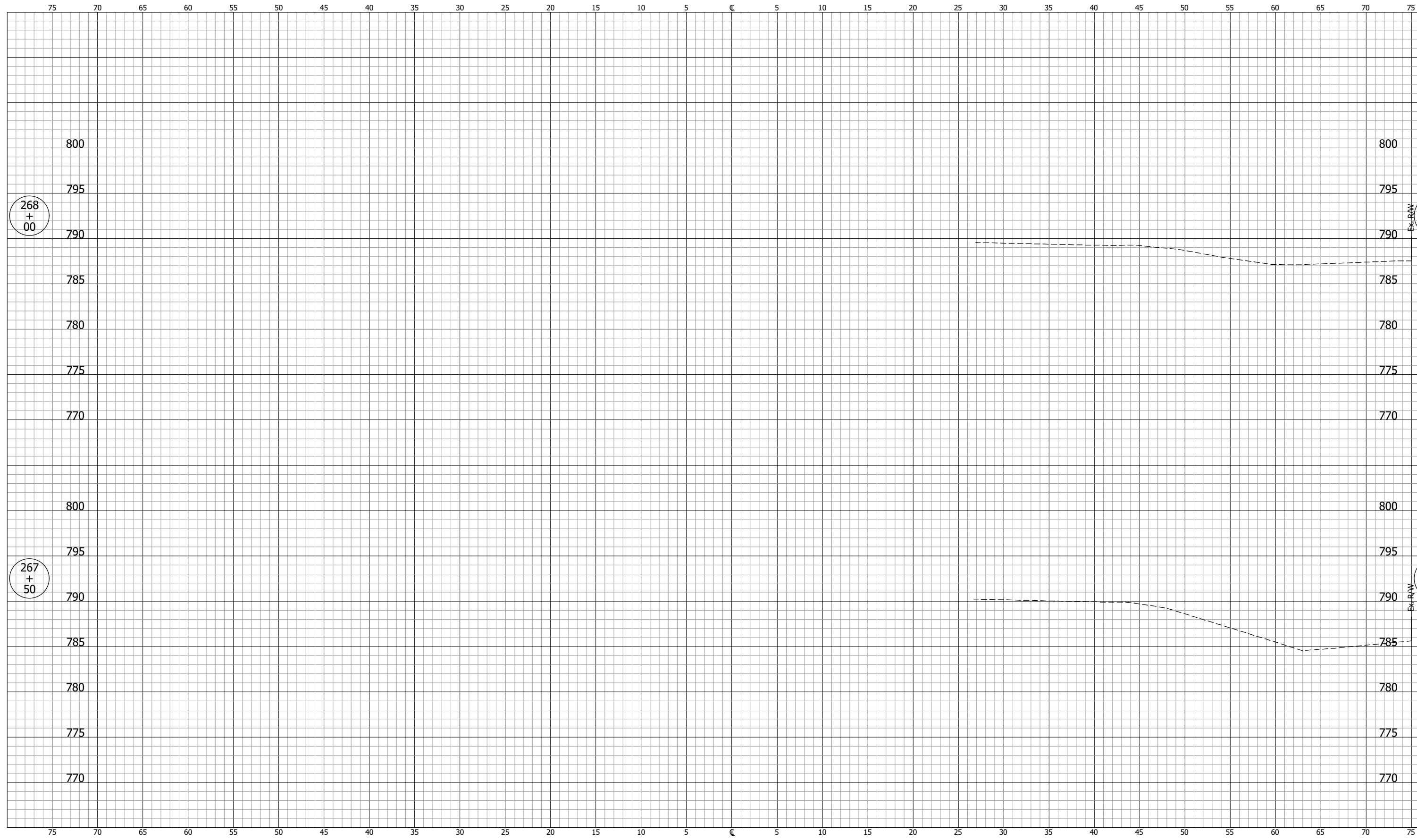

NOT FOR CONSTRUCTION

DESIGNED: DGA DRAWN: GDH
CHECKED: DGD CHECKED: DGA

INDIANA
DEPARTMENT OF TRANSPORTATION

**CROSS SECTIONS
LINE "B-1"**

SCALE 1" = 5'	BRIDGE FILE
	DESIGNATION 2001885 & 2101797
SURVEY BOOK	SHEETS 250 of 357
CONTRACT R-43382	PROJECT 2001885

CROSS SECTIONS
Scale 1 inch = 5 feet

CUT

FILL

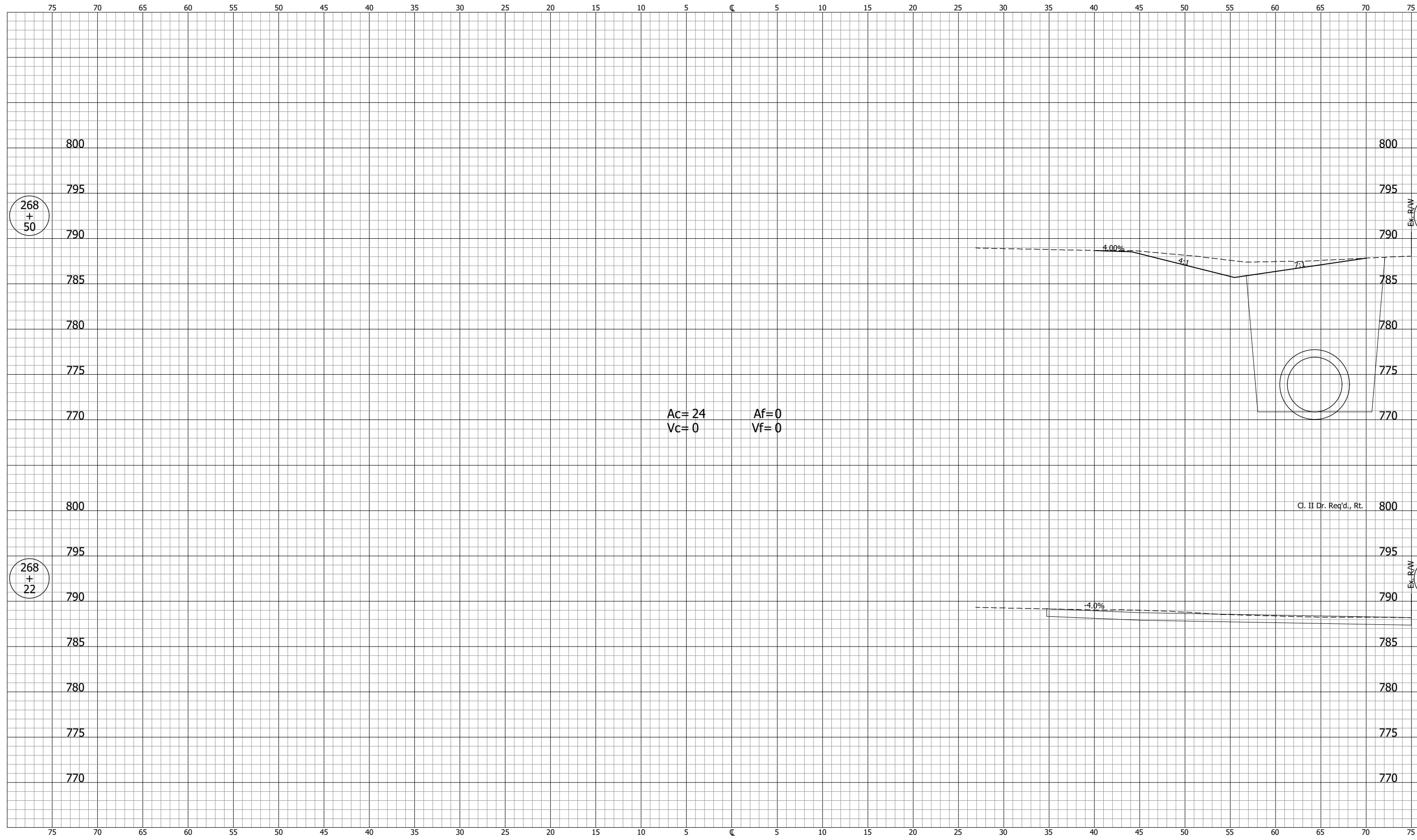

PJV - 2/9/2024 11:51 AM - U:\2021\202124 indot us35\Cad\C3D\Design Files\2124430_CO1.dwg (XS_262_B=1)

NOT FOR CONSTRUCTION		INDIANA DEPARTMENT OF TRANSPORTATION		SCALE	BRIDGE FILE
				1" = 5'	
DESIGNED: DGA DRAWN: GDH		CROSS SECTIONS LINE "B-1"		DESIGNATION	
				2001885 & 2101797	
CHECKED: DGD CHECKED: DGA				SURVEY BOOK	SHEETS
				CONTRACT	PROJECT
				R-43382	251 of 357 2001885

PJV - 2/9/2024 11:52 AM - U:\2021\2021124 indot us35\Cad\C3D\Design Files\212443D_CO1.dwg (XS_263_B-1)

CROSS SECTIONS
Scale 1 inch = 5 feet

CUT

FILL

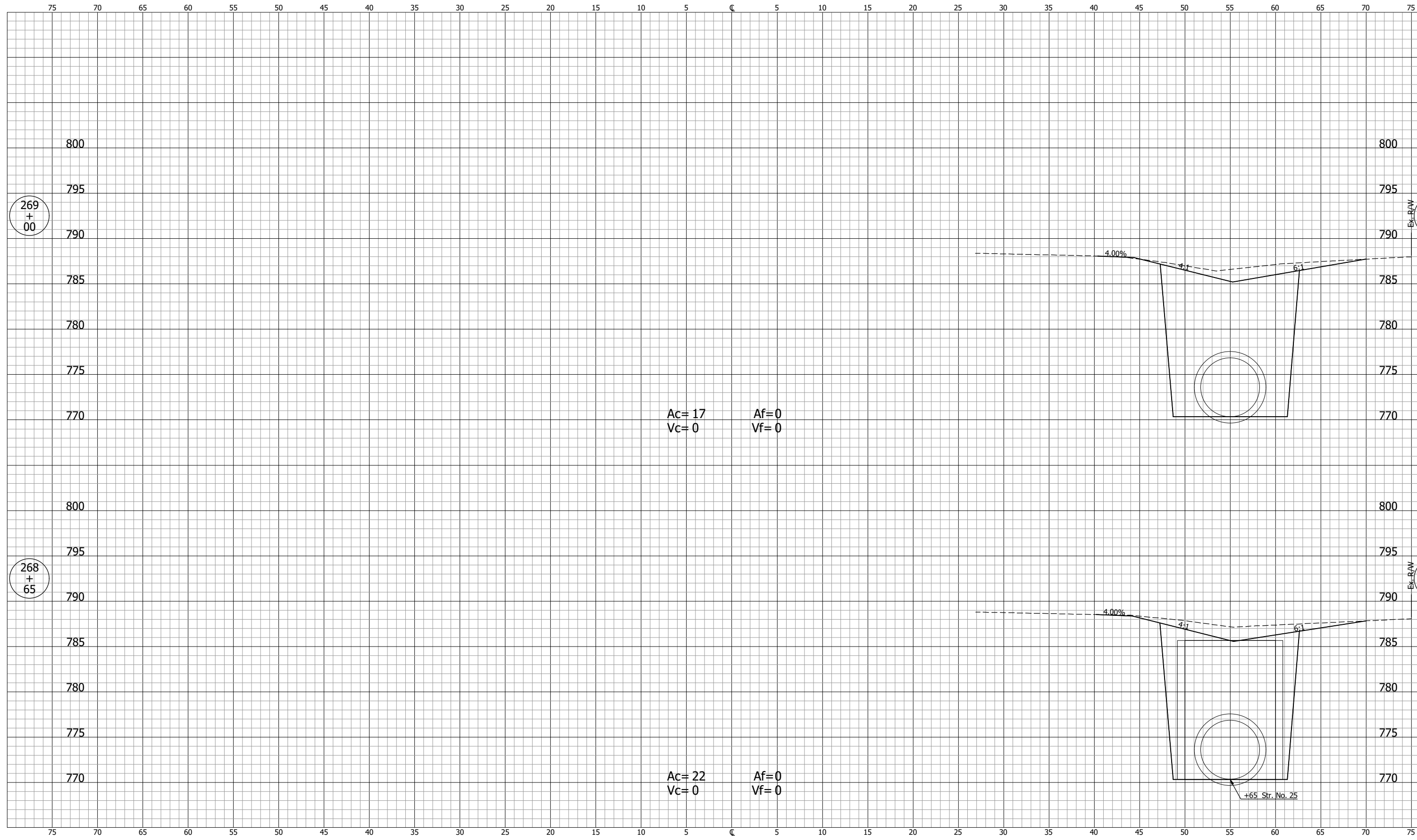

Ac= 17
Vc= 0

Af= 0
Vf= 0

Ac= 22
Vc= 0

Af= 0
Vf= 0

NOT FOR CONSTRUCTION

INDIANA
DEPARTMENT OF TRANSPORTATION

DESIGNED: DGA DRAWN: GDH
CHECKED: DGD CHECKED: DGA

CROSS SECTIONS
LINE "B-1"

SCALE 1" = 5'	BRIDGE FILE
	DESIGNATION 2001885 & 2101797
SURVEY BOOK	SHEETS 252 of 357
CONTRACT R-43382	PROJECT 2001885

CROSS SECTIONS
Scale 1 inch = 5 feet

CUT

FILL

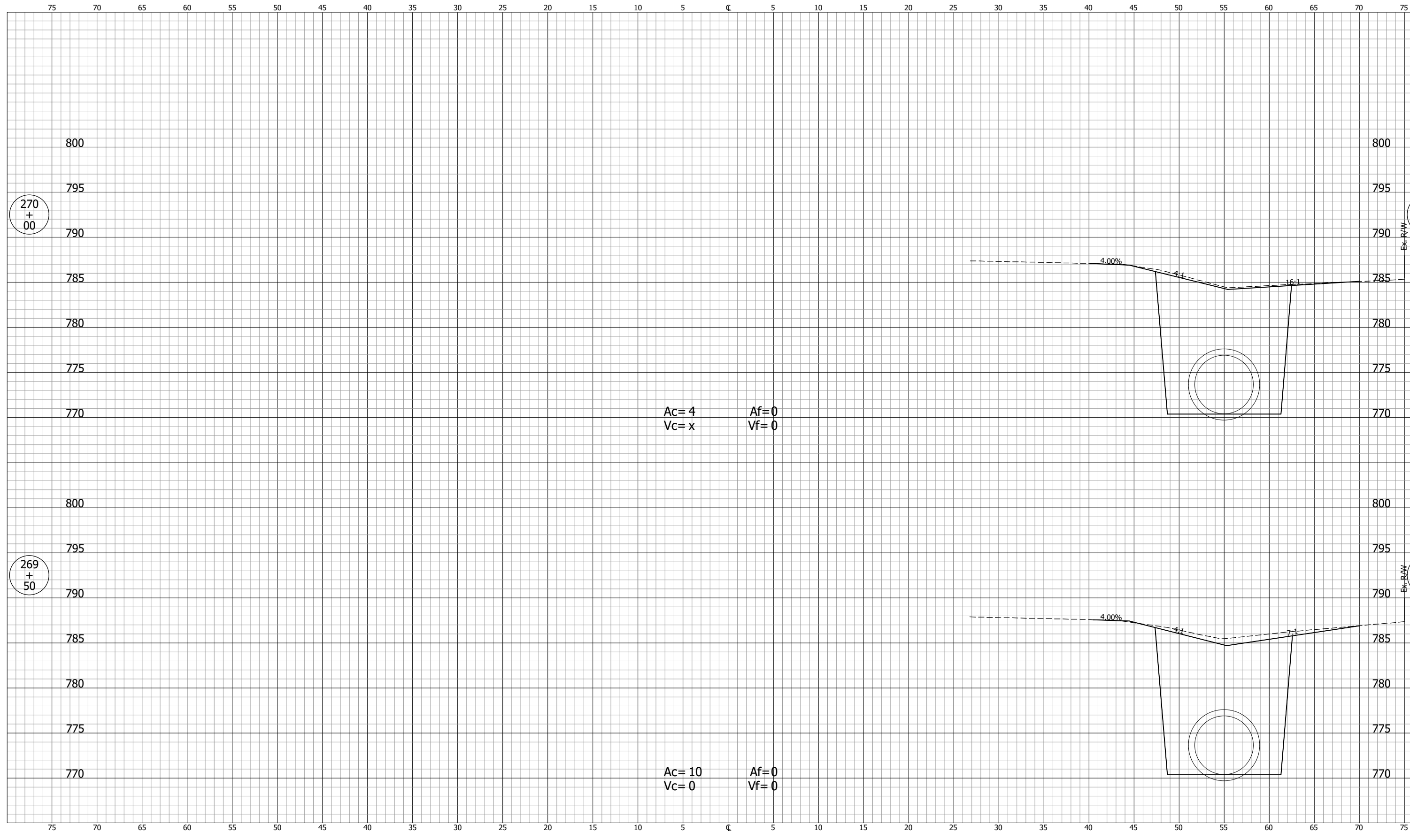

Ac= 4 Af=0
Vc= x Vf= 0

Ac= 10 Af=0
Vc= 0 Vf= 0

270
+
00

270
+
00

269
+
50

269
+
50

NOT FOR CONSTRUCTION

INDIANA
DEPARTMENT OF TRANSPORTATION

DESIGNED: DGA DRAWN: GDH
CHECKED: DGD CHECKED: DGA

CROSS SECTIONS
LINE "B-1"

SCALE 1" = 5'	BRIDGE FILE
	DESIGNATION 2001885 & 2101797
SURVEY BOOK	SHEETS 253 of 357
CONTRACT R-43382	PROJECT 2001885

PJV - 2/9/2024 11:52 AM - U:\2021\2021124 indot us35\Cad\C3D\Design Files\212443D_CO1.dwg (XS_265_B-1)

CROSS SECTIONS
Scale 1 inch = 5 feet

CUT

FILL

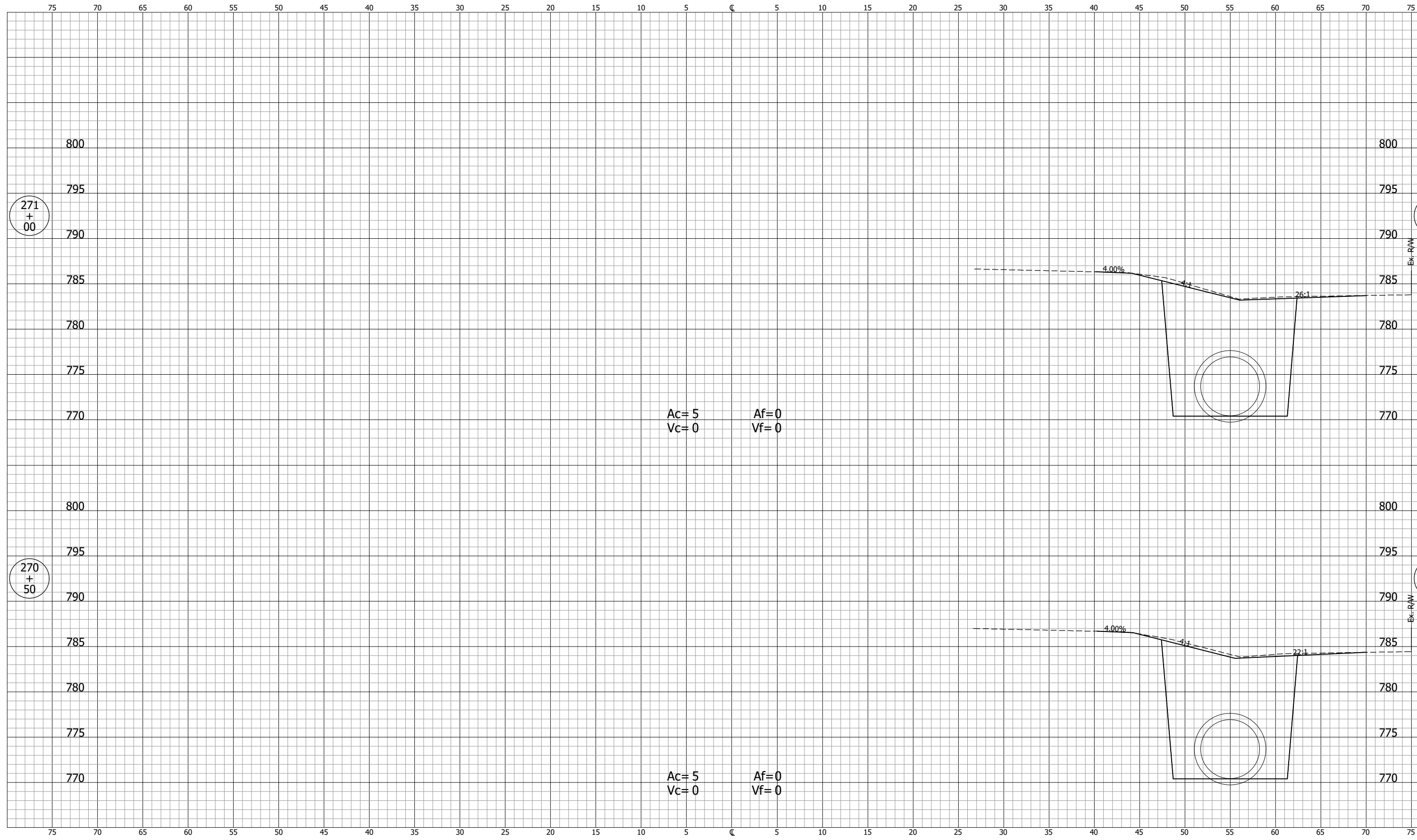

Ac=5 Af=0
Vc=0 Vf=0

Ac=5 Af=0
Vc=0 Vf=0

NOT FOR CONSTRUCTION		INDIANA DEPARTMENT OF TRANSPORTATION		SCALE 1" = 5'	BRIDGE FILE
		CROSS SECTIONS LINE "B-1"		DESIGNATION 2001885 & 2101797	
SURVEY BOOK	SHEETS				
CONTRACT R-43382	254 of 357 PROJECT 2001885				

PJV - 2/9/2024 11:52 AM - U:\2021\2021124 indot us35\Cad\C3D\Design Files\2124430_CO1.dwg (XS_266_B-1)

CROSS SECTIONS
Scale 1 inch = 5 feet

CUT

FILL

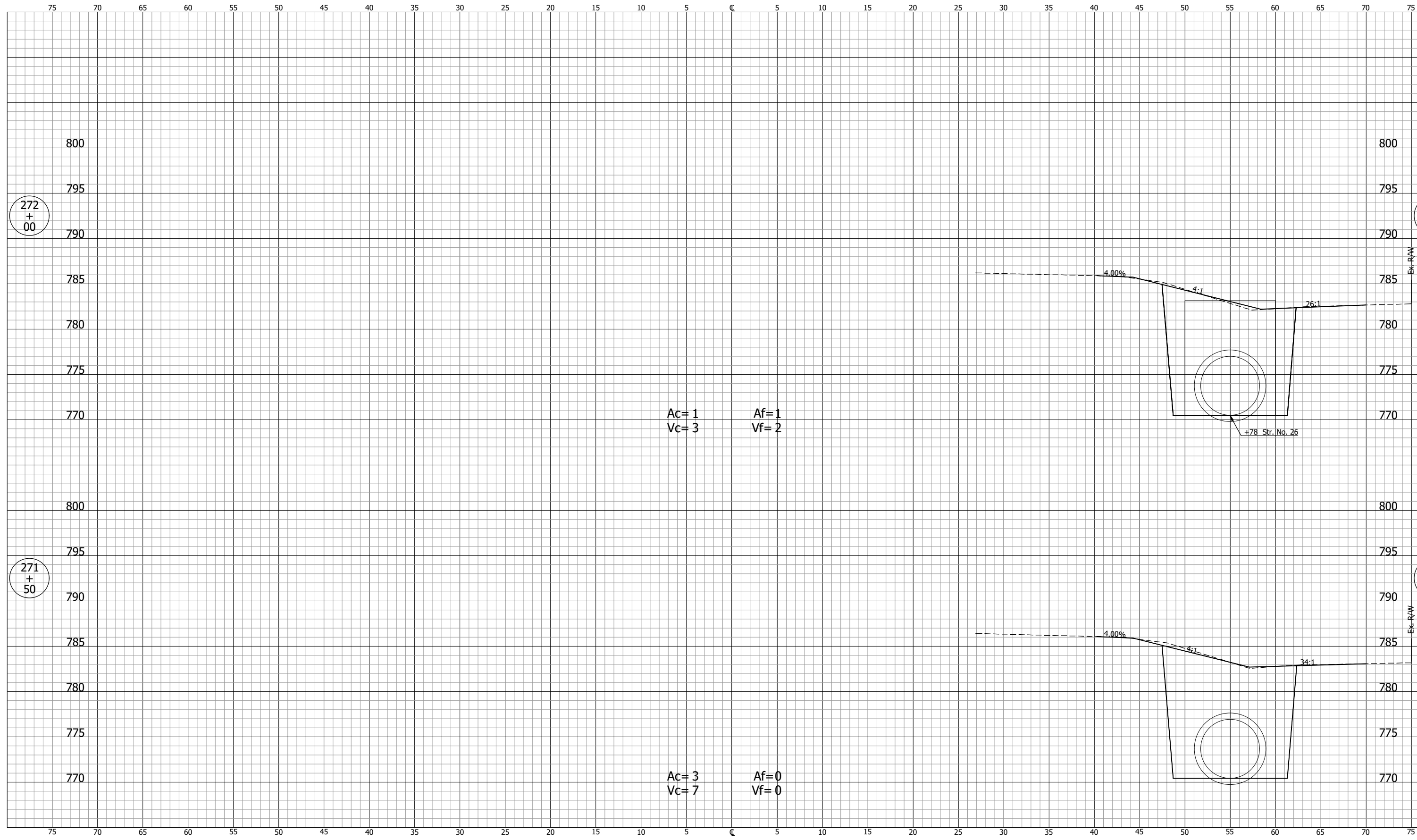

Ac= 1
Vc= 3

Af= 1
Vf= 2

Ac= 3
Vc= 7

Af= 0
Vf= 0

NOT FOR CONSTRUCTION

INDIANA
DEPARTMENT OF TRANSPORTATION

CROSS SECTIONS
LINE "B-1"

SCALE
1" = 5'

BRIDGE FILE

DESIGNATION
2001885 & 2101797

SURVEY BOOK

SHEETS
255 of 357

CONTRACT
R-43382

PROJECT
2001885

PJV - 2/9/2024 11:52 AM - U:\2021\2021124 indot us35\Cad\Design Files\212443D_CO1.dwg (XS_267_B-1)

CROSS SECTIONS
Scale 1 inch = 5 feet

CUT

FILL

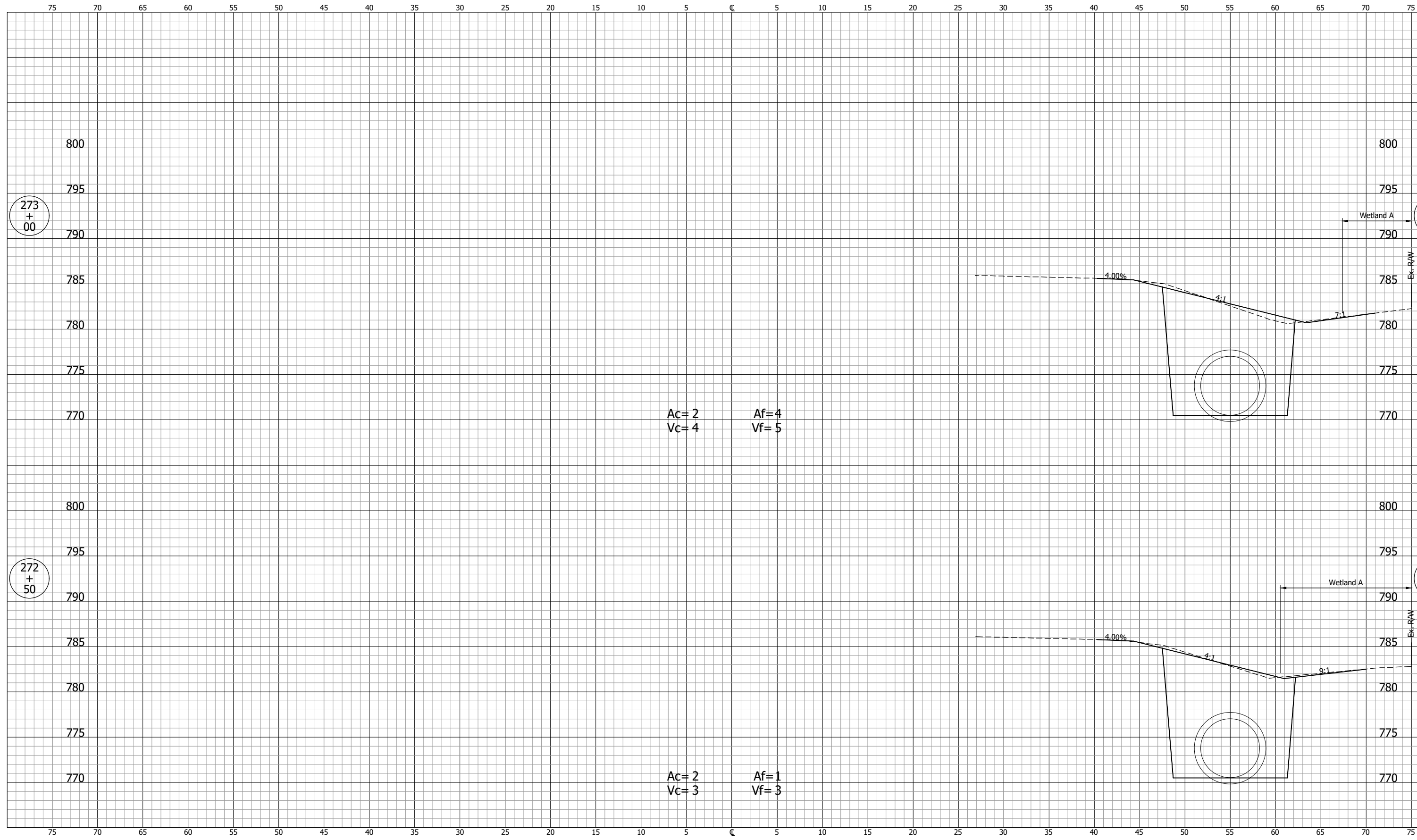

Ac= 2 Af= 4
Vc= 4 Vf= 5

Ac= 2 Af= 1
Vc= 3 Vf= 3

NOT FOR CONSTRUCTION		INDIANA DEPARTMENT OF TRANSPORTATION		SCALE 1" = 5'	BRIDGE FILE
		CROSS SECTIONS LINE "B-1"		DESIGNATION 2001885 & 2101797	
SURVEY BOOK	SHEETS 256 of 357				
CONTRACT R-43382	PROJECT 2001885				

CROSS SECTIONS
Scale 1 inch = 5 feet

CUT

FILL

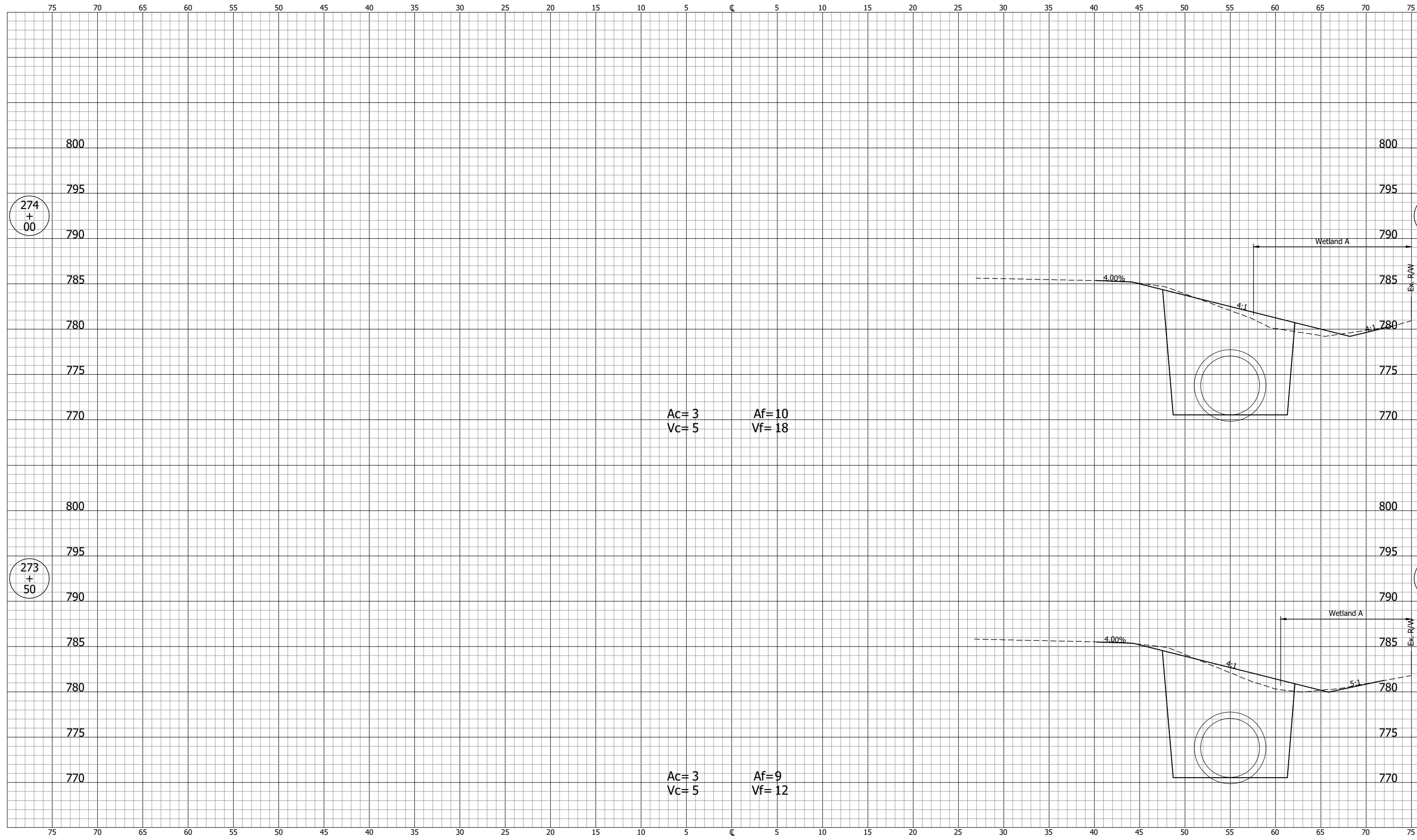

Ac= 3 Af= 10
Vc= 5 Vf= 18

Ac= 3 Af= 9
Vc= 5 Vf= 12

NOT FOR CONSTRUCTION		INDIANA DEPARTMENT OF TRANSPORTATION		SCALE 1" = 5'	BRIDGE FILE
		CROSS SECTIONS LINE "B-1"		DESIGNATION 2001885 & 2101797	
SURVEY BOOK	SHEETS 257 of 357				
CONTRACT R-43382	PROJECT 2001885				

PJV - 2/9/2024 11:52 AM - U:\2021\2021124 indot us35\Cad\C3D\Design Files\212443D_CO1.dwg (XS_268_B=1)

CROSS SECTIONS
Scale 1 inch = 5 feet

CUT

FILL

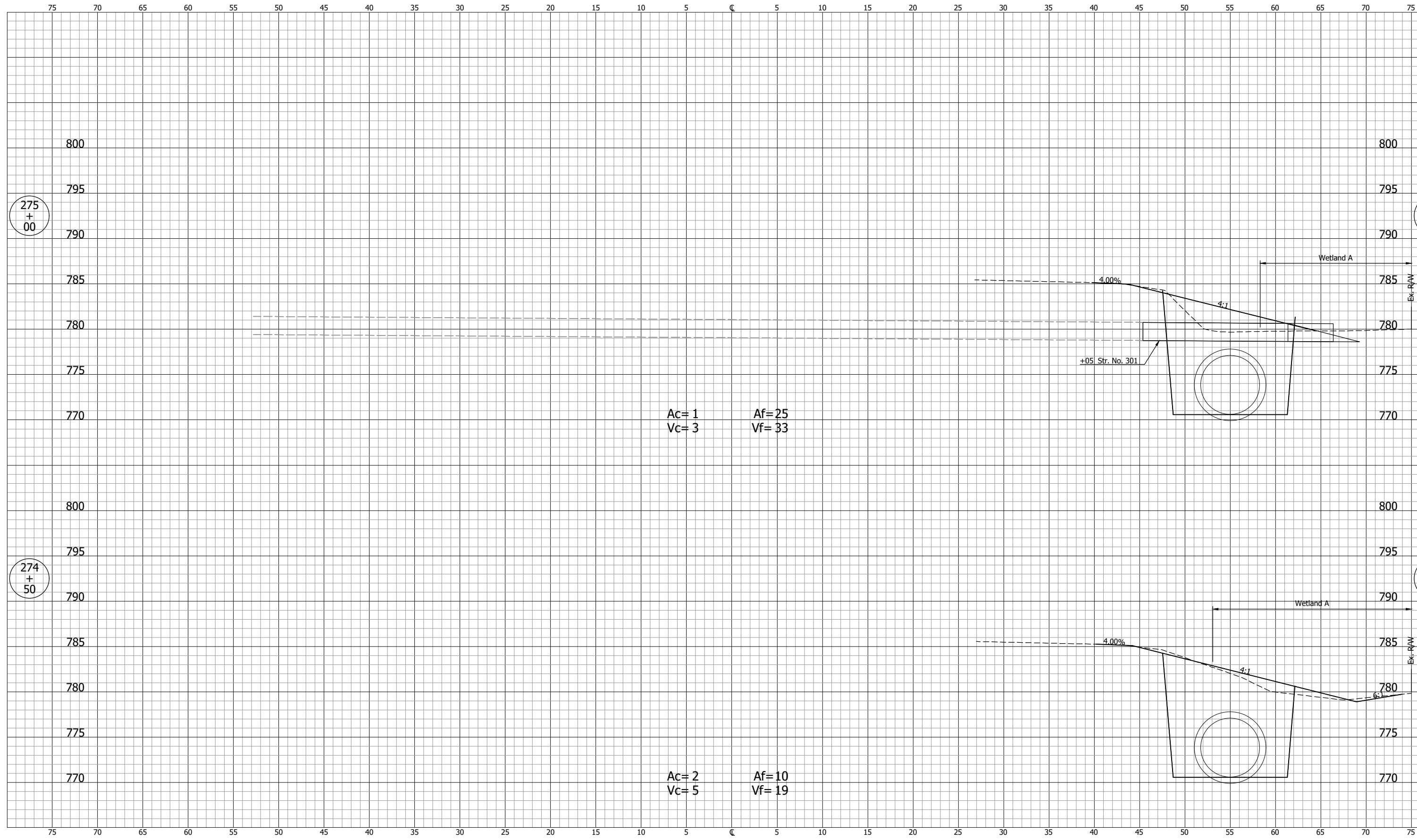

PJV - 2/9/2024 11:52 AM - U:\2021\2021124 indot us35\Cad\C3D\Design Files\212443D_CO1.dwg (XS_269_B-1)

NOT FOR CONSTRUCTION		INDIANA DEPARTMENT OF TRANSPORTATION		SCALE	BRIDGE FILE
				1" = 5'	
DESIGNED: DGA		DRAWN: GDH		DESIGNATION	
CHECKED: DGD		CHECKED: DGA		2001885 & 2101797	
CROSS SECTIONS LINE "B-1"				SURVEY BOOK	SHEETS
					258 of 357
				CONTRACT	PROJECT
				R-43382	2001885

PJV - 2/9/2024 11:52 AM - U:\2021\2021124 indot us35\Cad\C3D\Design Files\212443D_CO1.dwg (XS_270_B=1)

CROSS SECTIONS
Scale 1 inch = 5 feet

CUT

FILL

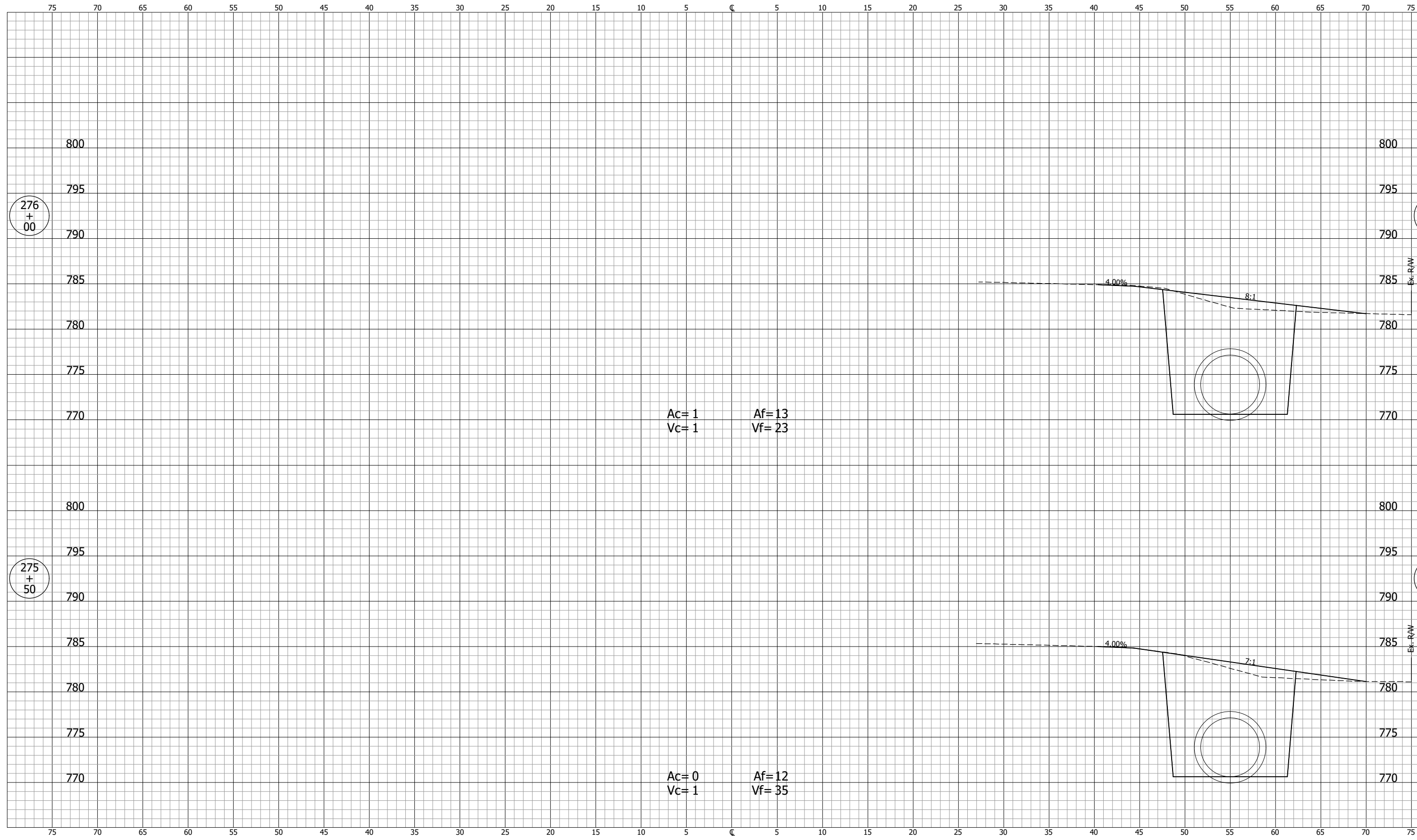

Ac=1 Vf=1 Af=13 Vf=23

Ac=0 Vf=1 Af=12 Vf=35

NOT FOR CONSTRUCTION		INDIANA DEPARTMENT OF TRANSPORTATION		SCALE 1" = 5'	BRIDGE FILE
		CROSS SECTIONS LINE "B-1"		DESIGNATION 2001885 & 2101797	
SURVEY BOOK	SHEETS				
CONTRACT R-43382	259 of 357 PROJECT 2001885				

PJV - 2/9/2024 11:52 AM - U:\2021\202124 indot us35\Cad\C3D\Design Files\212443D_CO1.dwg (XS_271_B=1)

CROSS SECTIONS
Scale 1 inch = 5 feet

CUT

FILL

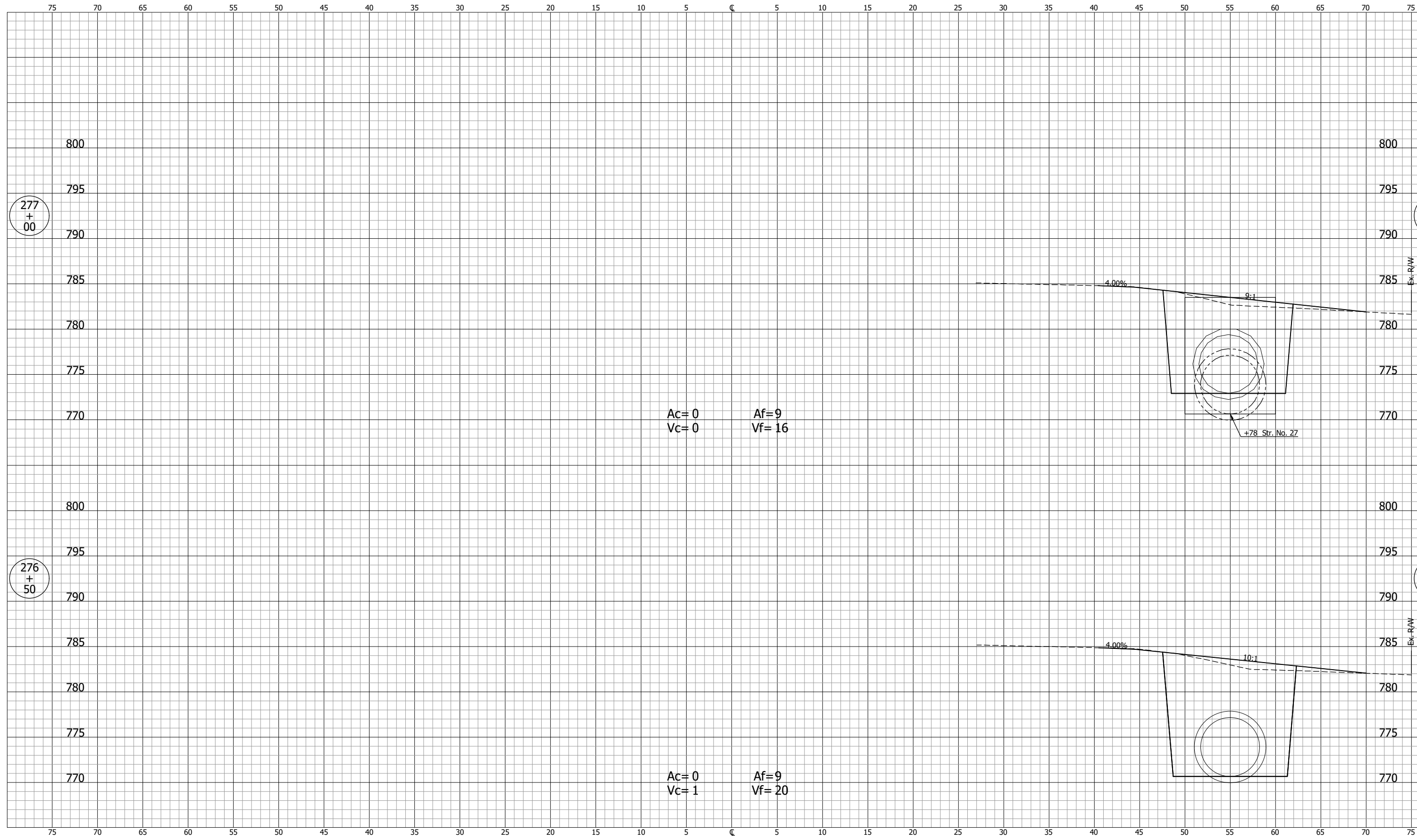

NOT FOR CONSTRUCTION

DESIGNED: DGA	DRAWN: GDH
CHECKED: DGD	CHECKED: DGA

INDIANA
DEPARTMENT OF TRANSPORTATION

**CROSS SECTIONS
LINE "B-1"**

SCALE 1" = 5'	BRIDGE FILE
	DESIGNATION 2001885 & 2101797
SURVEY BOOK	SHEETS 260 of 357
CONTRACT R-43382	PROJECT 2001885

PJV - 2/9/2024 11:52 AM - U:\2021\2021124 indot us35\Cad\C3D\Design Files\212443D_CO1.dwg (XS_272_B=1)

CROSS SECTIONS
Scale 1 inch = 5 feet

CUT

FILL

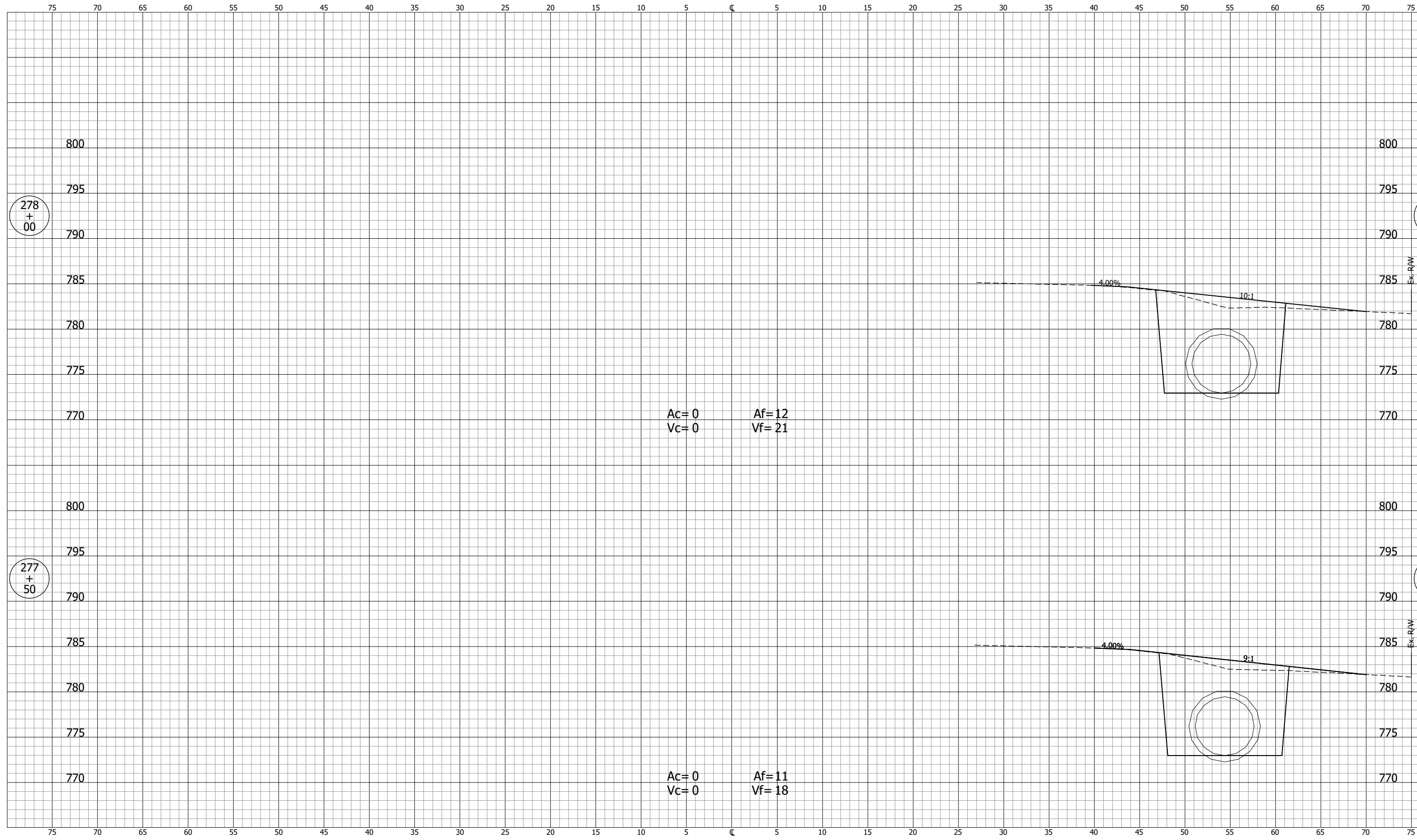

Ac=0 Af=12
Vc=0 Vf=21

Ac=0 Af=11
Vc=0 Vf=18

NOT FOR CONSTRUCTION		INDIANA DEPARTMENT OF TRANSPORTATION		SCALE 1" = 5'	BRIDGE FILE
		CROSS SECTIONS LINE "B-1"		DESIGNATION 2001885 & 2101797	
SURVEY BOOK	SHEETS 261 of 357				
CONTRACT R-43382	PROJECT 2001885				

CROSS SECTIONS
Scale 1 inch = 5 feet

CUT

FILL

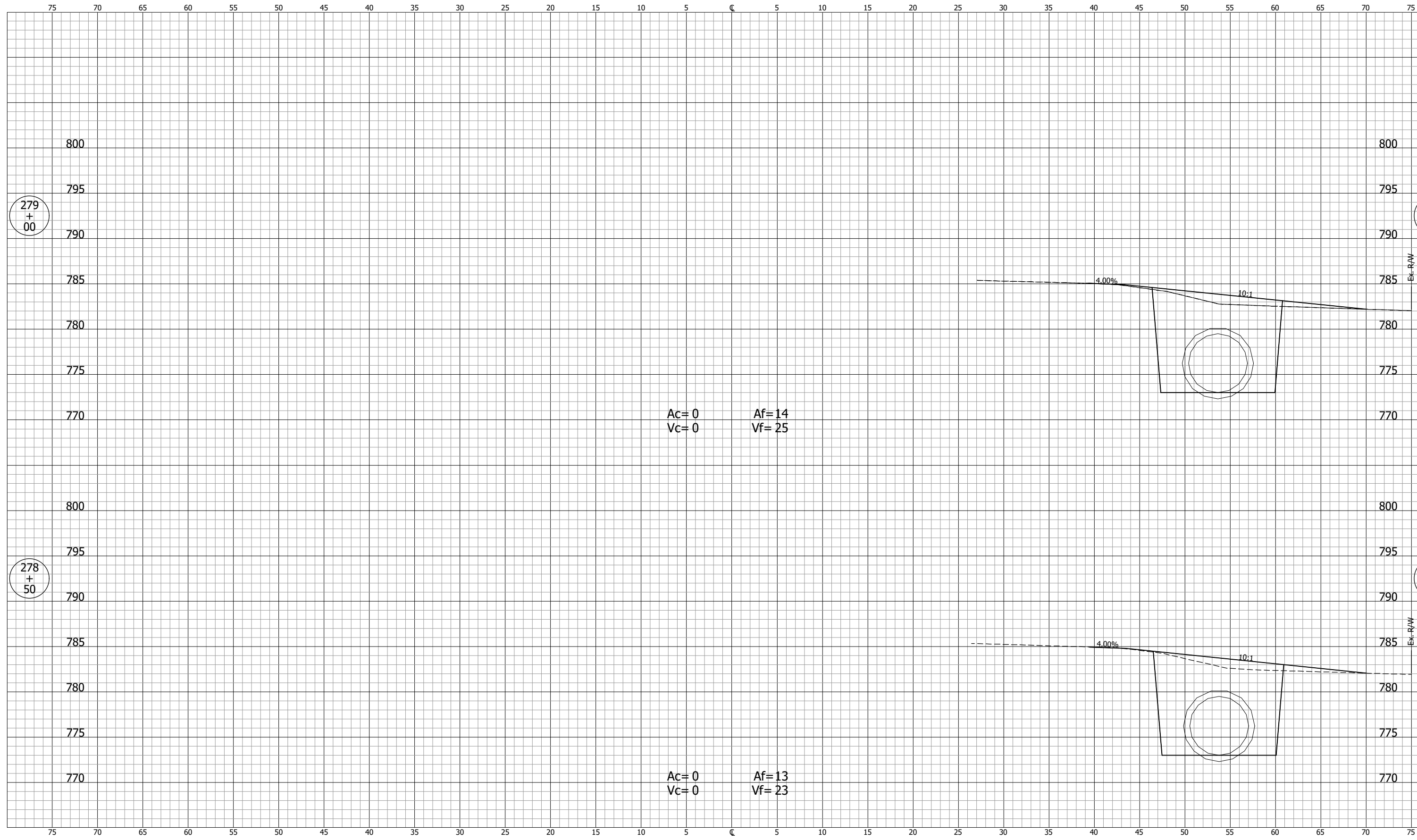

Ac=0 Af=14
Vc=0 Vf=25

Ac=0 Af=13
Vc=0 Vf=23

NOT FOR CONSTRUCTION

INDIANA
DEPARTMENT OF TRANSPORTATION

DESIGNED: DGA DRAWN: GDH
CHECKED: DGD CHECKED: DGA

CROSS SECTIONS
LINE "B-1"

SCALE 1" = 5'	BRIDGE FILE
	DESIGNATION 2001885 & 2101797
SURVEY BOOK	SHEETS 262 of 357
CONTRACT R-43382	PROJECT 2001885

CROSS SECTIONS
Scale 1 inch = 5 feet

CUT

FILL

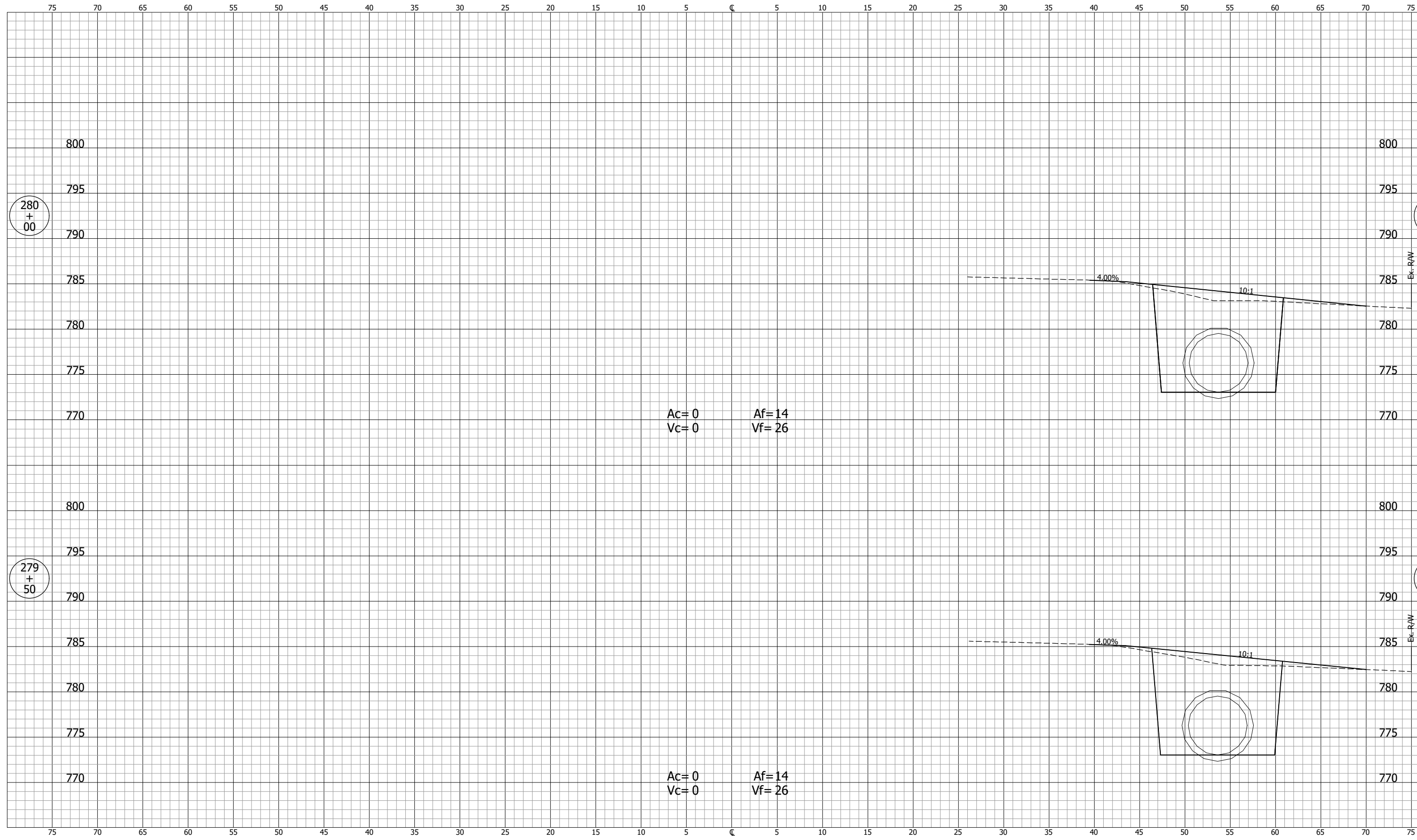

PJV - 2/9/2024 11:52 AM - U:\2021\2021124 indot us35\Cad\Design Files\2124430_CO1.dwg (XS_274_B=1)

NOT FOR CONSTRUCTION		INDIANA DEPARTMENT OF TRANSPORTATION		SCALE	BRIDGE FILE
				1" = 5'	
DESIGNED: DGA DRAWN: GDH		CROSS SECTIONS LINE "B-1"		DESIGNATION	
				2001885 & 2101797	
CHECKED: DGD CHECKED: DGA				SURVEY BOOK	SHEETS
					263 of 357
				CONTRACT	PROJECT
				R-43382	2001885

PJV - 2/9/2024 11:53 AM - U:\2021\202124 indot us35\Cad\Design Files\212443D_CO1.dwg (XS_275_B-1)

CROSS SECTIONS
Scale 1 inch = 5 feet

CUT

FILL

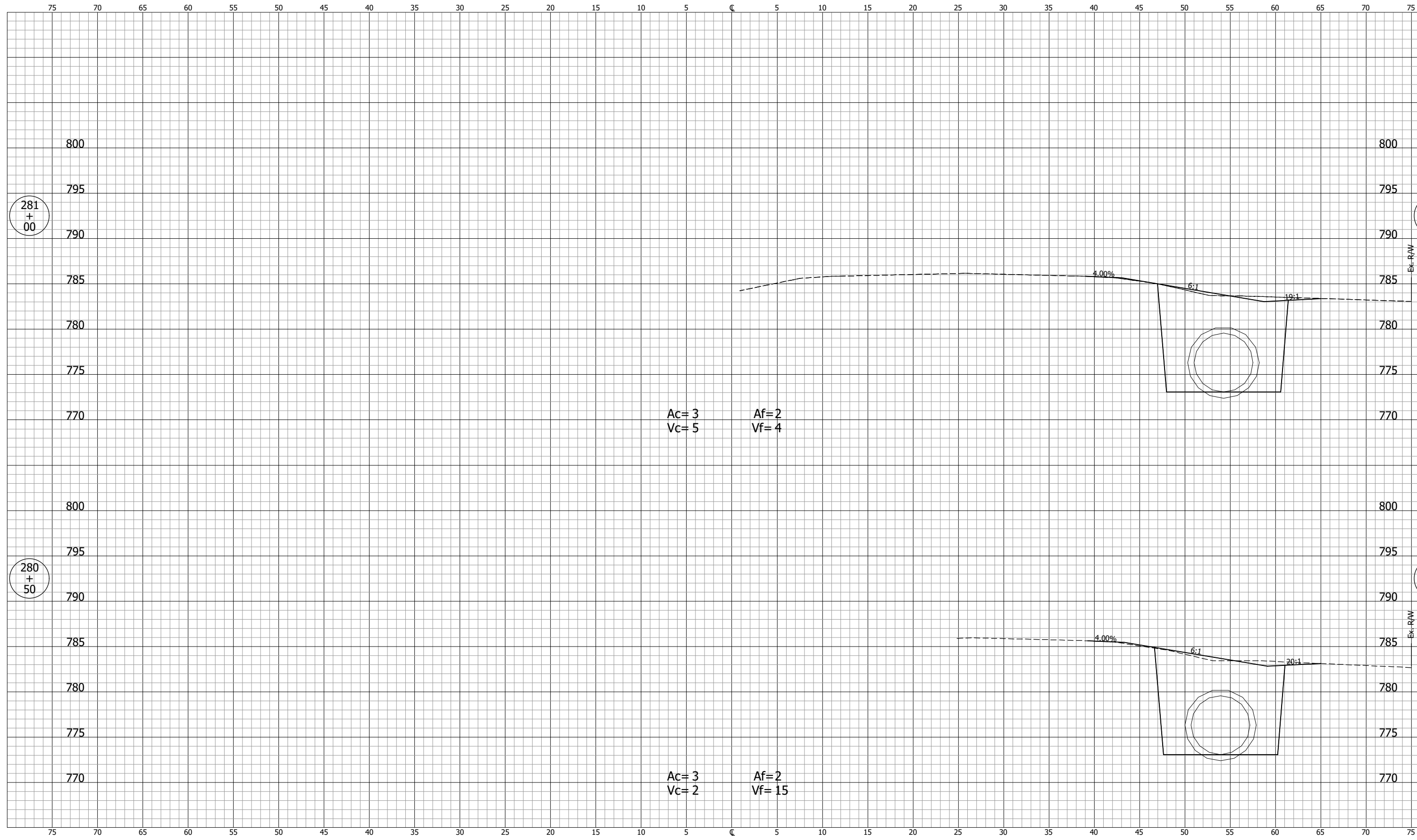

Ac= 3
Vc= 5

Af= 2
Vf= 4

Ac= 3
Vc= 2

Af= 2
Vf= 15

NOT FOR CONSTRUCTION

INDIANA
DEPARTMENT OF TRANSPORTATION

DESIGNED: DGA DRAWN: GDH
CHECKED: DGD CHECKED: DGA

CROSS SECTIONS
LINE "B-1"

SCALE 1" = 5'	BRIDGE FILE
	DESIGNATION 2001885 & 2101797
SURVEY BOOK	SHEETS 264 of 357
CONTRACT R-43382	PROJECT 2001885

PJV - 2/9/2024 11:53 AM - U:\2021\2021124 indot us35\Cad\Design Files\212443D_CO1.dwg (XS_276_B-1)

CROSS SECTIONS
Scale 1 inch = 5 feet

CUT

FILL

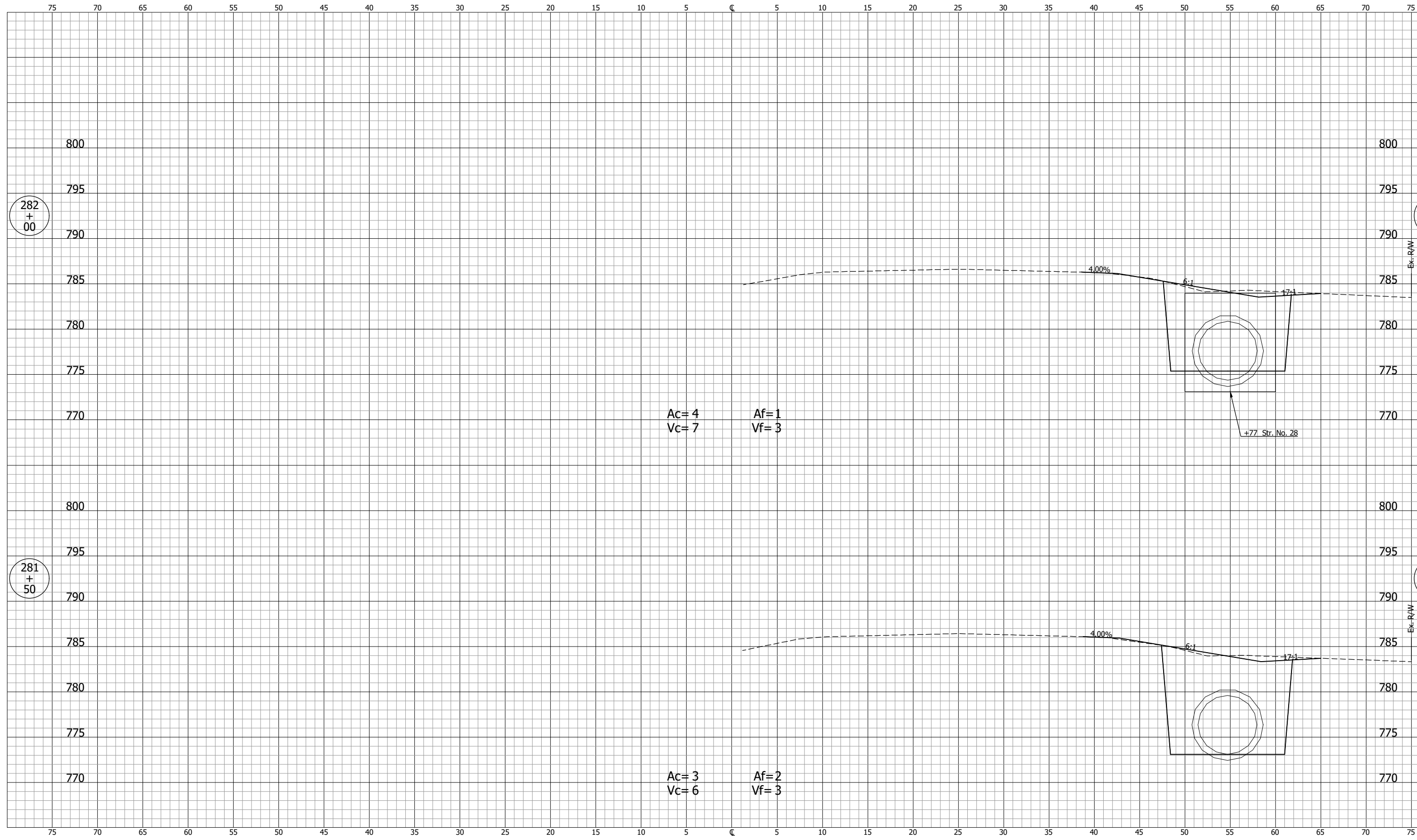

NOT FOR CONSTRUCTION

DESIGNED: DGA DRAWN: GDH
CHECKED: DGD CHECKED: DGA

INDIANA
DEPARTMENT OF TRANSPORTATION

**CROSS SECTIONS
LINE "B-1"**

SCALE 1" = 5'	BRIDGE FILE
	DESIGNATION 2001885 & 2101797
SURVEY BOOK	SHEETS 265 of 357
CONTRACT R-43382	PROJECT 2001885

PJV - 2/9/2024 11:53 AM - U:\2021\2021124 indot us35\Cad\Design Files\212443D_CO1.dwg (XS_277_B-1)

CROSS SECTIONS
Scale 1 inch = 5 feet

CUT

FILL

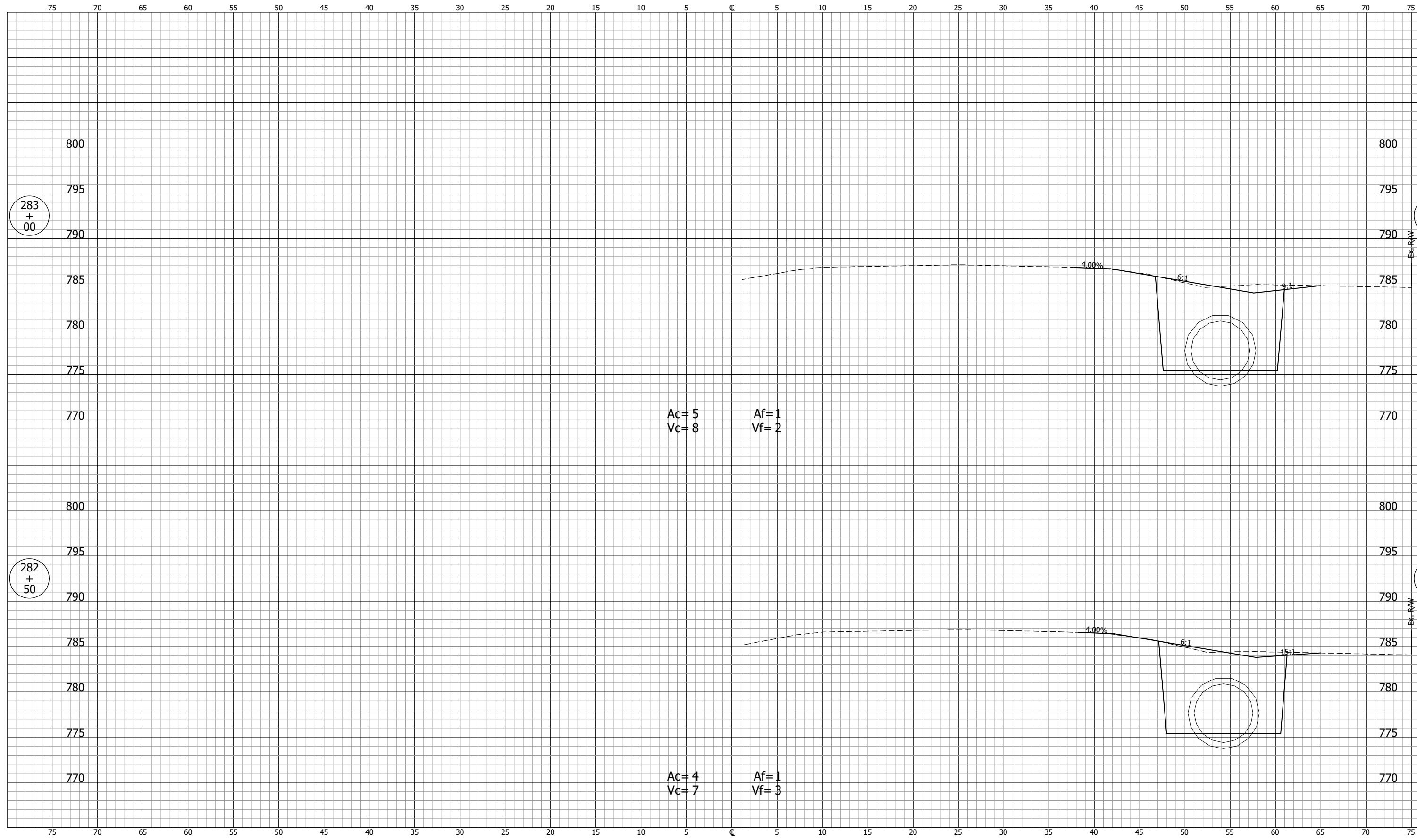

Ac= 5
Vc= 8

Af= 1
Vf= 2

Ac= 4
Vc= 7

Af= 1
Vf= 3

NOT FOR CONSTRUCTION

DESIGNED: DGA	DRAWN: GDH
CHECKED: DGD	CHECKED: DGA

INDIANA
DEPARTMENT OF TRANSPORTATION

**CROSS SECTIONS
LINE "B-1"**

SCALE 1" = 5'	BRIDGE FILE
	DESIGNATION 2001885 & 2101797
SURVEY BOOK	SHEETS 266 of 357
CONTRACT R-43382	PROJECT 2001885

PJV - 2/9/2024 11:53 AM - U:\2021\202124 indot us35\Cad\C3D\Design Files\2124430_CO1.dwg (XS_278_B-1)

CROSS SECTIONS
Scale 1 inch = 5 feet

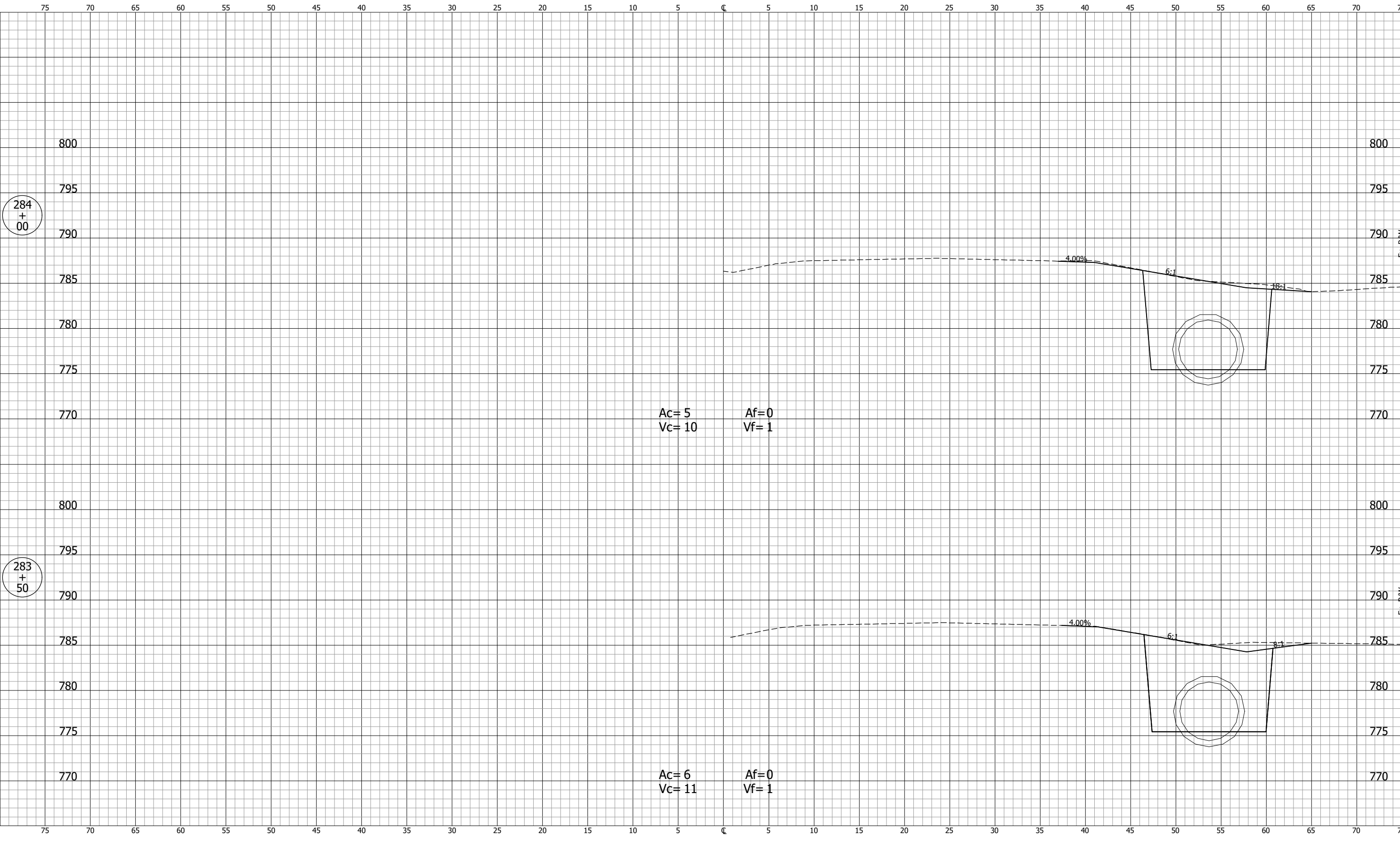

NOT FOR CONSTRUCTION		INDIANA DEPARTMENT OF TRANSPORTATION		SCALE 1" = 5'	BRIDGE FILE
		CROSS SECTIONS LINE "B-1"		DESIGNATION 2001885 & 2101797	
SURVEY BOOK	SHEETS				
CONTRACT R-43382	267			of	357
DESIGNED: DGA	DRAWN: GDH			PROJECT 2001885	
CHECKED: DGD	CHECKED: DGA				

PJV - 2/9/2024 11:53 AM - U:\2021\202124 indot us35\Cad\Design Files\2124430_CO1.dwg (XS_279_B=1)

CROSS SECTIONS
Scale 1 inch = 5 feet

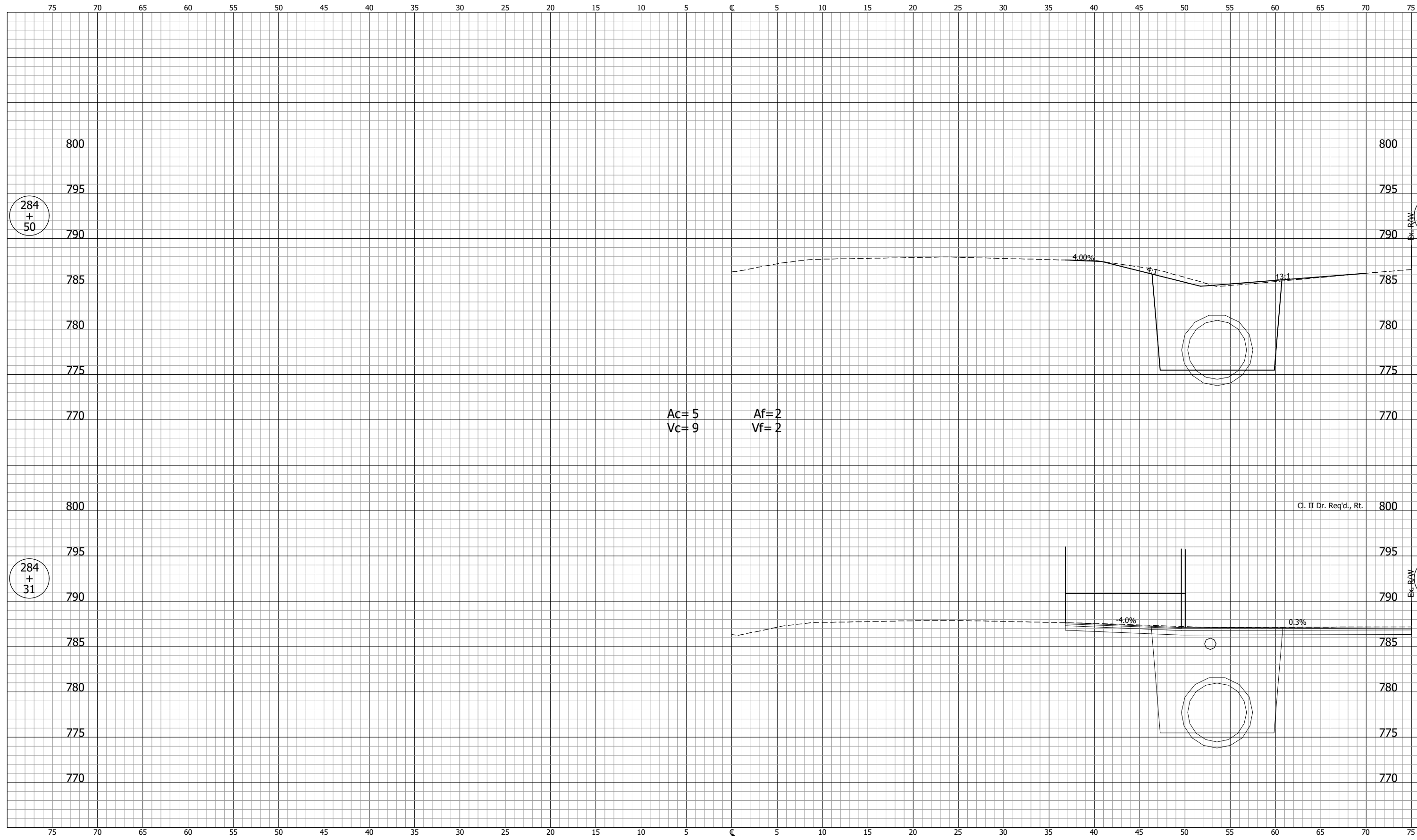

Ac=5 Af=2
Vc=9 Vf=2

Cl. II Dr. Req'd., Rt.

NOT FOR CONSTRUCTION		INDIANA DEPARTMENT OF TRANSPORTATION		SCALE	BRIDGE FILE
				1" = 5'	
DESIGNED: DGA	DRAWN: GDH	CROSS SECTIONS LINE "B-1"			DESIGNATION
CHECKED: DGD	CHECKED: DGA				2001885 & 2101797
				SURVEY BOOK	SHEETS
		CONTRACT	268 of 357		
		R-43382	PROJECT		
			2001885		

PJV - 2/9/2024 11:53 AM - U:\2021\2021124 indot us35\Cad\C3D\Design Files\2124430_CO1.dwg (XS_280_B=1)

CROSS SECTIONS
Scale 1 inch = 5 feet

CUT

FILL

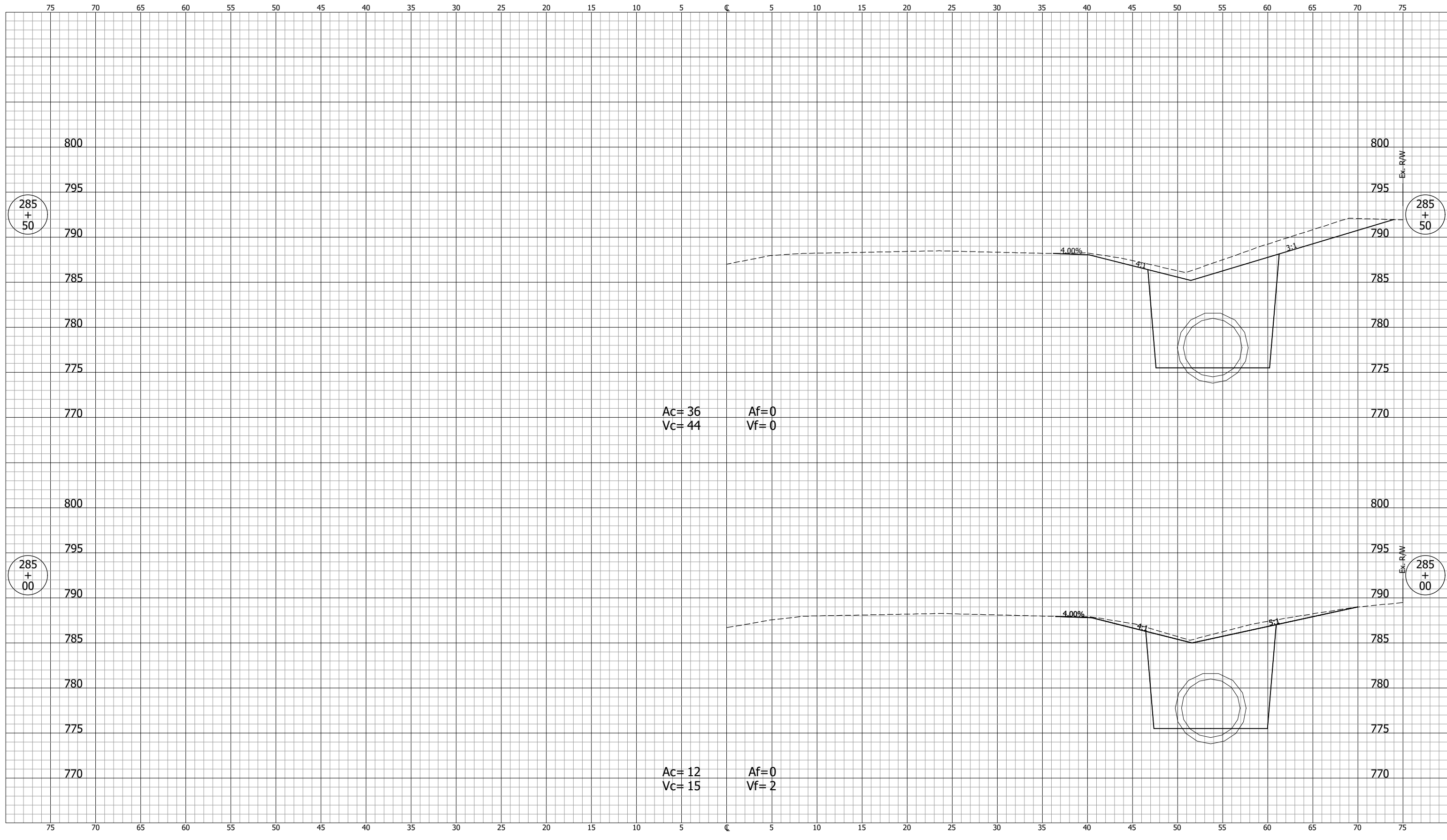

Ac= 36
Vc= 44

Af= 0
Vf= 0

Ac= 12
Vc= 15

Af= 0
Vf= 2

NOT FOR CONSTRUCTION

DESIGNED: DGA	DRAWN: GDH
CHECKED: DGD	CHECKED: DGA

INDIANA
DEPARTMENT OF TRANSPORTATION

**CROSS SECTIONS
LINE "B-1"**

SCALE 1" = 5'	BRIDGE FILE
	DESIGNATION 2001885 & 2101797
SURVEY BOOK	SHEETS 269 of 357
CONTRACT R-43382	PROJECT 2001885

PJV - 2/9/2024 11:53 AM - U:\2021\202124 indot us35\Cad\C3D\Design Files\2124430_CO1.dwg (XS_281_B=1)

CROSS SECTIONS
Scale 1 inch = 5 feet

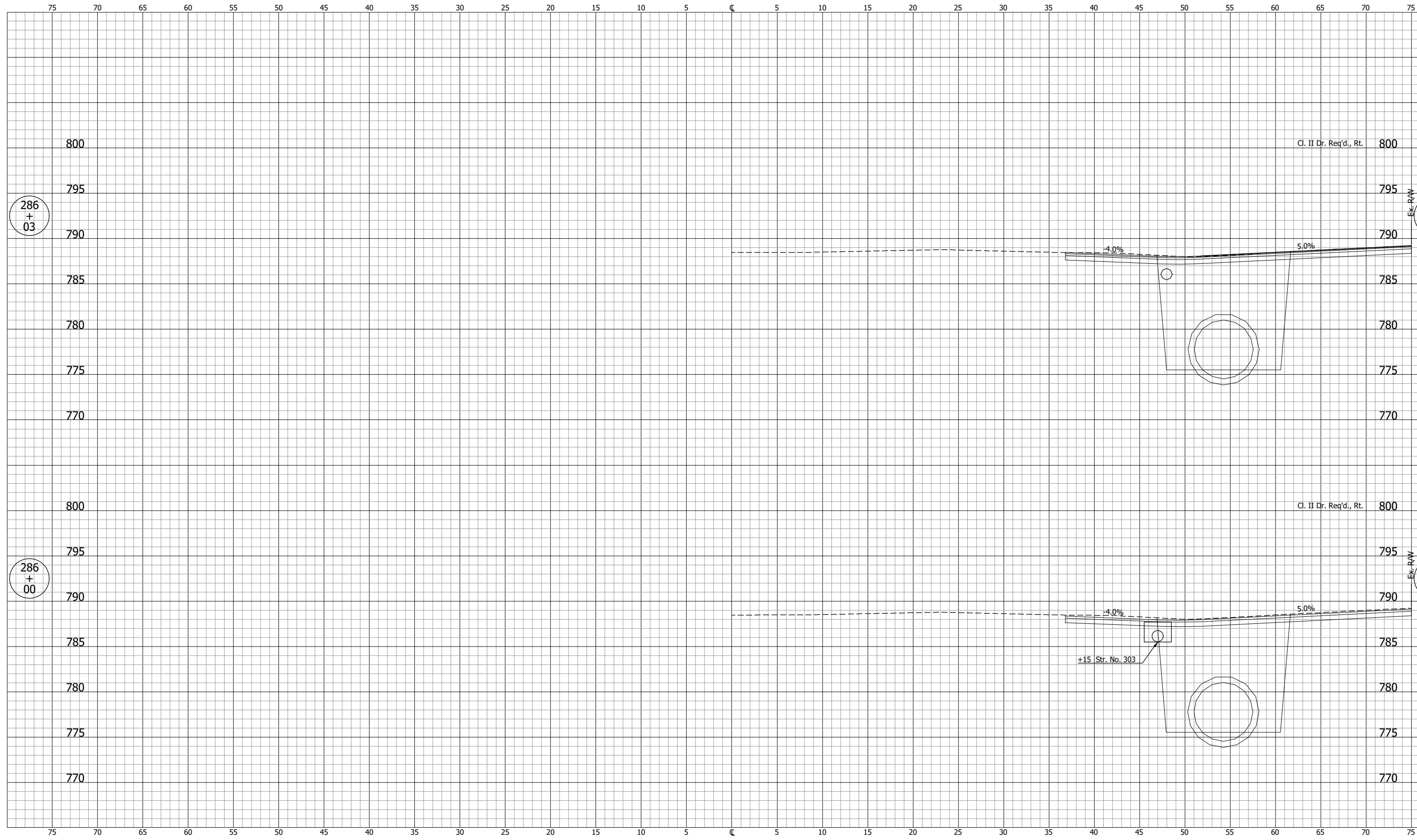

NOT FOR CONSTRUCTION

DESIGNED: DGA	DRAWN: GDH
CHECKED: DGD	CHECKED: DGA

INDIANA
DEPARTMENT OF TRANSPORTATION

**CROSS SECTIONS
LINE "B-1"**

SCALE 1" = 5'	BRIDGE FILE
	DESIGNATION 2001885 & 2101797
SURVEY BOOK	SHEETS 270 of 357
CONTRACT R-43382	PROJECT 2001885

PJV - 2/9/2024 11:53 AM - U:\2021\2021124 indot us35\Cad\C3D\Design Files\212443D_CO1.dwg (XS_282_B=1)

CROSS SECTIONS
Scale 1 inch = 5 feet

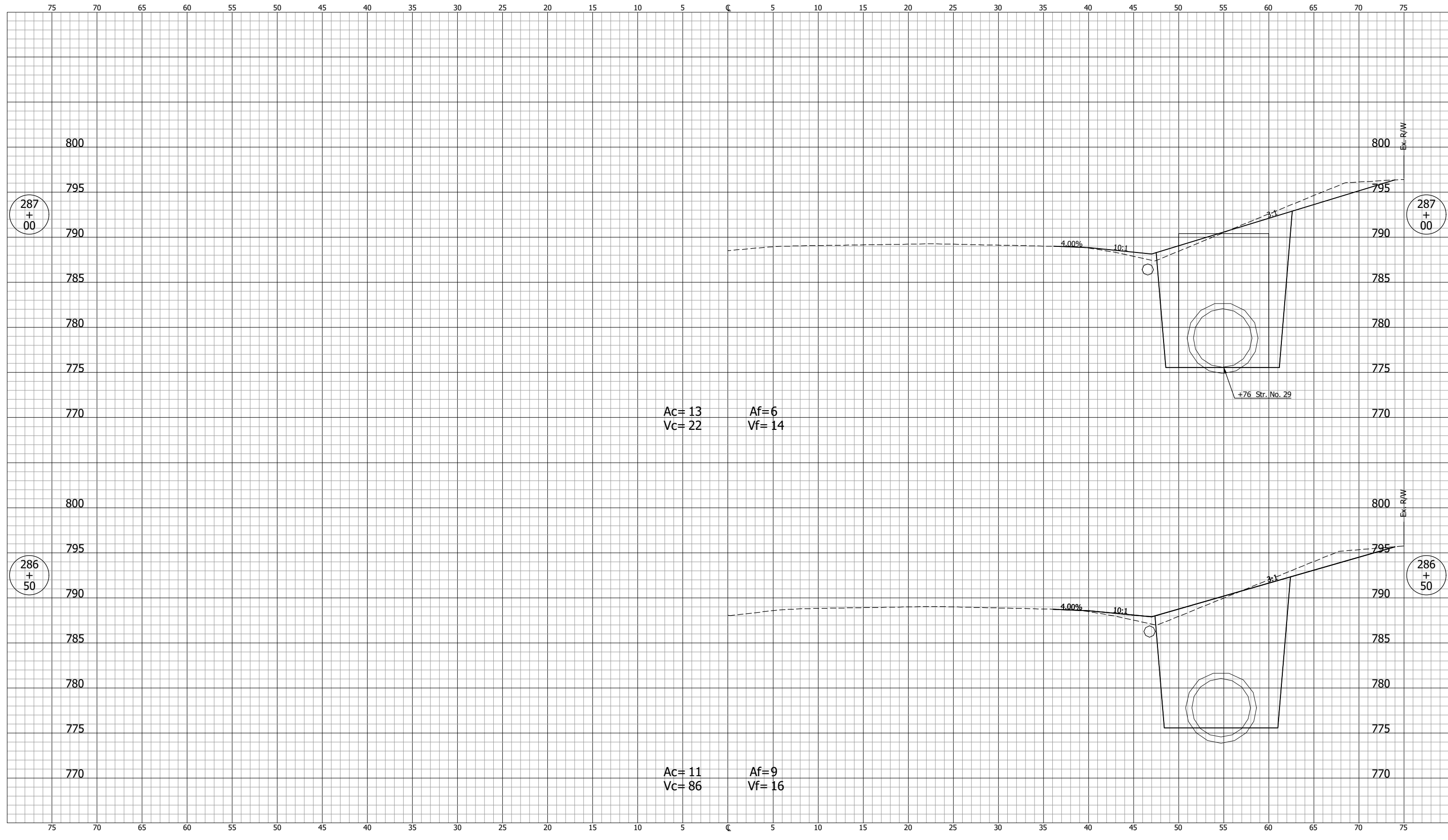

Ac= 13 Af= 6
Vc= 22 Vf= 14

Ac= 11 Af= 9
Vc= 86 Vf= 16

NOT FOR CONSTRUCTION		INDIANA DEPARTMENT OF TRANSPORTATION		SCALE	BRIDGE FILE
				1" = 5'	
DESIGNED: DGA DRAWN: GDH		CROSS SECTIONS LINE "B-1"		DESIGNATION	
				2001885 & 2101797	
CHECKED: DGD CHECKED: DGA				SURVEY BOOK	SHEETS
				R-43382	271 of 357
				PROJECT	2001885

PJV - 2/9/2024 11:53 AM - U:\2021\2021124 indot us35\Cad\Design Files\212443D_CO1.dwg (XS_283_B-1)

CROSS SECTIONS
Scale 1 inch = 5 feet

CUT

FILL

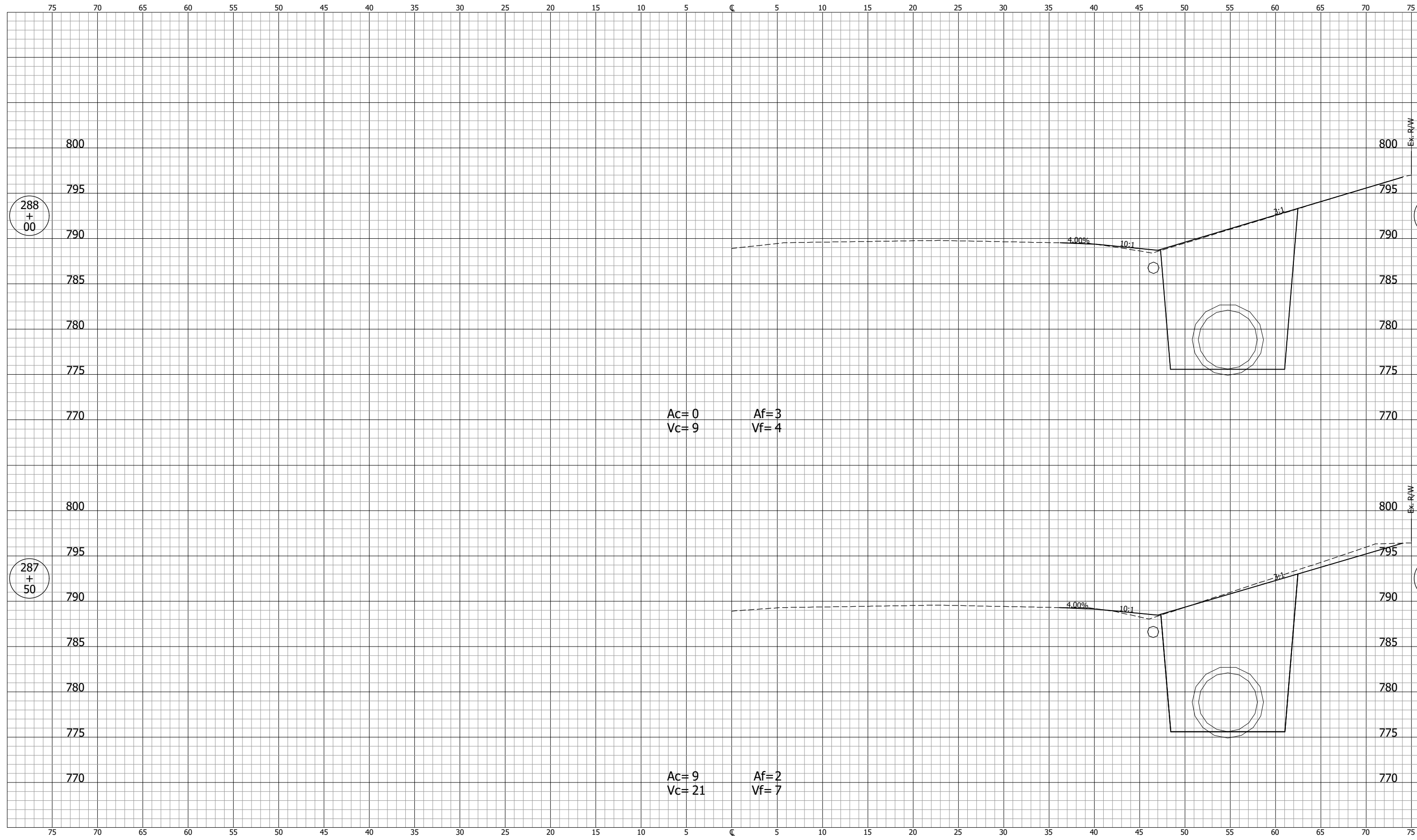

Ac=0 Af=3
Vc=9 Vf=4

Ac=9 Af=2
Vc=21 Vf=7

NOT FOR CONSTRUCTION		INDIANA DEPARTMENT OF TRANSPORTATION		SCALE 1" = 5'	BRIDGE FILE
		CROSS SECTIONS LINE "B-1"		DESIGNATION 2001885 & 2101797	
SURVEY BOOK	SHEETS				
CONTRACT R-43382	272 of 357 PROJECT 2001885				

PJV - 2/9/2024 11:53 AM - U:\2021\202124 indot us35\Cad\Design Files\212443D_CO1.dwg (XS_284_B=1)

CROSS SECTIONS
Scale 1 inch = 5 feet

CUT

FILL

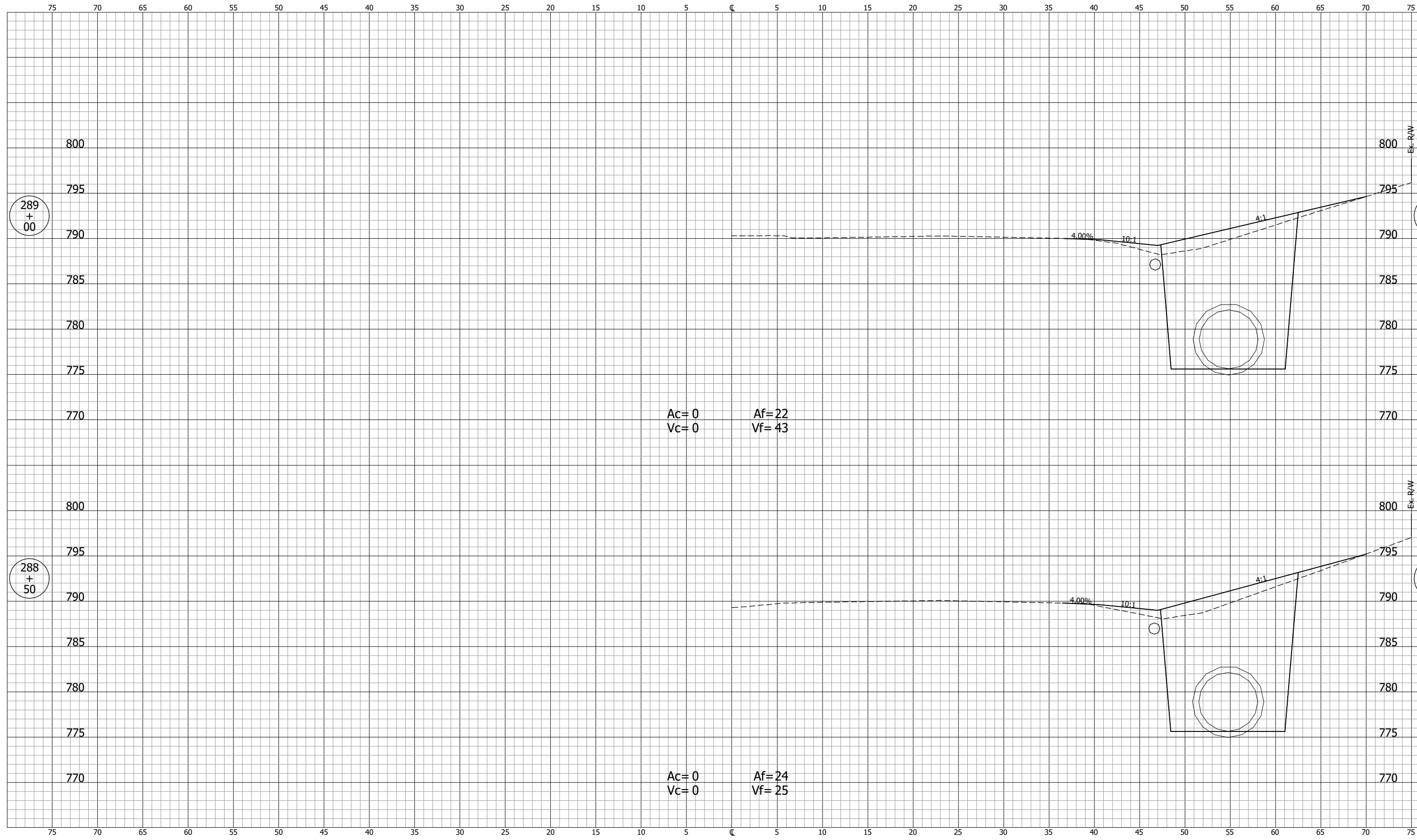

Ac= 0 Af= 22
Vc= 0 Vf= 43

Ac= 0 Af= 24
Vc= 0 Vf= 25

NOT FOR CONSTRUCTION		INDIANA DEPARTMENT OF TRANSPORTATION		SCALE 1" = 5'	BRIDGE FILE
		CROSS SECTIONS LINE "B-1"		DESIGNATION 2001885 & 2101797	
SURVEY BOOK	SHEETS 273 of 357				
CONTRACT R-43382	PROJECT 2001885				

PJV - 2/9/2024 11:53 AM - U:\2021\2021124 indot us35\Cad\C3D\Design Files\2124430_CO1.dwg (XS_285_B-1)

CROSS SECTIONS
Scale 1 inch = 5 feet

CUT

FILL

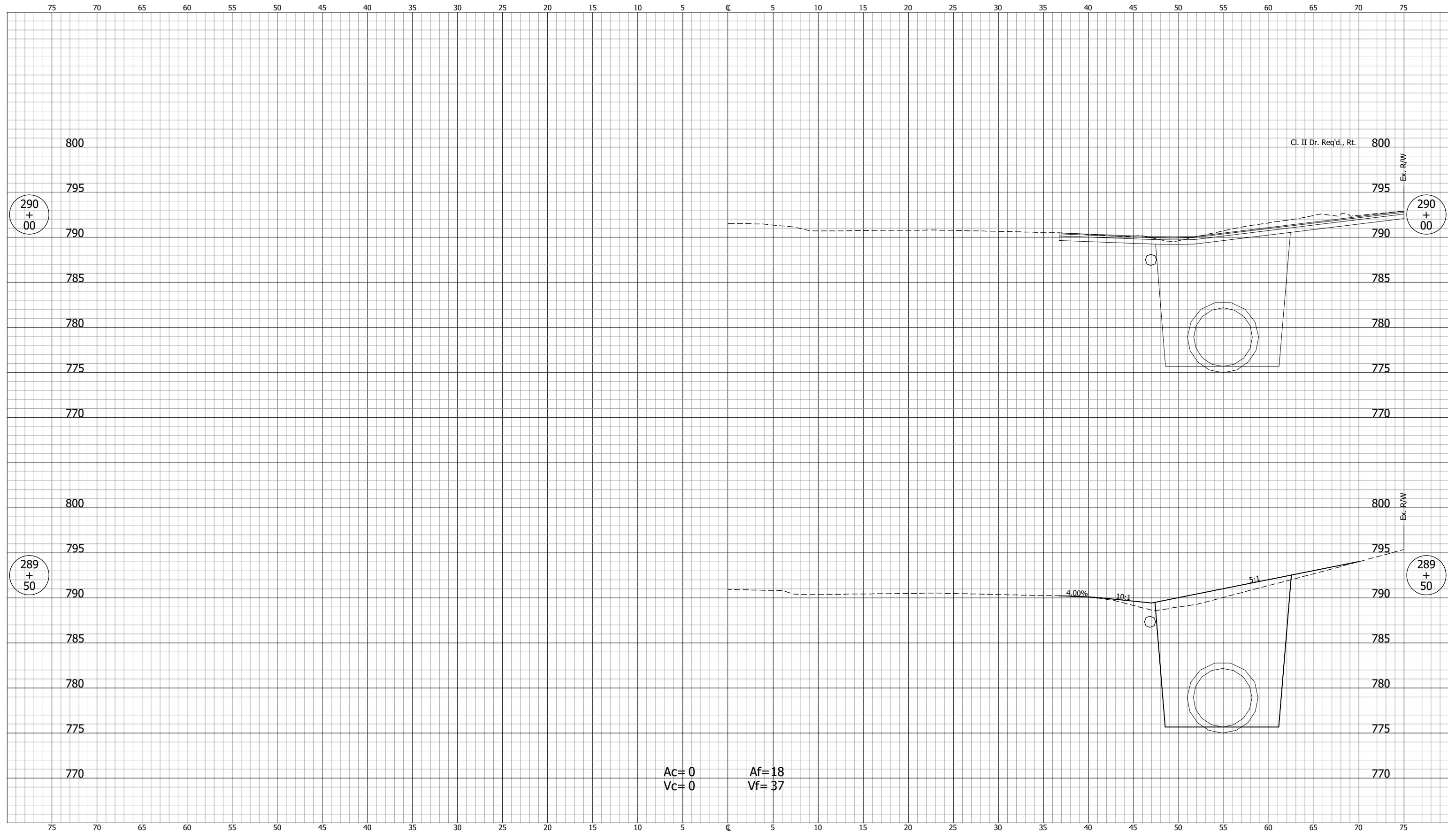

Ac= 0 Af= 18
Vc= 0 Vf= 37

NOT FOR CONSTRUCTION		INDIANA DEPARTMENT OF TRANSPORTATION		SCALE 1" = 5'	BRIDGE FILE
		CROSS SECTIONS LINE "B-1"		DESIGNATION 2001885 & 2101797	
SURVEY BOOK	SHEETS 274 of 357				
CONTRACT R-43382	PROJECT 2001885				

PJV - 2/9/2024 11:53 AM - U:\2021\2021124 indot us35\Cad\Design Files\2124430_CO1.dwg (XS_286_B=1)

CROSS SECTIONS
Scale 1 inch = 5 feet

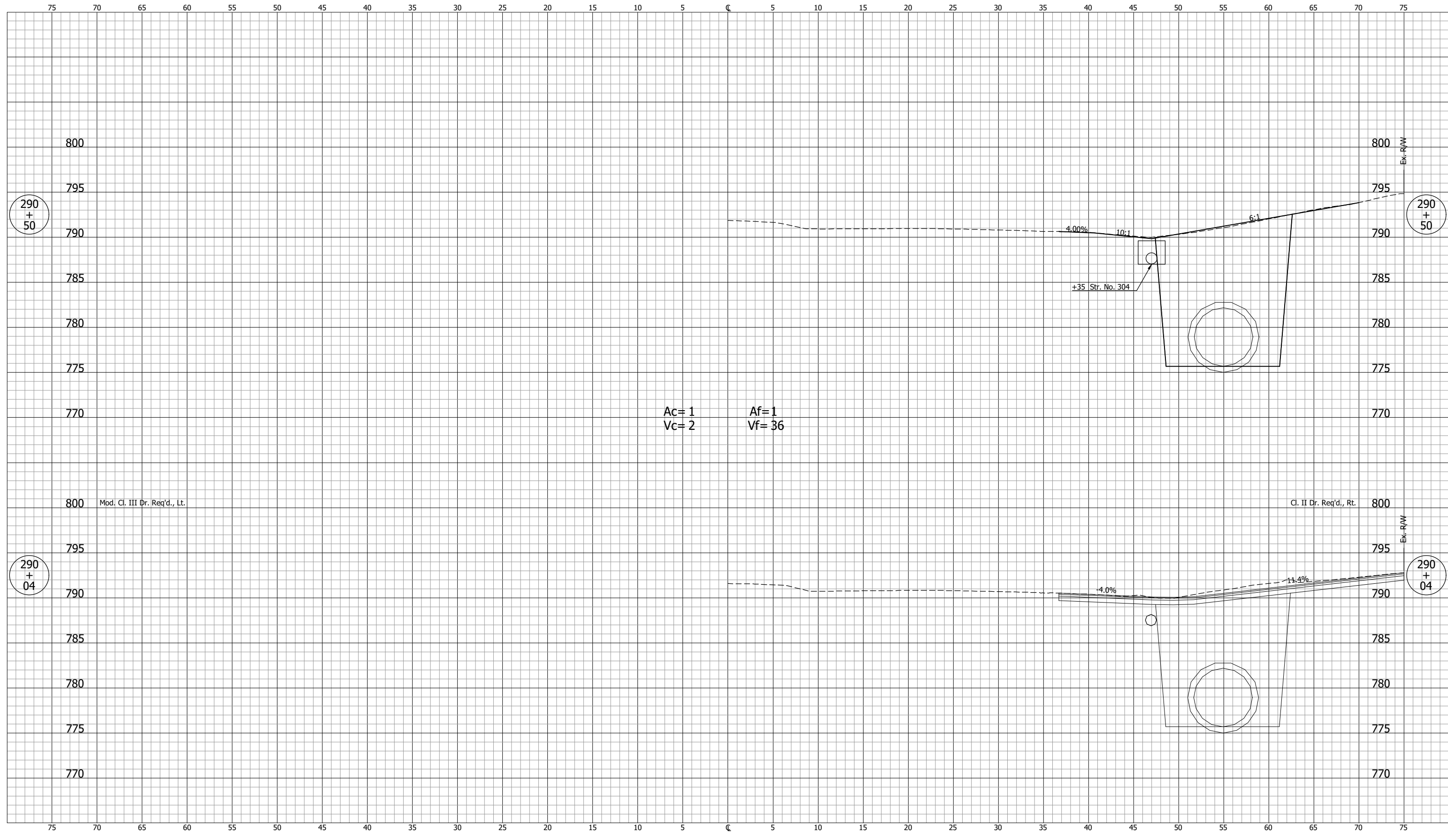

Ac=1 Vf=2 Af=1 Vf=36

Mod. Cl. III Dr. Req'd., Lt.

Cl. II Dr. Req'd., Rt.

NOT FOR CONSTRUCTION		INDIANA DEPARTMENT OF TRANSPORTATION		SCALE 1" = 5'	BRIDGE FILE
		CROSS SECTIONS LINE "B-1"		DESIGNATION 2001885 & 2101797	
SURVEY BOOK	SHEETS 275 of 357				
CONTRACT R-43382	PROJECT 2001885				

DESIGNED: DGA	DRAWN: GDH
CHECKED: DGD	CHECKED: DGA

CROSS SECTIONS
Scale 1 inch = 5 feet

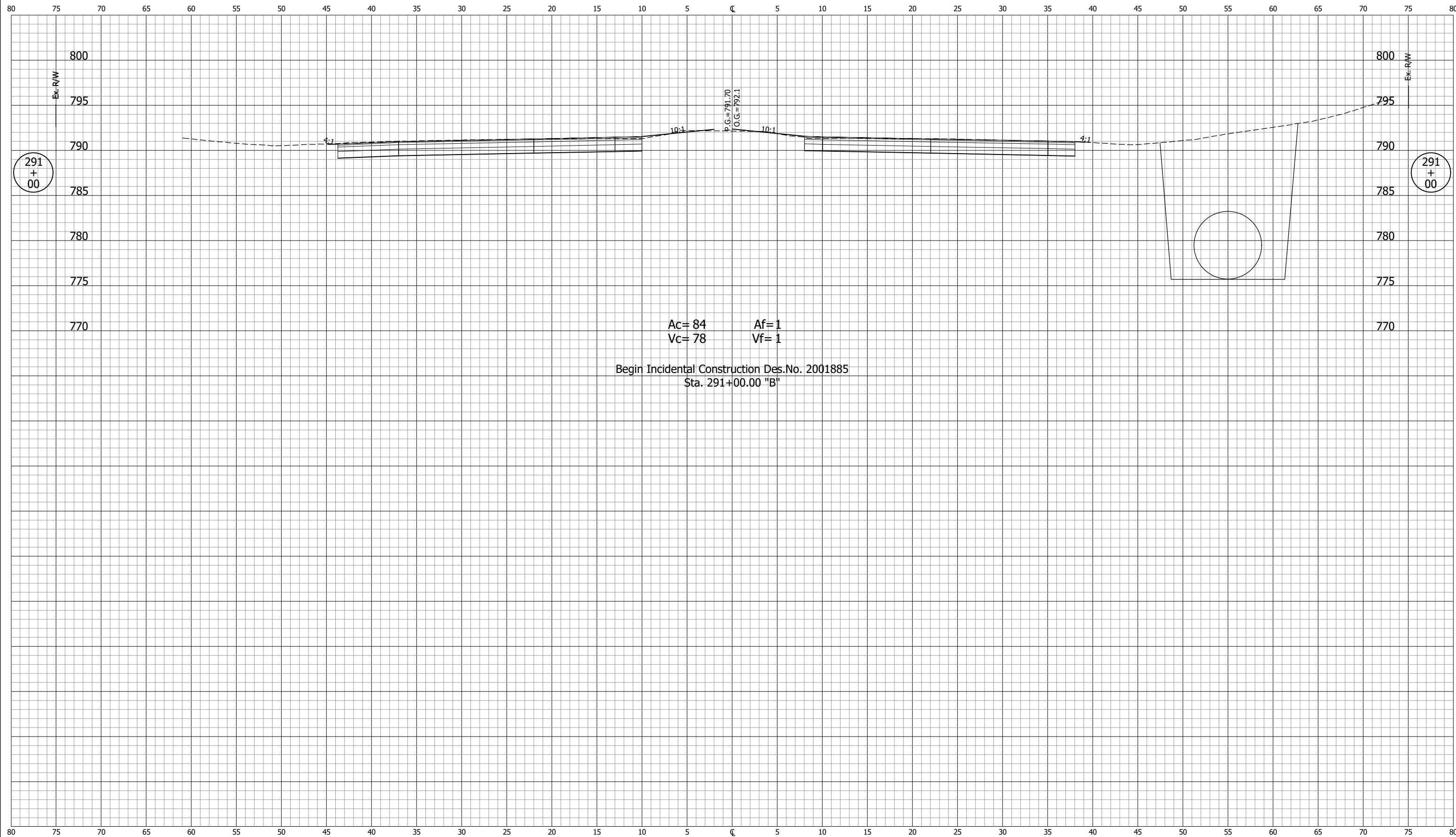

Ac= 84 Af= 1
Vc= 78 Vf= 1

Begin Incidental Construction Des.No. 2001885
Sta. 291+00.00 "B"

GDH - 2/9/2024 12:25 PM - U:\2021\202124 indot us35\Cad\C30\Design Files\212440D_CO1.dwg (XS_1_B)

NOT FOR CONSTRUCTION		INDIANA DEPARTMENT OF TRANSPORTATION		SCALE 1" = 5'	BRIDGE FILE
		CROSS SECTIONS LINE "B"		DESIGNATION 2001885 & 2101797	
SURVEY BOOK	SHEETS 276 of 357				
CONTRACT R-43382	PROJECT 2001885				

GDH - 2/9/2024 12:25 PM - U:\2021\202124.indot.us35\Cad\C30\Design Files\212440D_C01.dwg (XS_2_B)

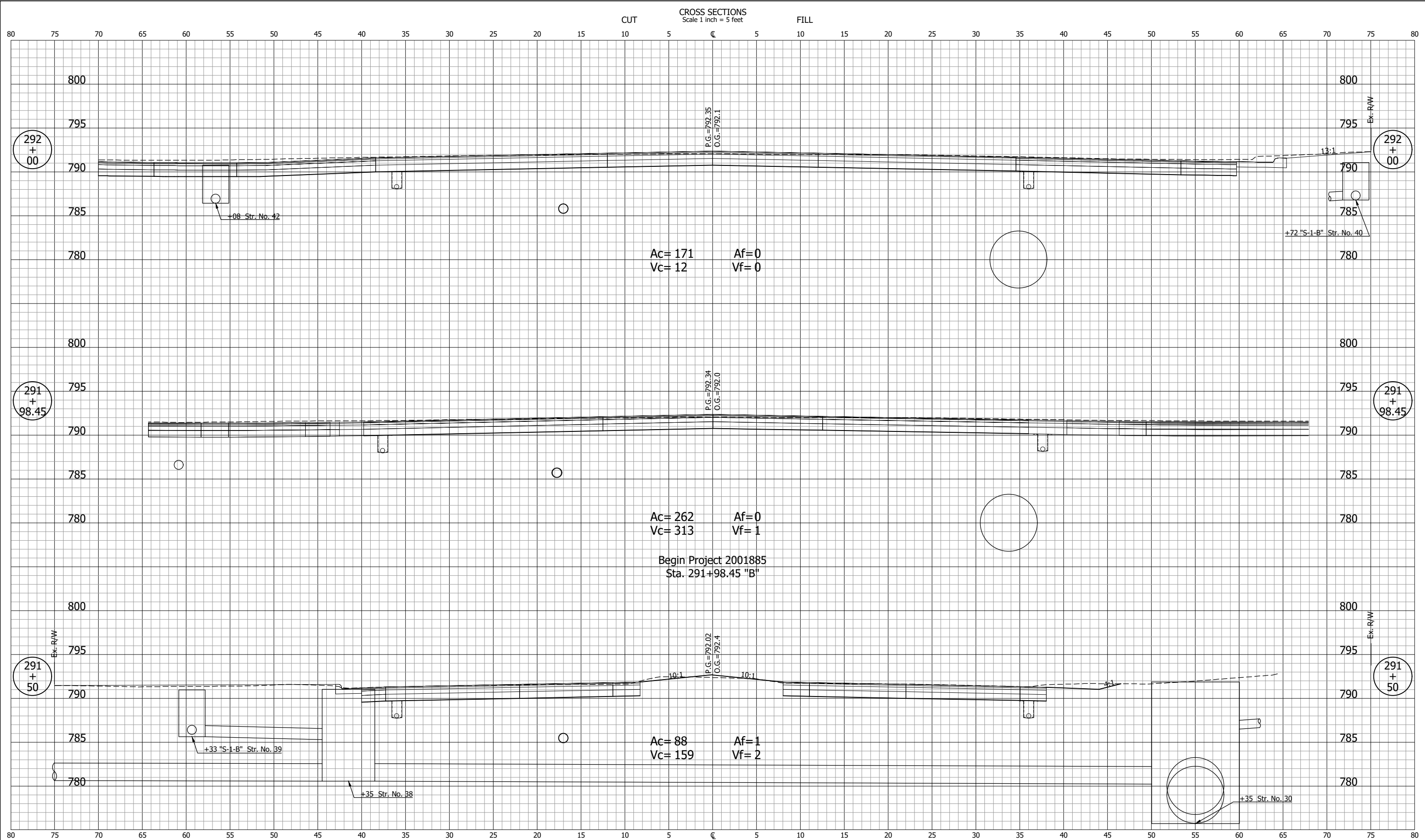

NOT FOR CONSTRUCTION		INDIANA DEPARTMENT OF TRANSPORTATION		SCALE 1" = 5'	BRIDGE FILE
DESIGNED: DGA		DRAWN: GDH		DESIGNATION 2001885 & 2101797	
CHECKED: DGD		CHECKED: DGA		SURVEY BOOK	SHEETS 277 of 357
		CROSS SECTIONS LINE "B"		CONTRACT R-43382	PROJECT 2001885

CROSS SECTIONS
Scale 1 inch = 5 feet

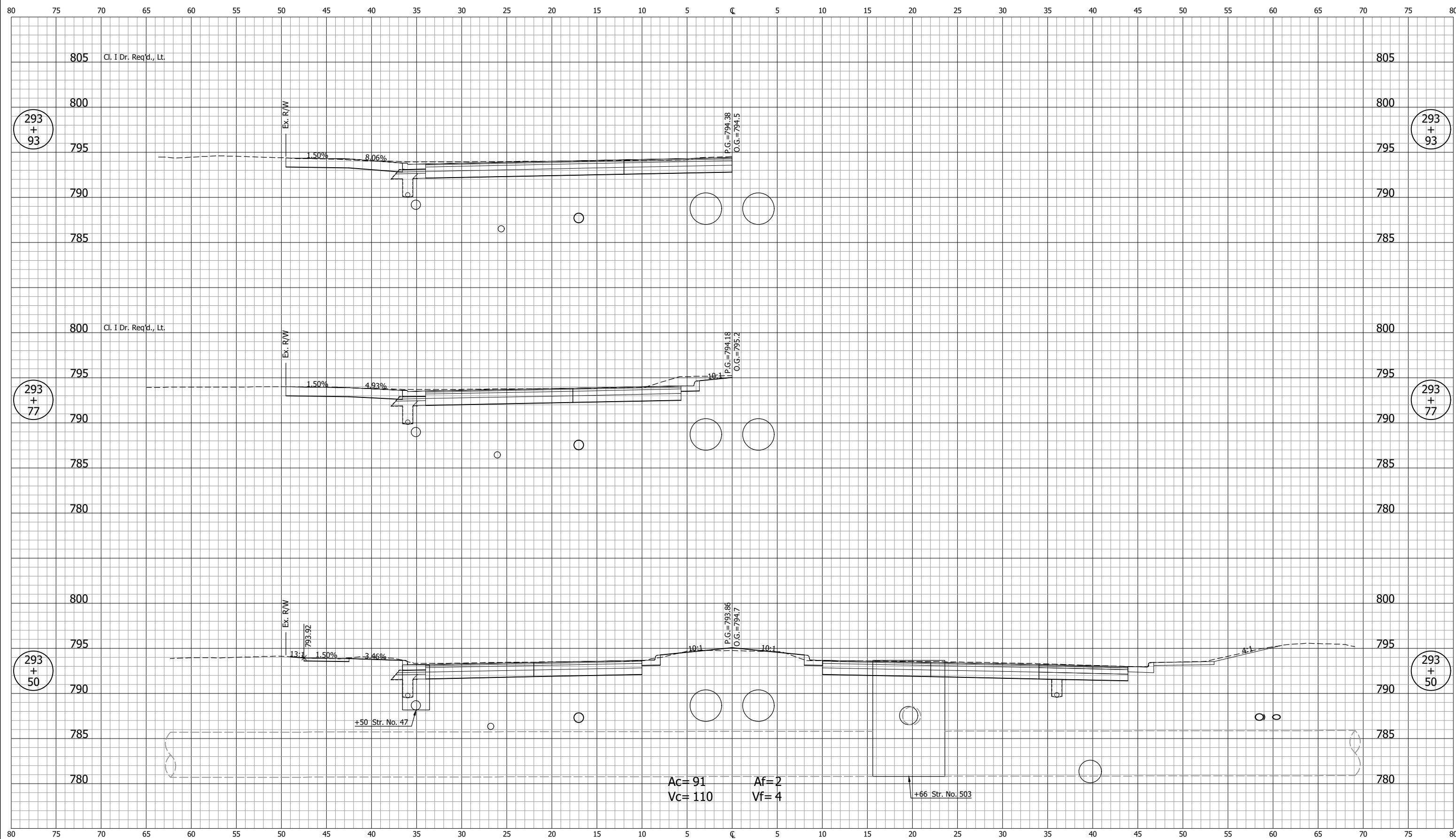

GDH - 2/9/2024 12:25 PM - U:\2021\202124 indot us35\Cad\C30\Design Files\212440D_CO1.dwg (XS_4_B)

NOT FOR CONSTRUCTION		INDIANA DEPARTMENT OF TRANSPORTATION		SCALE 1" = 5'	BRIDGE FILE
DESIGNED: DGA	DRAWN: GDH	CROSS SECTIONS LINE "B"		DESIGNATION 2001885 & 2101797	
CHECKED: DGD	CHECKED: DGA			SURVEY BOOK	SHEETS 279 of 357
				CONTRACT R-43382	PROJECT 2001885

CROSS SECTIONS
Scale 1 inch = 5 feet

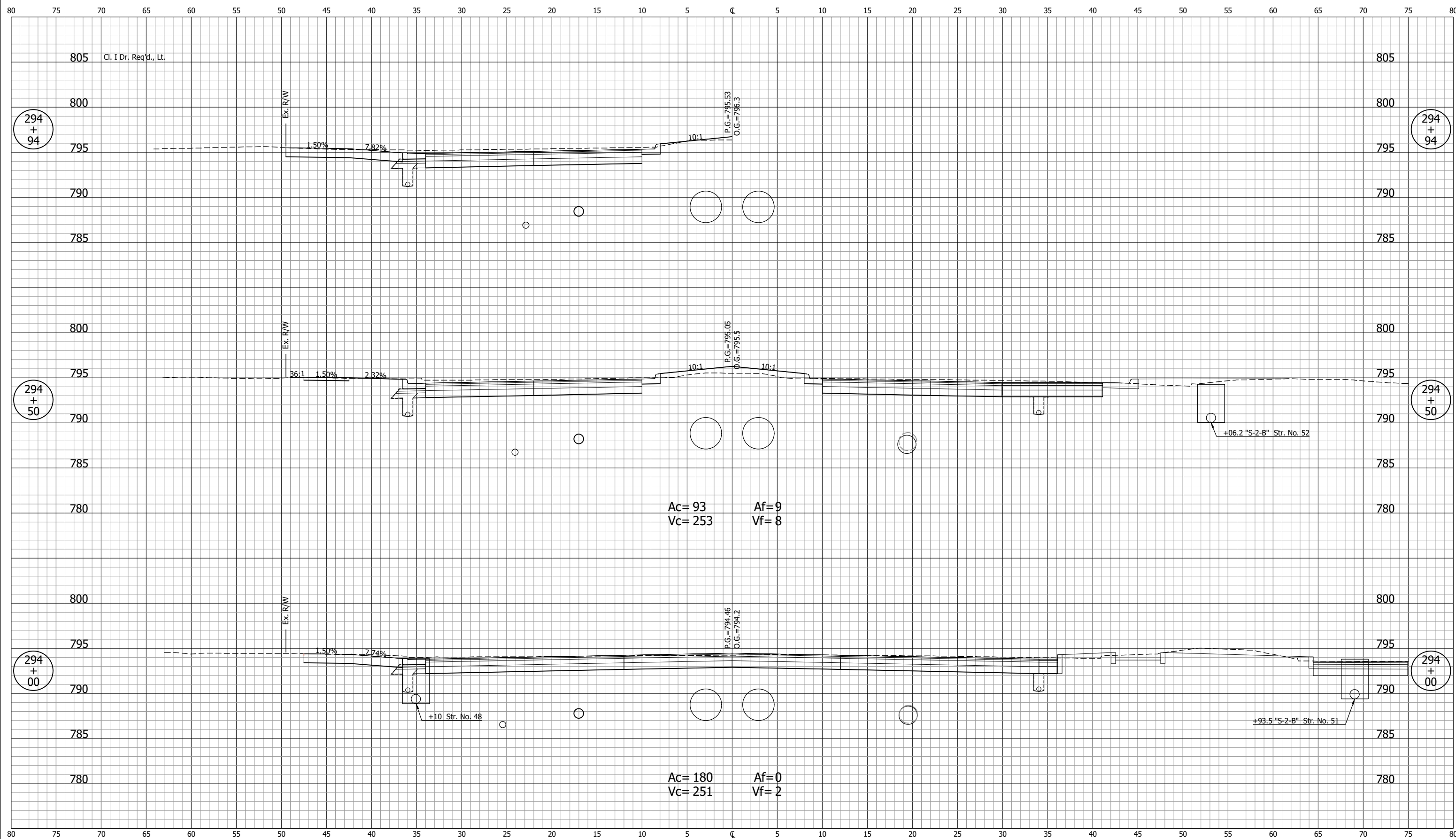

GDH - 2/9/2024 12:25 PM - U:\2021\202124 indot us35\Cad\C30\Design Files\212440D_C01.dwg (XS_5_B)

NOT FOR CONSTRUCTION		INDIANA DEPARTMENT OF TRANSPORTATION		SCALE 1" = 5'	BRIDGE FILE
		CROSS SECTIONS LINE "B"		DESIGNED: DGA	DRAWN: GDH
CHECKED: DGD	CHECKED: DGA			SURVEY BOOK	SHEETS 280 of 357
				CONTRACT R-43382	PROJECT 2001885

GDH - 2/9/2024 12:25 PM - U:\2021\202124.indot.us35\Cad\C30\Design Files\212440D_C01.dwg (XS_6_B)

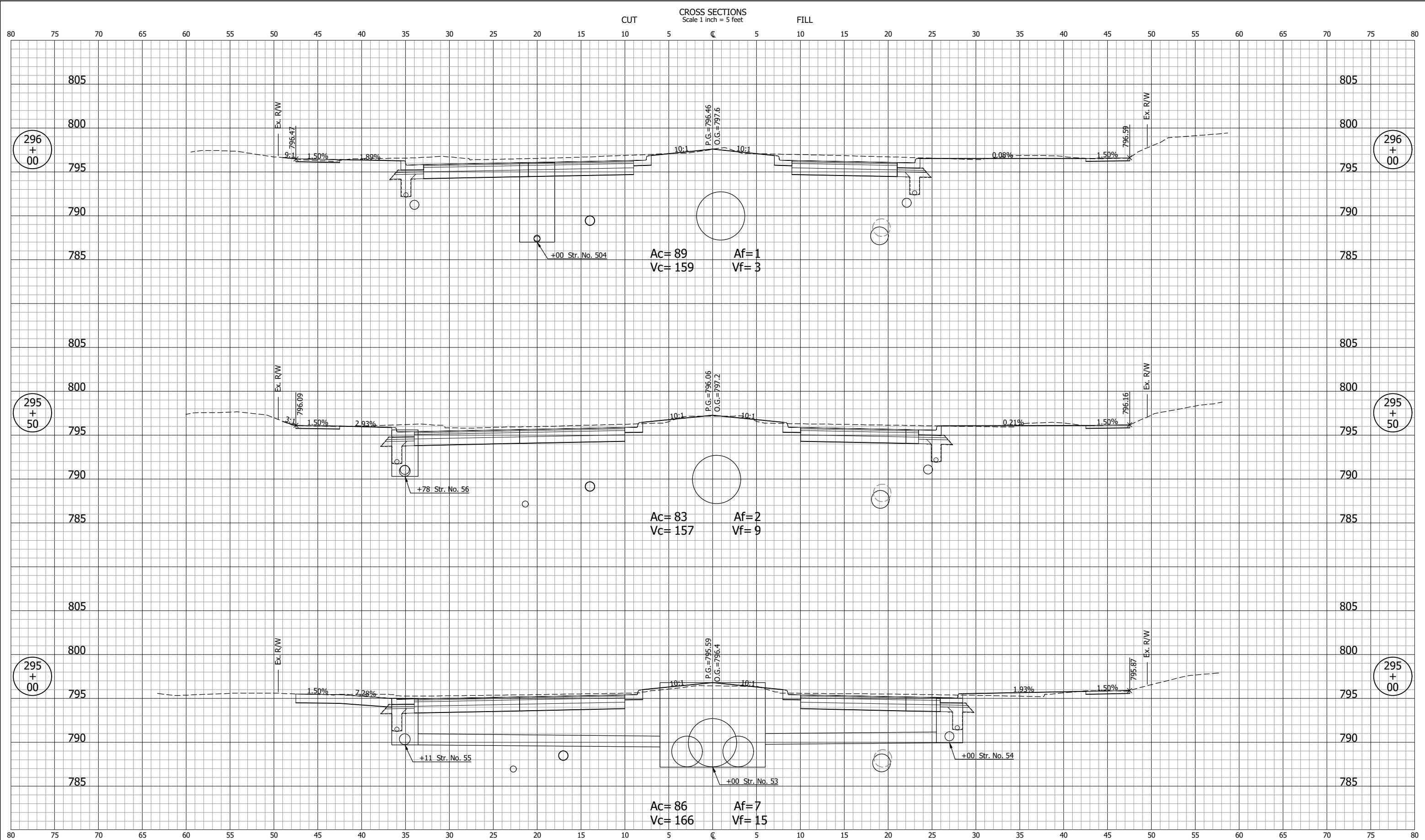

NOT FOR CONSTRUCTION		INDIANA DEPARTMENT OF TRANSPORTATION		SCALE 1" = 5'	BRIDGE FILE
DESIGNED: DGA		DRAWN: GDH		DESIGNATION 2001885 & 2101797	
CHECKED: DGD		CHECKED: DGA		SURVEY BOOK	SHEETS 281 of 357
CROSS SECTIONS LINE "B"				CONTRACT R-43382	PROJECT 2001885

CROSS SECTIONS
Scale 1 inch = 5 feet

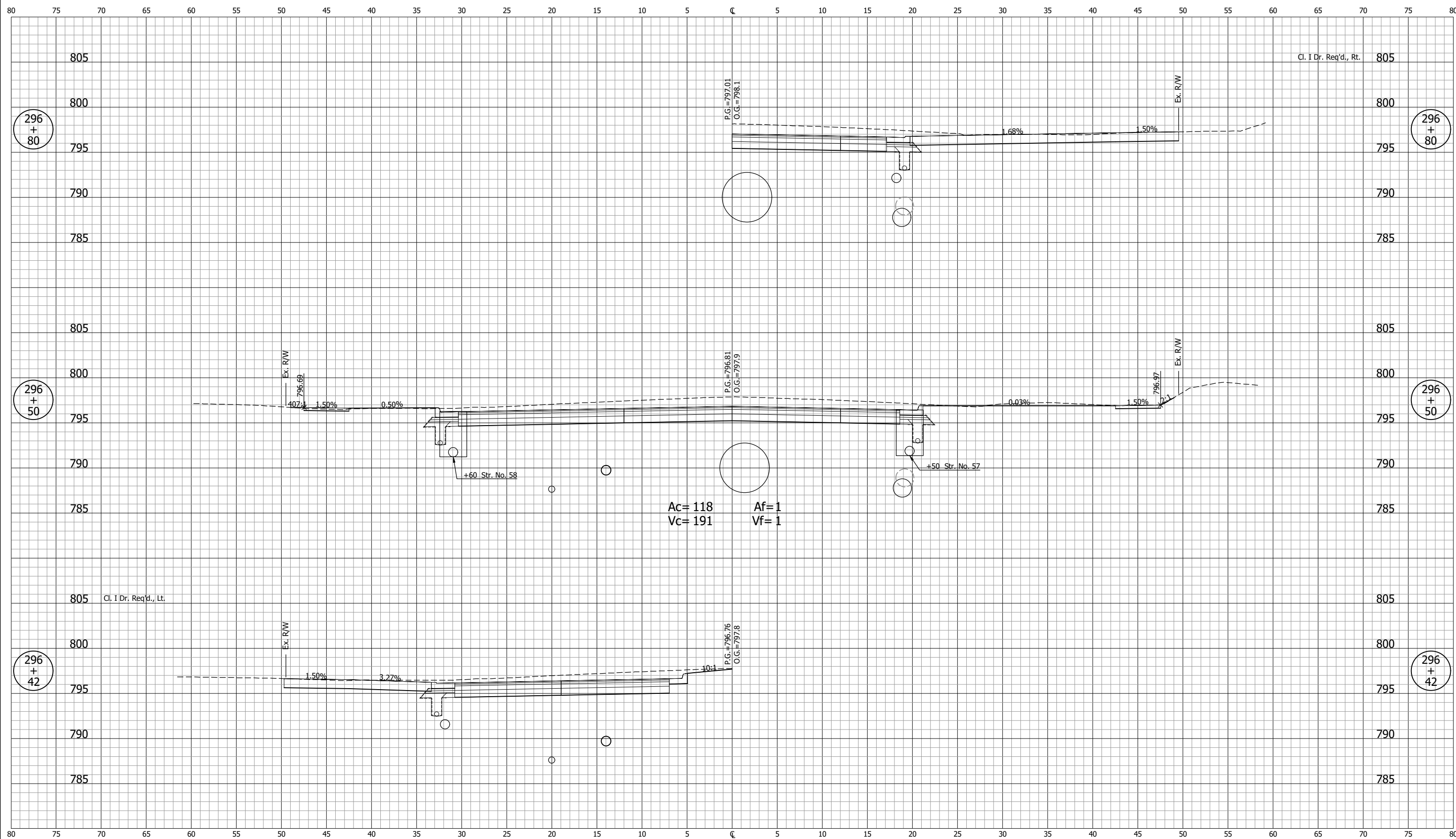

GDH - 2/9/2024 12:26 PM - U:\2021\202124 indot us35\Cad\C30\Design Files\212440D_CO1.dwg (XS_7_B)

NOT FOR CONSTRUCTION		INDIANA DEPARTMENT OF TRANSPORTATION		SCALE 1" = 5'	BRIDGE FILE
		CROSS SECTIONS LINE "B"		DESIGNATION 2001885 & 2101797	
SURVEY BOOK	SHEETS				
CONTRACT R-43382	282 of 357 PROJECT 2001885				

GDH - 2/9/2024 12:26 PM - U:\2021\202124.indot.us35\Cad\C30\Design Files\212440D_CO1.dwg (XS_8_B)

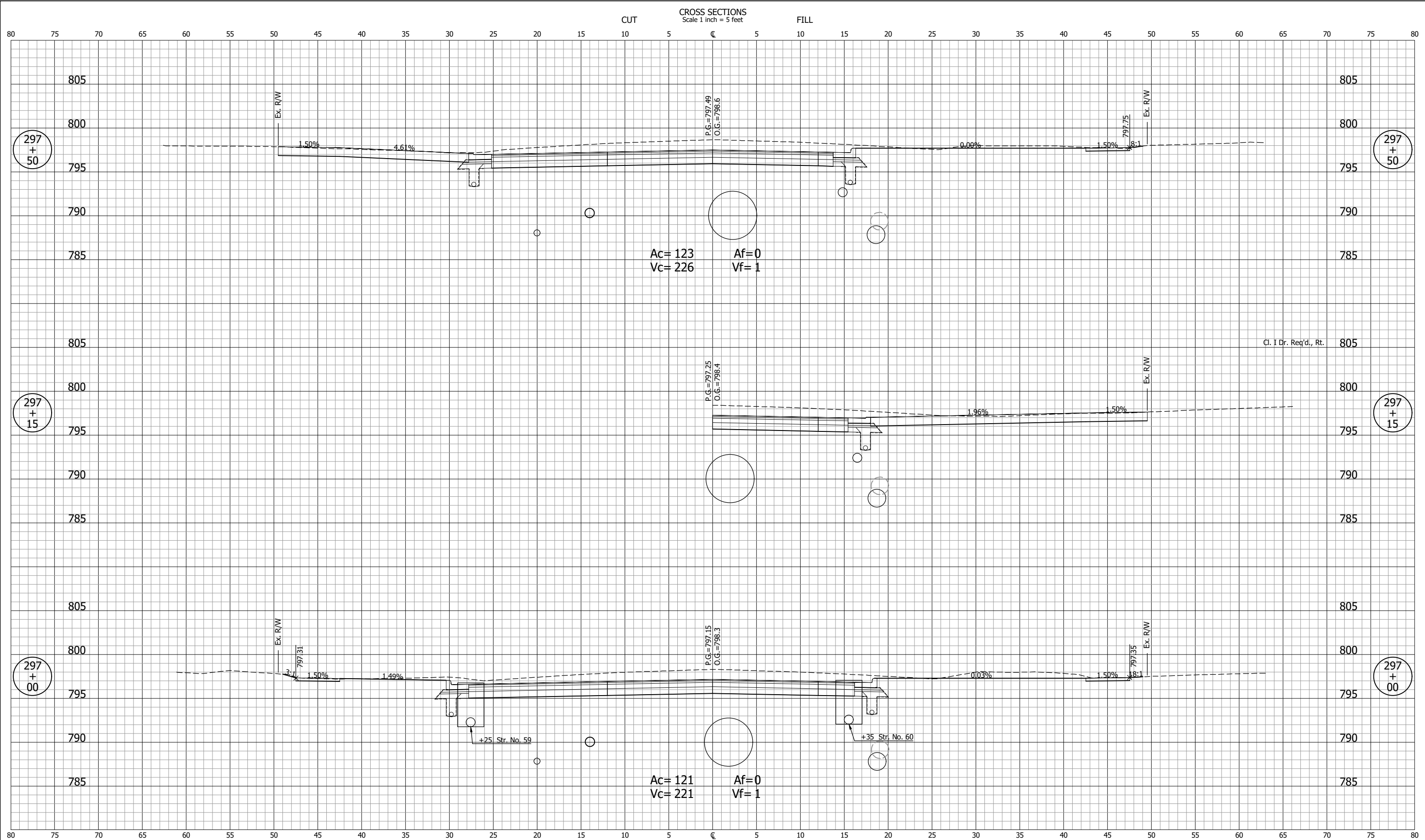

NOT FOR CONSTRUCTION		INDIANA DEPARTMENT OF TRANSPORTATION		SCALE 1" = 5'	BRIDGE FILE
DESIGNED: DGA		DRAWN: GDH		DESIGNATION 2001885 & 2101797	
CHECKED: DGD		CHECKED: DGA		SURVEY BOOK	SHEETS 283 of 357
CROSS SECTIONS LINE "B"				CONTRACT R-43382	PROJECT 2001885

CROSS SECTIONS
Scale 1 inch = 5 feet

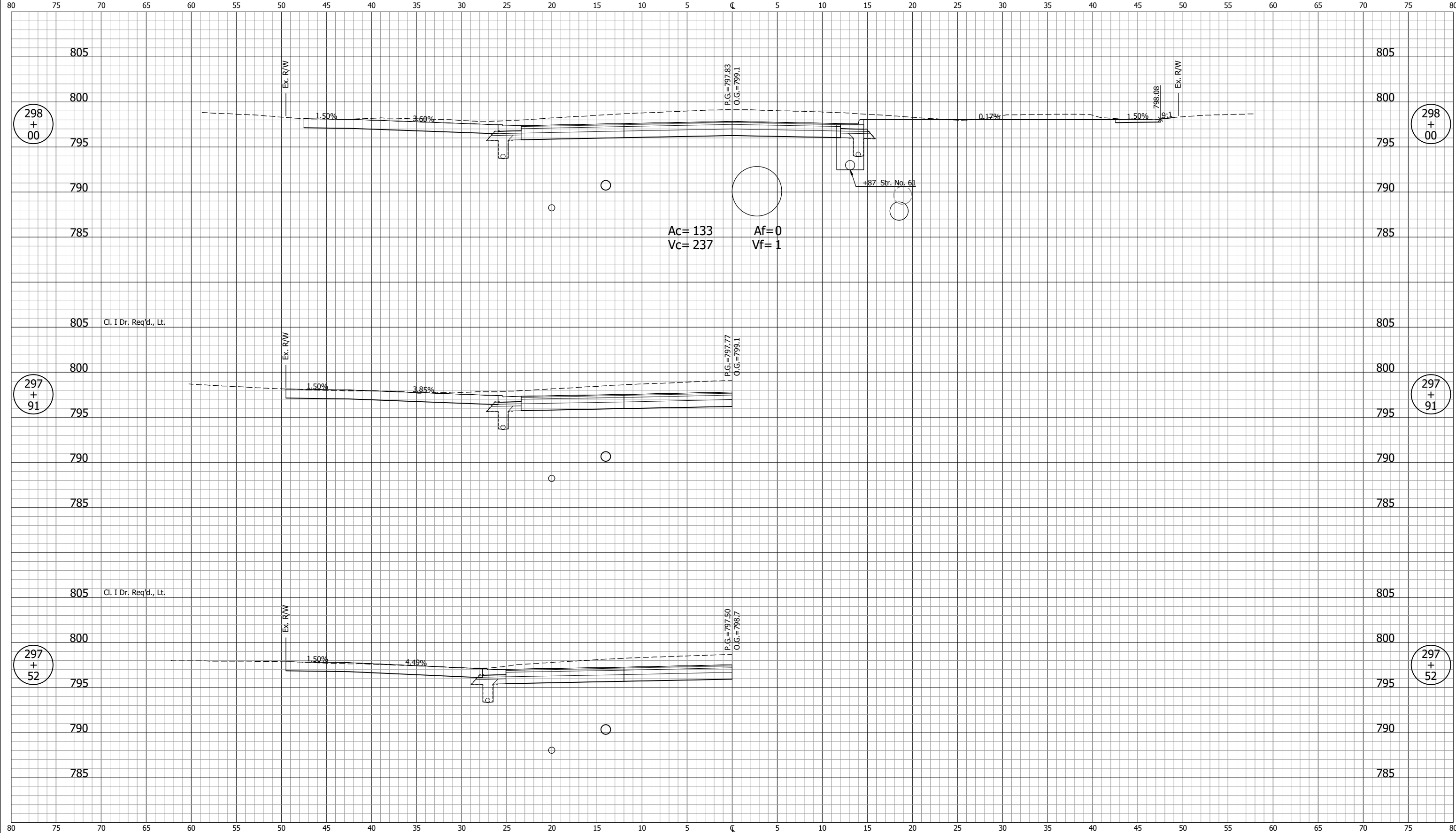

GDH - 2/9/2024 12:26 PM - U:\2021\202124.indot.us35\Cad\C30\Design Files\212440D_C01.dwg (XS_9_B)

NOT FOR CONSTRUCTION		INDIANA DEPARTMENT OF TRANSPORTATION		SCALE 1" = 5'	BRIDGE FILE
		CROSS SECTIONS LINE "B"		DESIGNATION 2001885 & 2101797	
SURVEY BOOK	SHEETS 284 of 357				
CONTRACT R-43382	PROJECT 2001885				

GDH - 2/9/2024 12:26 PM - U:\2021\202124.indot.us35\Cad\C30\Design Files\212440D_C01.dwg (XS_10_B)

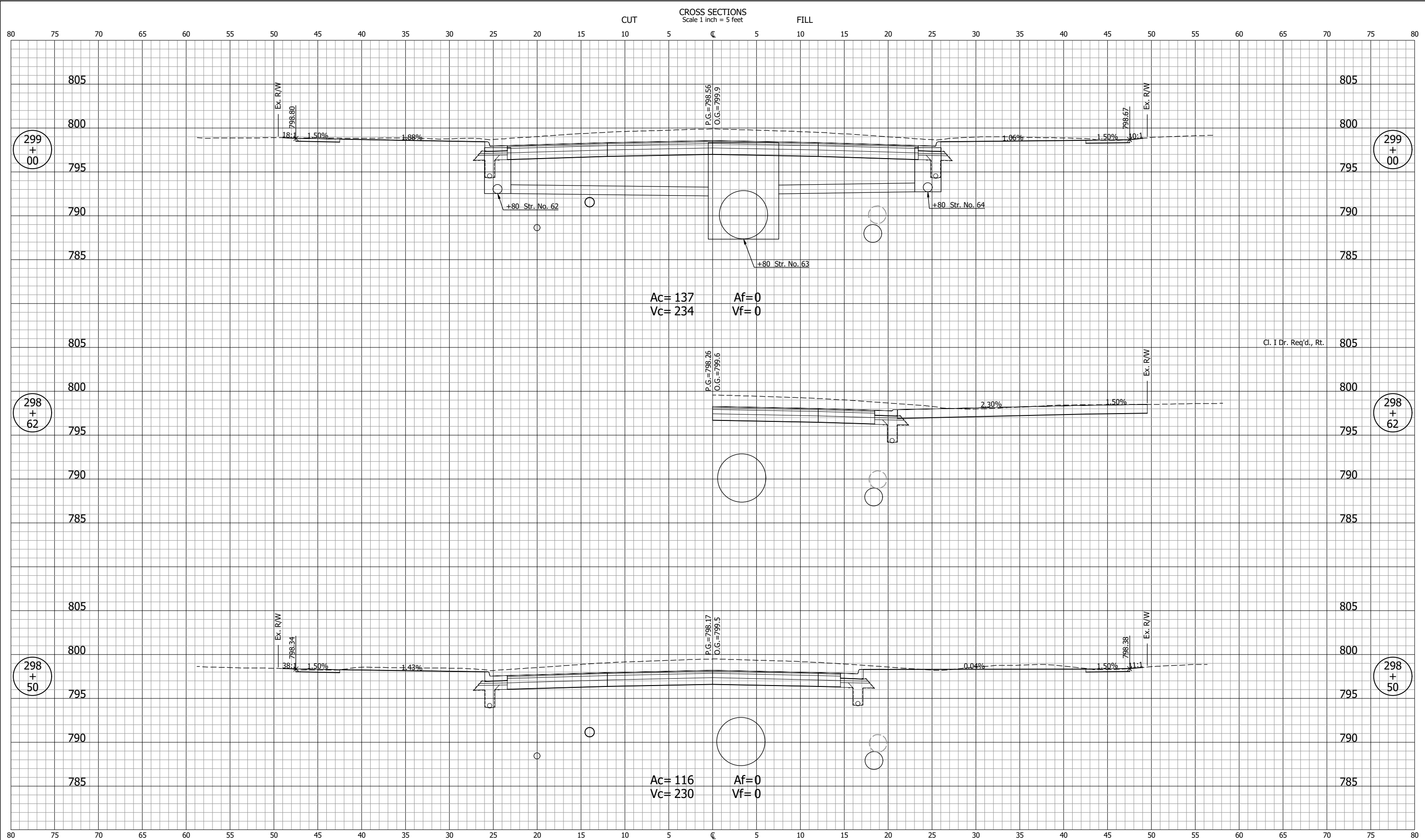

NOT FOR CONSTRUCTION		INDIANA DEPARTMENT OF TRANSPORTATION		SCALE 1" = 5'	BRIDGE FILE
DESIGNED: DGA		DRAWN: GDH		DESIGNATION 2001885 & 2101797	
CHECKED: DGD		CHECKED: DGA		SURVEY BOOK	SHEETS 285 of 357
		CROSS SECTIONS LINE "B"		CONTRACT R-43382	PROJECT 2001885

GDH - 2/9/2024 12:26 PM - U:\2021\202124.indot.us35\Cad\C30\Design Files\212440D_CO1.dwg (XS_11_B)

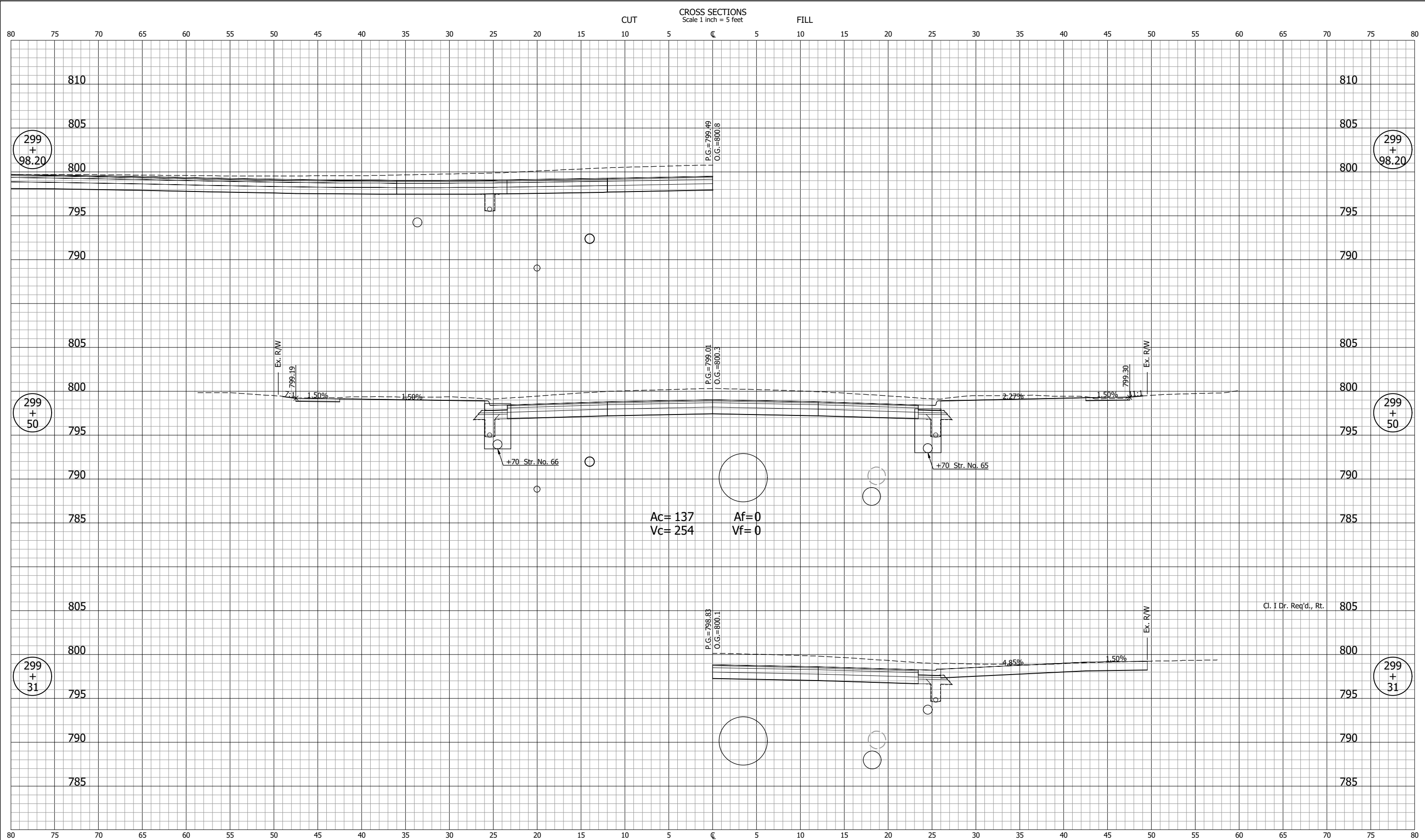

NOT FOR CONSTRUCTION

DESIGNED: DGA	DRAWN: GDH
CHECKED: DGD	CHECKED: DGA

**INDIANA
DEPARTMENT OF TRANSPORTATION**

**CROSS SECTIONS
LINE "B"**

SCALE 1" = 5'	BRIDGE FILE
	DESIGNATION 2001885 & 2101797
SURVEY BOOK	SHEETS 286 of 357
CONTRACT R-43382	PROJECT 2001885

GDH - 2/9/2024 12:26 PM - U:\2021\202124.indot.us35\Cad\C30\Design Files\212440D_C01.dwg (XS_12_B)

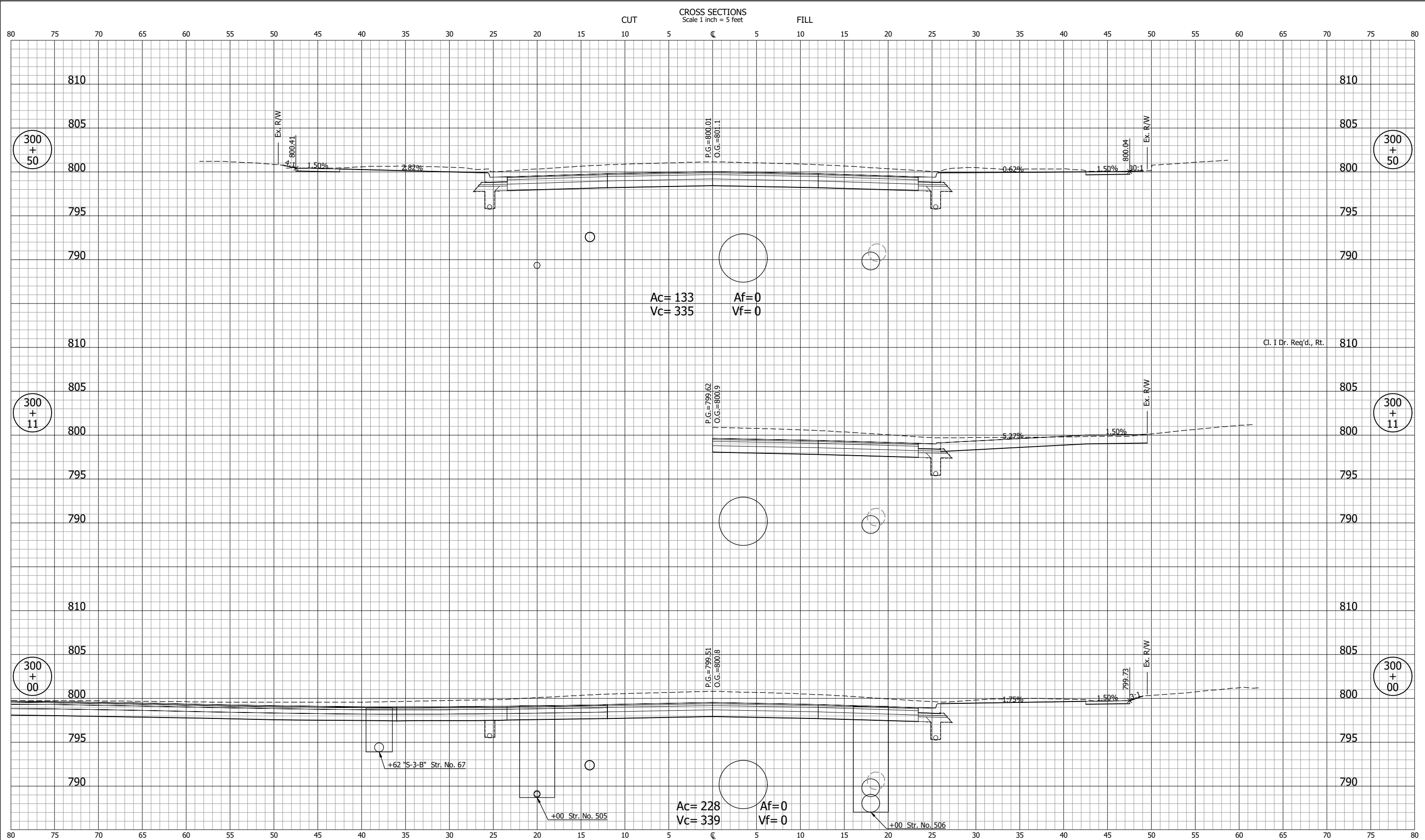

NOT FOR CONSTRUCTION

DESIGNED: DGA	DRAWN: GDH
CHECKED: DGD	CHECKED: DGA

**INDIANA
DEPARTMENT OF TRANSPORTATION**

**CROSS SECTIONS
LINE "B"**

SCALE 1" = 5'	BRIDGE FILE
	DESIGNATION 2001885 & 2101797
SURVEY BOOK	SHEETS 287 of 357
CONTRACT R-43382	PROJECT 2001885

GDH - 2/9/2024 12:26 PM - U:\2021\202124 indot us35\Cad\C30\Design Files\212440D_CO1.dwg (XS_15_B)

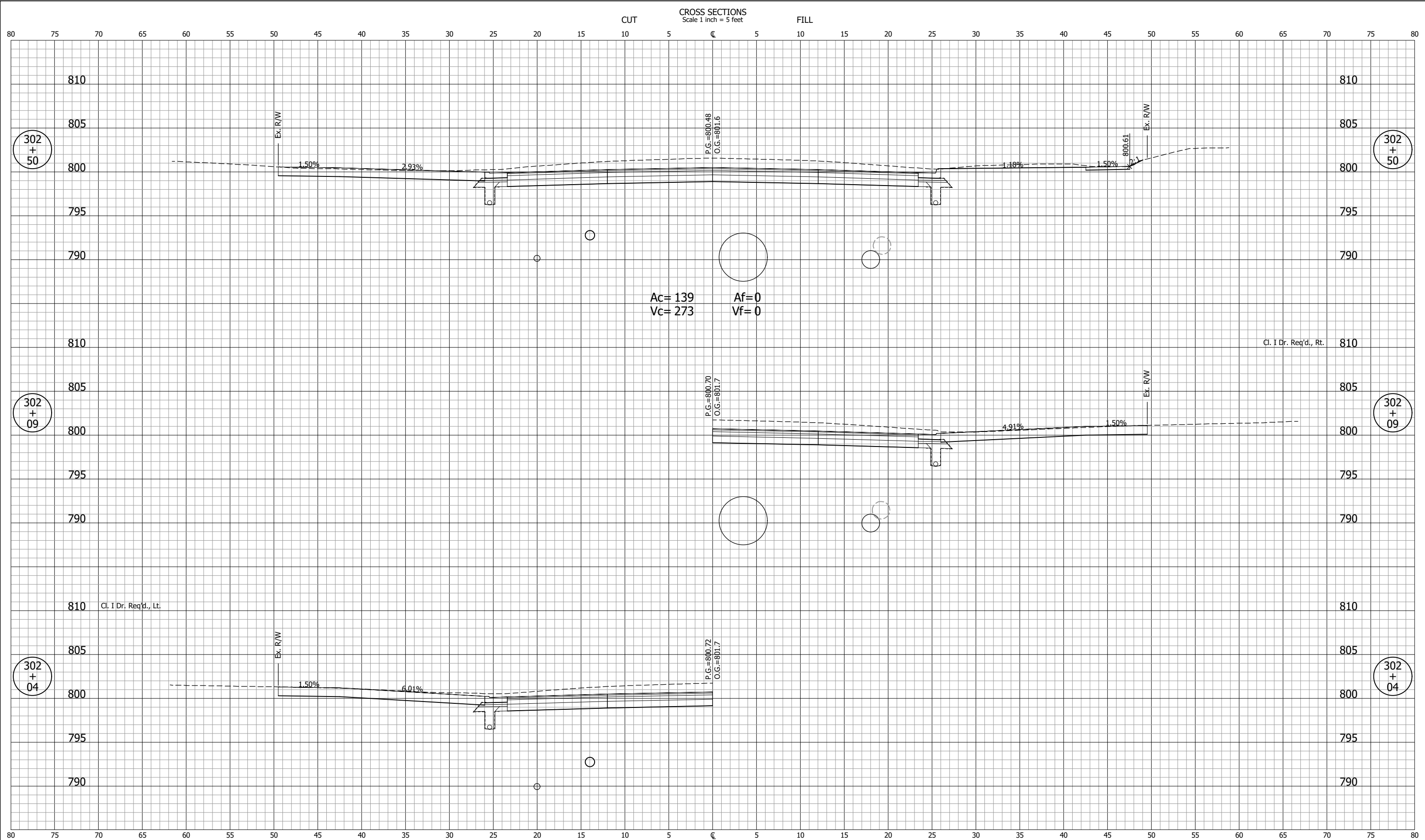

NOT FOR CONSTRUCTION		INDIANA DEPARTMENT OF TRANSPORTATION		SCALE 1" = 5'	BRIDGE FILE
DESIGNED: DGA		DRAWN: GDH		DESIGNATION 2001885 & 2101797	
CHECKED: DGD		CHECKED: DGA		SURVEY BOOK	SHEETS 290 of 357
		CROSS SECTIONS LINE "B"		CONTRACT R-43382	PROJECT 2001885

GDH - 2/9/2024 12:26 PM - U:\2021\202124 indot us35\Cad\C30\Design Files\212440D_CO1.dwg (XS_16_B)

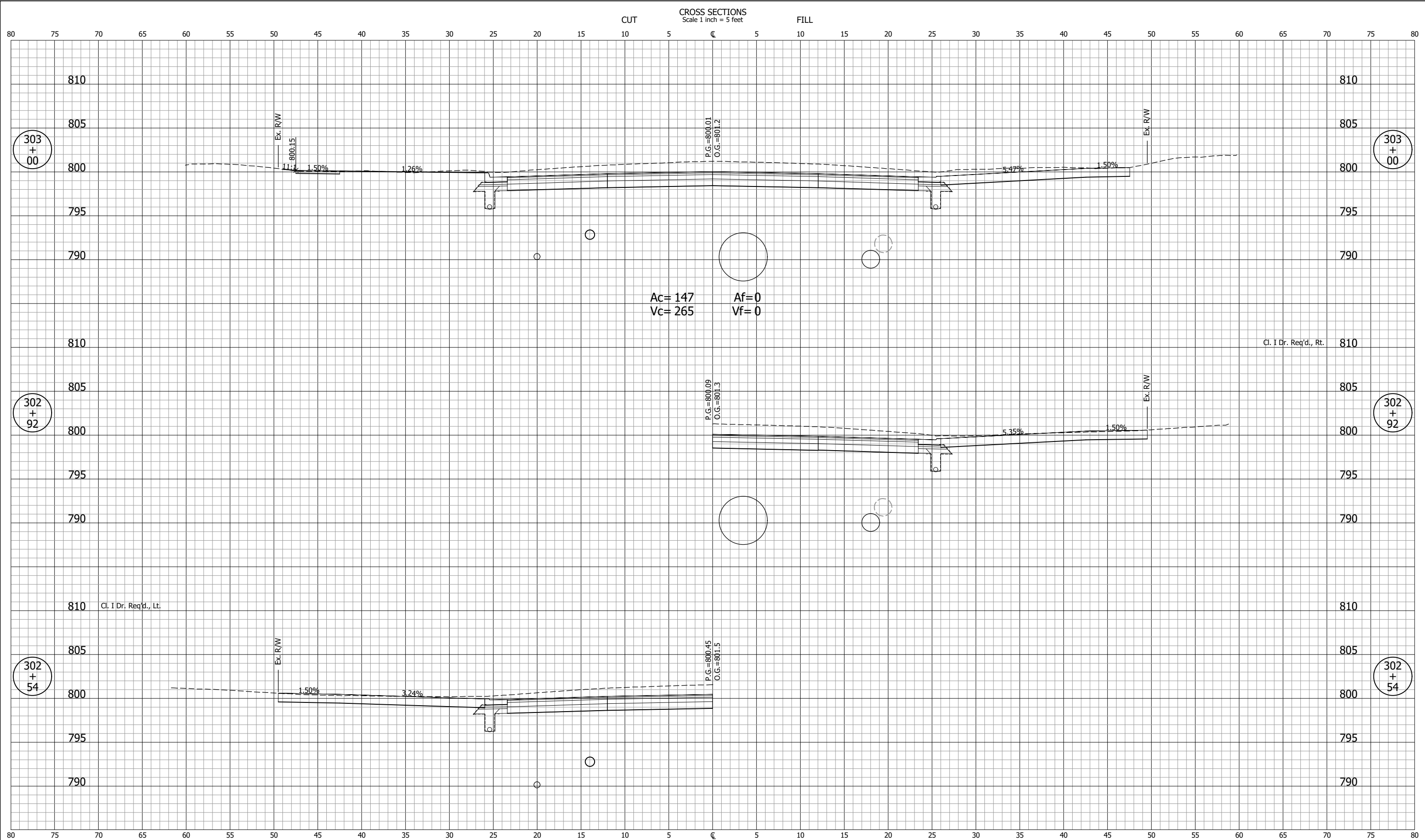

NOT FOR CONSTRUCTION		INDIANA DEPARTMENT OF TRANSPORTATION		SCALE 1" = 5'	BRIDGE FILE
DESIGNED: DGA		DRAWN: GDH		DESIGNATION 2001885 & 2101797	
CHECKED: DGD		CHECKED: DGA		SURVEY BOOK	SHEETS 291 of 357
		CROSS SECTIONS LINE "B"		CONTRACT R-43382	PROJECT 2001885

GDH - 2/9/2024 12:26 PM - U:\2021\202124.indot.us35\Cad\C30\Design Files\212440D_C01.dwg (XS_17_B)

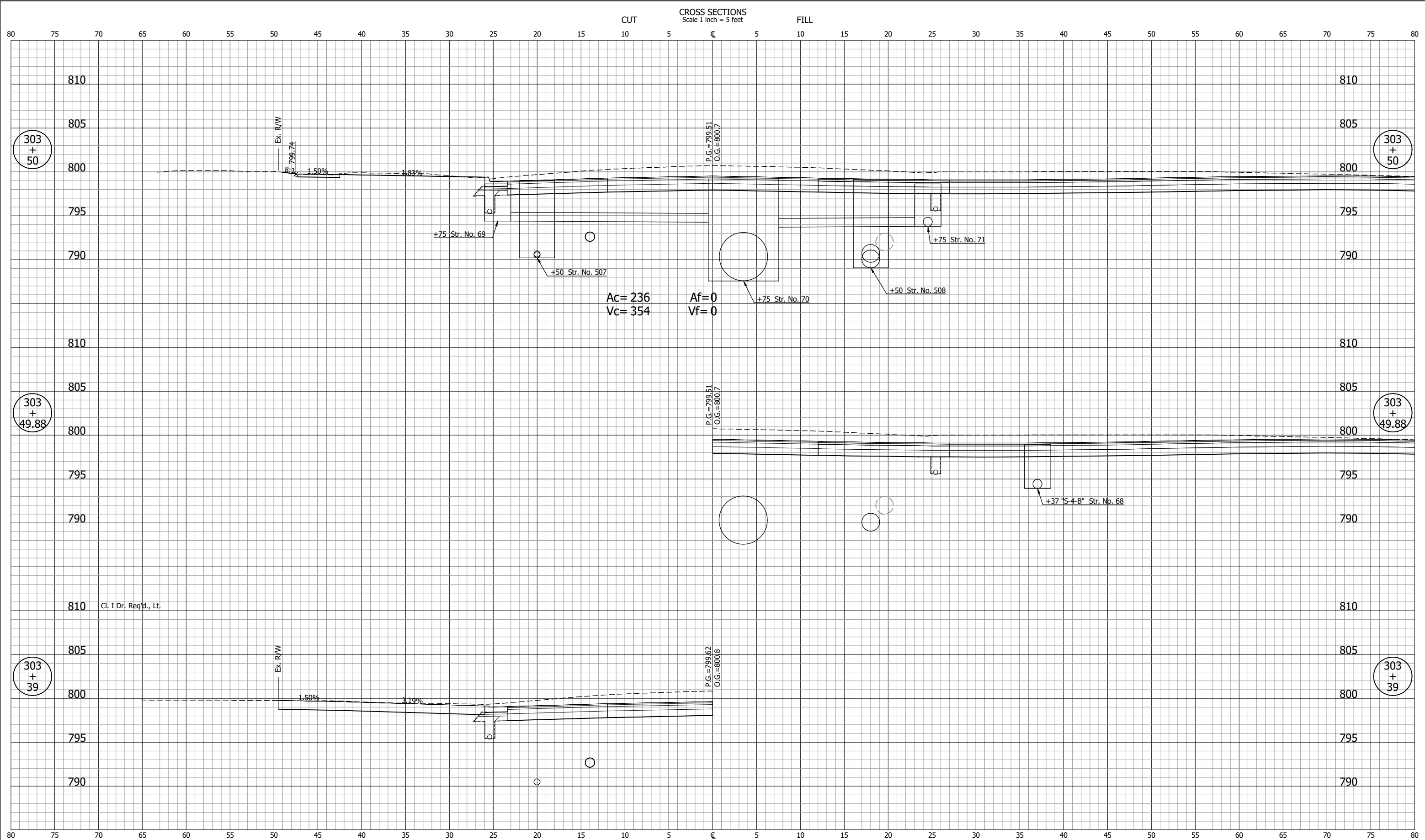

NOT FOR CONSTRUCTION		INDIANA DEPARTMENT OF TRANSPORTATION		SCALE 1" = 5'	BRIDGE FILE
		CROSS SECTIONS LINE "B"		DESIGNATION 2001885 & 2101797	
DESIGNED: DGA	DRAWN: GDH			SURVEY BOOK	SHEETS
CHECKED: DGD	CHECKED: DGA			CONTRACT R-43382	292 of 357 PROJECT 2001885

CROSS SECTIONS
Scale 1 inch = 5 feet

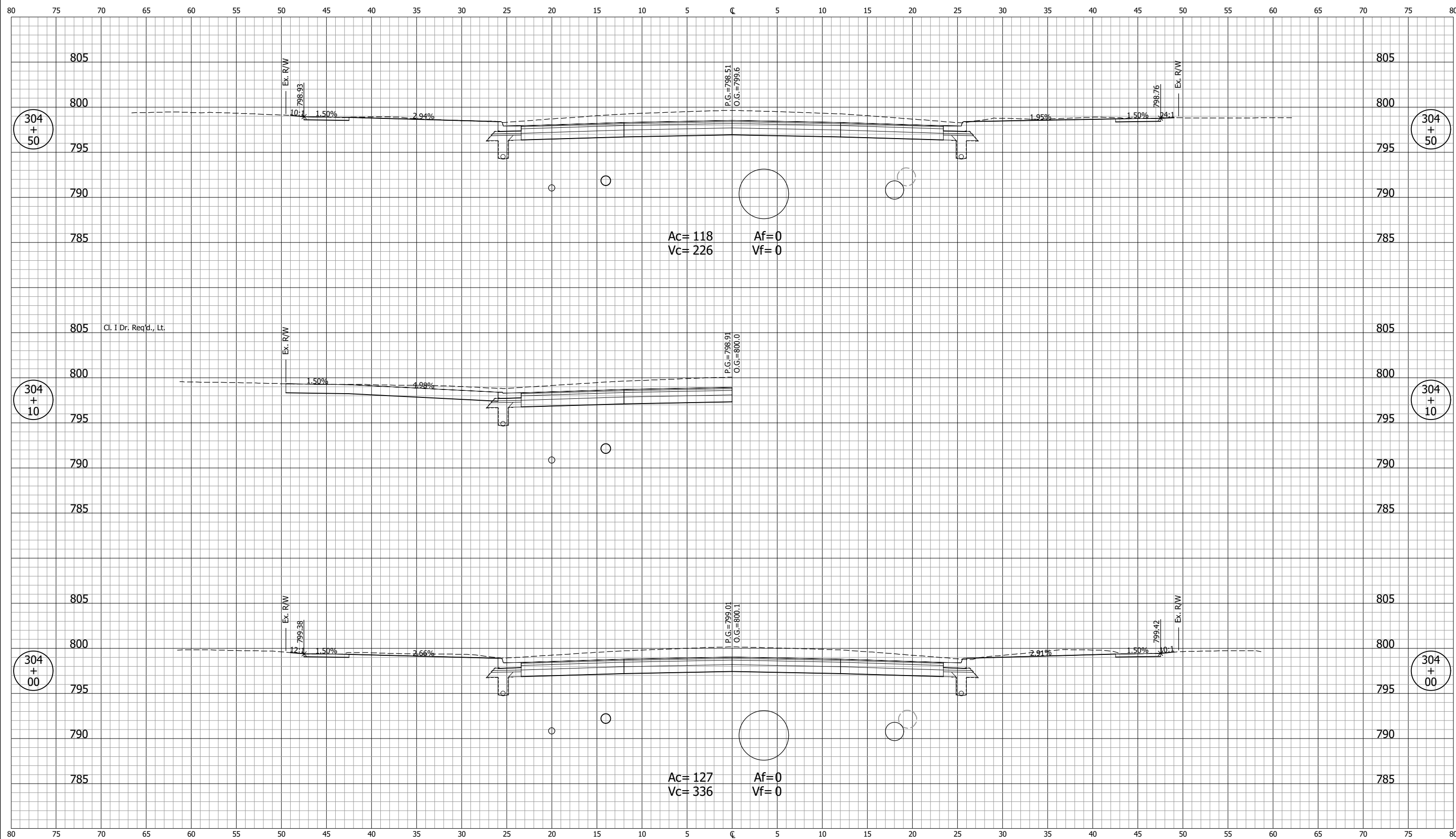

GDH - 2/9/2024 12:26 PM - U:\2021\202124.indot.us35\Cad\C30\Design Files\212440D_C01.dwg (XS_18_B)

NOT FOR CONSTRUCTION		INDIANA DEPARTMENT OF TRANSPORTATION		SCALE 1" = 5'	BRIDGE FILE
		CROSS SECTIONS LINE "B"		DESIGNATION 2001885 & 2101797	
DESIGNED: DGA	DRAWN: GDH			SURVEY BOOK	SHEETS 293 of 357
CHECKED: DGD	CHECKED: DGA	CONTRACT R-43382		PROJECT 2001885	

CROSS SECTIONS
Scale 1 inch = 5 feet

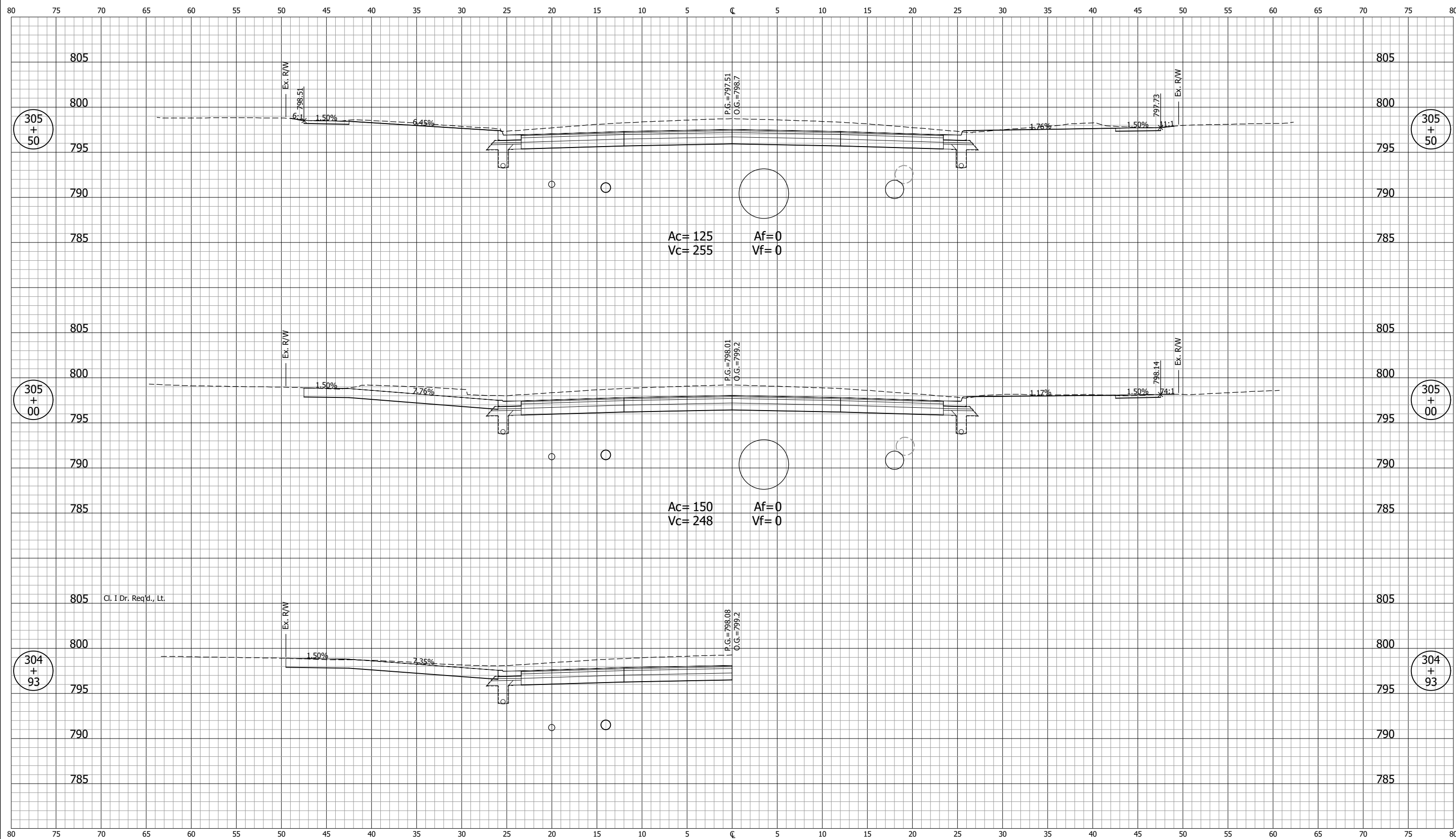

Ac= 125
Vc= 255
Af= 0
Vf= 0

Ac= 150
Vc= 248
Af= 0
Vf= 0

Cl. I Dr. Req'd., Lt.

NOT FOR CONSTRUCTION		INDIANA DEPARTMENT OF TRANSPORTATION		SCALE	BRIDGE FILE
				1" = 5'	
DESIGNED: DGA DRAWN: GDH		CROSS SECTIONS LINE "B"		DESIGNATION	
				2001885 & 2101797	
CHECKED: DGD CHECKED: DGA				SURVEY BOOK	SHEETS
				R-43382	294 of 357
				CONTRACT	PROJECT
				R-43382	2001885

GDH - 2/9/2024 12:27 PM - U:\2021\202124 indot us35\Cad\C30\Design Files\212440D_CO1.dwg (XS_19_B)

CROSS SECTIONS
Scale 1 inch = 5 feet

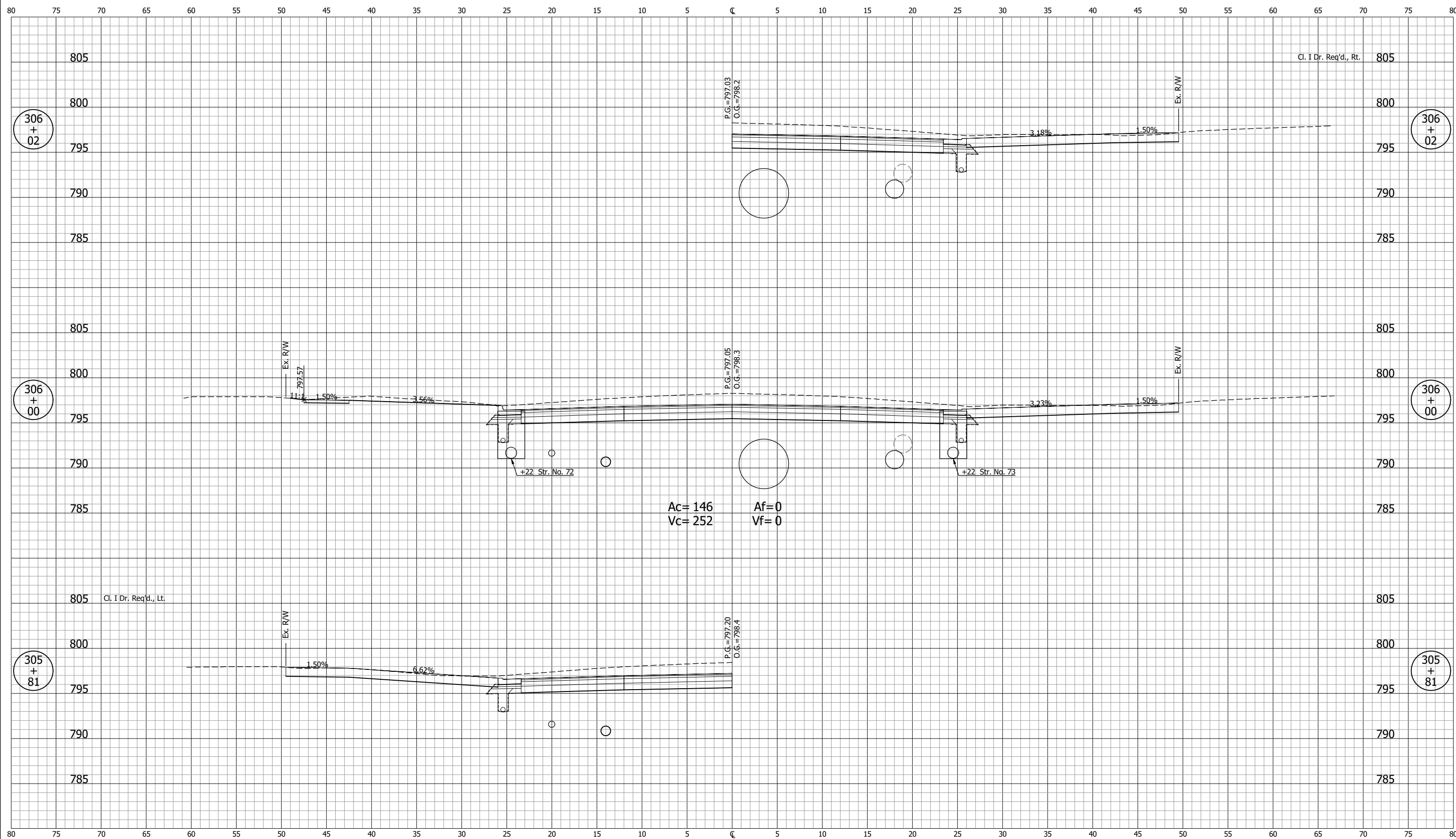

GDH - 2/9/2024 12:27 PM - U:\2021\202124.indot.us35\Cad\C30\Design Files\212440D_CO1.dwg (XS_20_B)

NOT FOR CONSTRUCTION		INDIANA DEPARTMENT OF TRANSPORTATION		SCALE 1" = 5'	BRIDGE FILE
		CROSS SECTIONS LINE "B"		DESIGNATION 2001885 & 2101797	
DESIGNED: DGA	DRAWN: GDH			SURVEY BOOK	SHEETS 295 of 357
CHECKED: DGD	CHECKED: DGA	CONTRACT R-43382		PROJECT 2001885	

GDH - 2/9/2024 12:27 PM - U:\2021\202124 indot us35\Cad\C30\Design Files\212440D_CO1.dwg (XS_21_B)

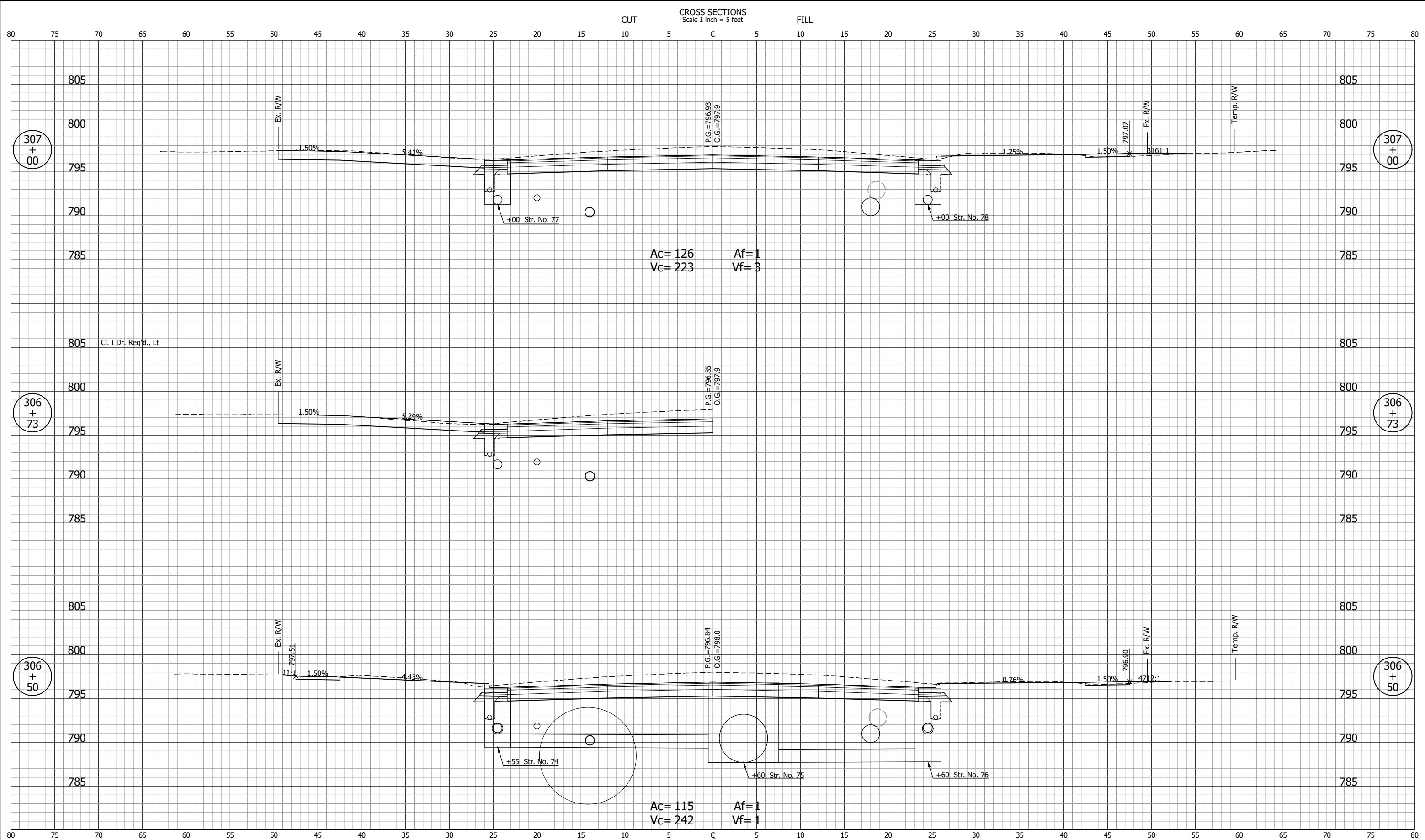

NOT FOR CONSTRUCTION

DESIGNED: DGA	DRAWN: GDH
CHECKED: DGD	CHECKED: DGA

**INDIANA
DEPARTMENT OF TRANSPORTATION**

**CROSS SECTIONS
LINE "B"**

SCALE 1" = 5'	BRIDGE FILE
SURVEY BOOK	SHEETS 296 of 357
CONTRACT R-43382	PROJECT 2001885

CROSS SECTIONS
Scale 1 inch = 5 feet

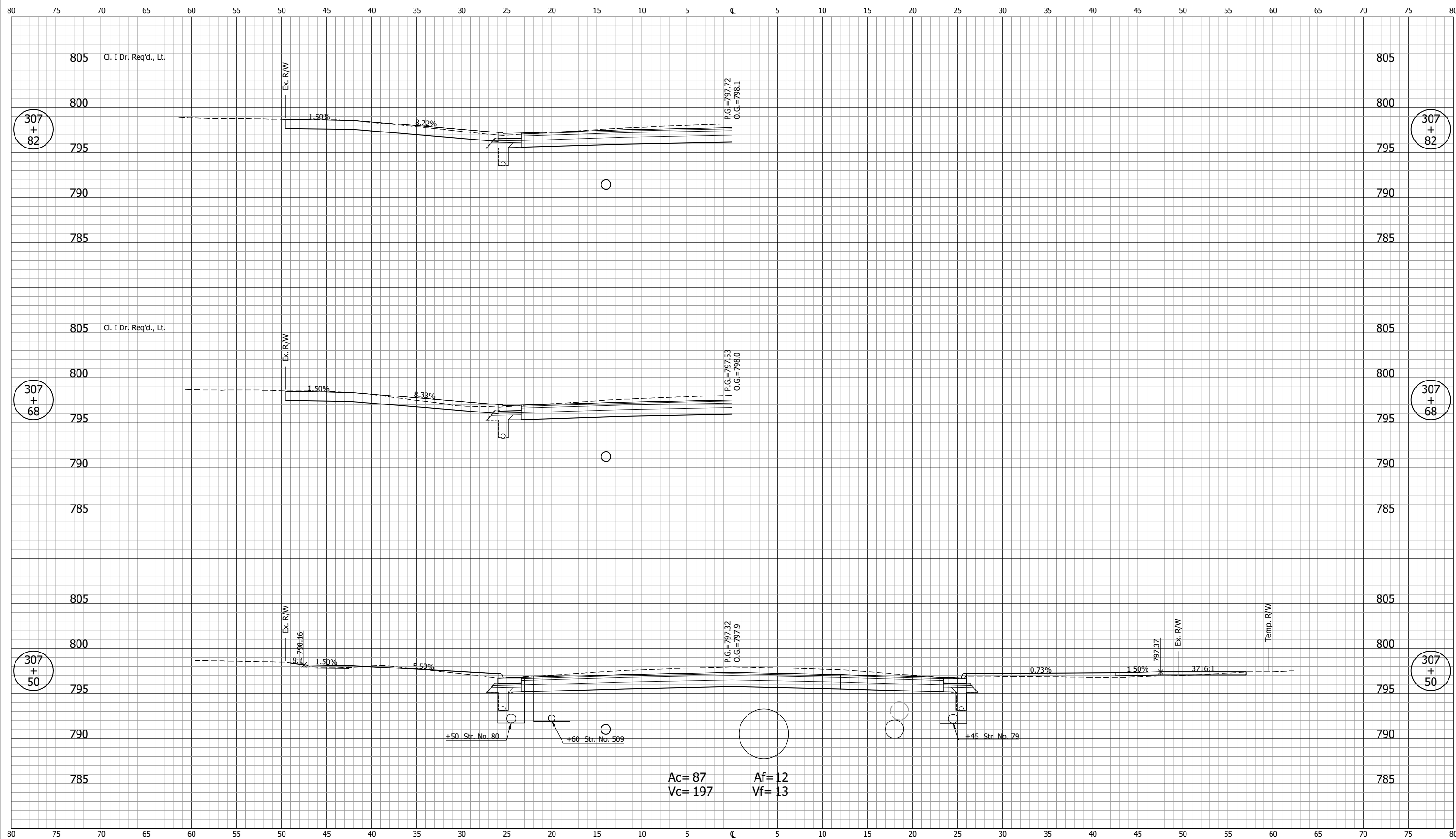

Ac= 87
Vc= 197
Af= 12
Vf= 13

+50 Str. No. 80
+60 Str. No. 509
+45 Str. No. 79

NOT FOR CONSTRUCTION

DESIGNED: DGA
DRAWN: GDH
CHECKED: DGD
CHECKED: DGA

INDIANA
DEPARTMENT OF TRANSPORTATION

**CROSS SECTIONS
LINE "B"**

SCALE 1" = 5'	BRIDGE FILE
	DESIGNATION 2001885 & 2101797
SURVEY BOOK	SHEETS 297 of 357
CONTRACT R-43382	PROJECT 2001885

GDH - 2/9/2024 12:27 PM - U:\2021\202124 indot us35\Cad\C30\Design Files\212440D_CO1.dwg (XS_22_B)

GDH - 2/9/2024 12:27 PM - U:\2021\202124 indot us35\Cad\C30\Design Files\212440D_CO1.dwg (XS_23_B)

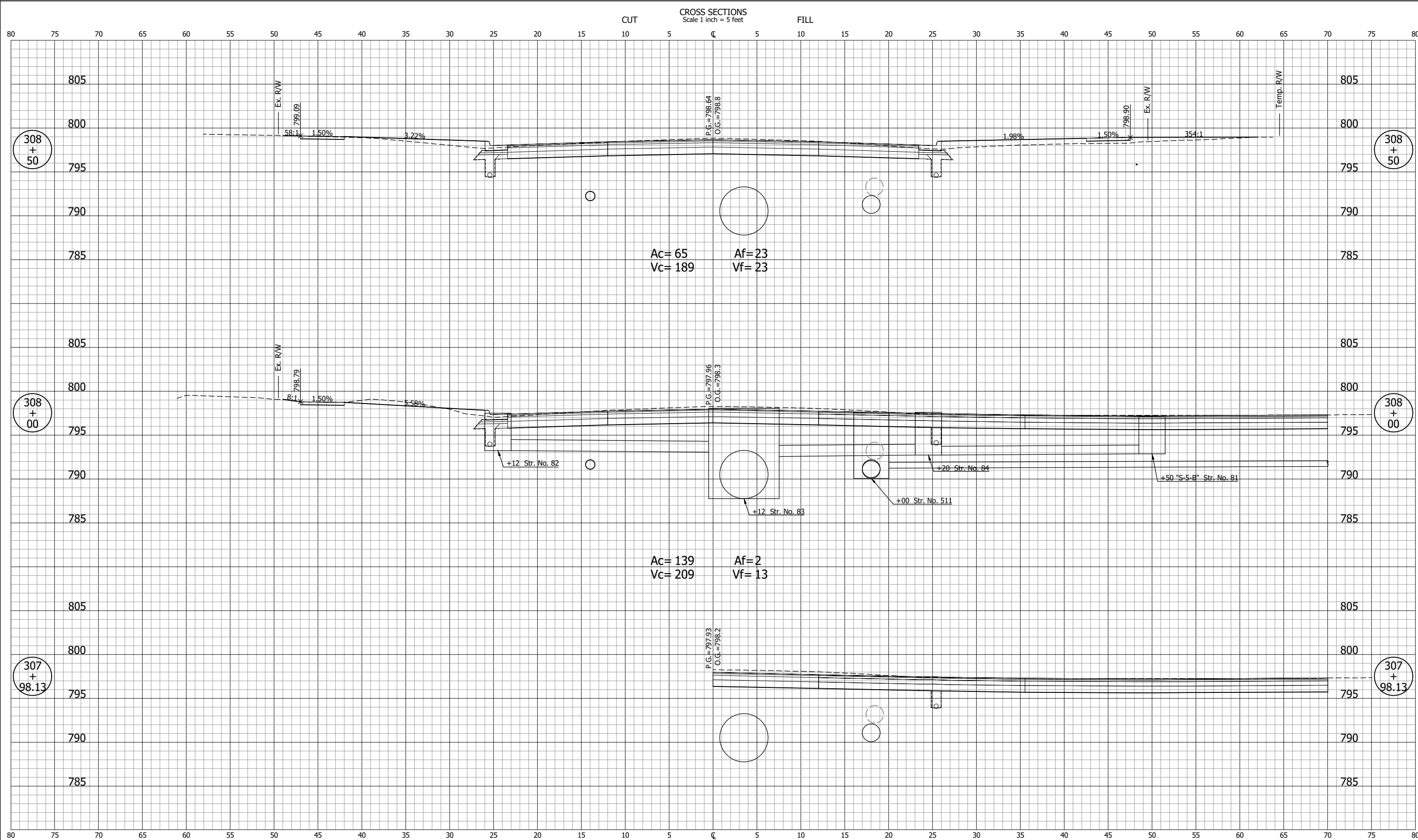

NOT FOR CONSTRUCTION		INDIANA DEPARTMENT OF TRANSPORTATION		SCALE 1" = 5'	BRIDGE FILE
		CROSS SECTIONS LINE "B"		DESIGNATION 2001885 & 2101797	
DESIGNED: DGA	DRAWN: GDH			SURVEY BOOK	SHEETS 298 of 357
CHECKED: DGD	CHECKED: DGA			CONTRACT R-43382	PROJECT 2001885

GDH - 2/9/2024 12:27 PM - U:\2021\202124 indot us35\Cad\C30\Design Files\212440D_C01.dwg (XS_24_B)

CROSS SECTIONS
Scale 1 inch = 5 feet

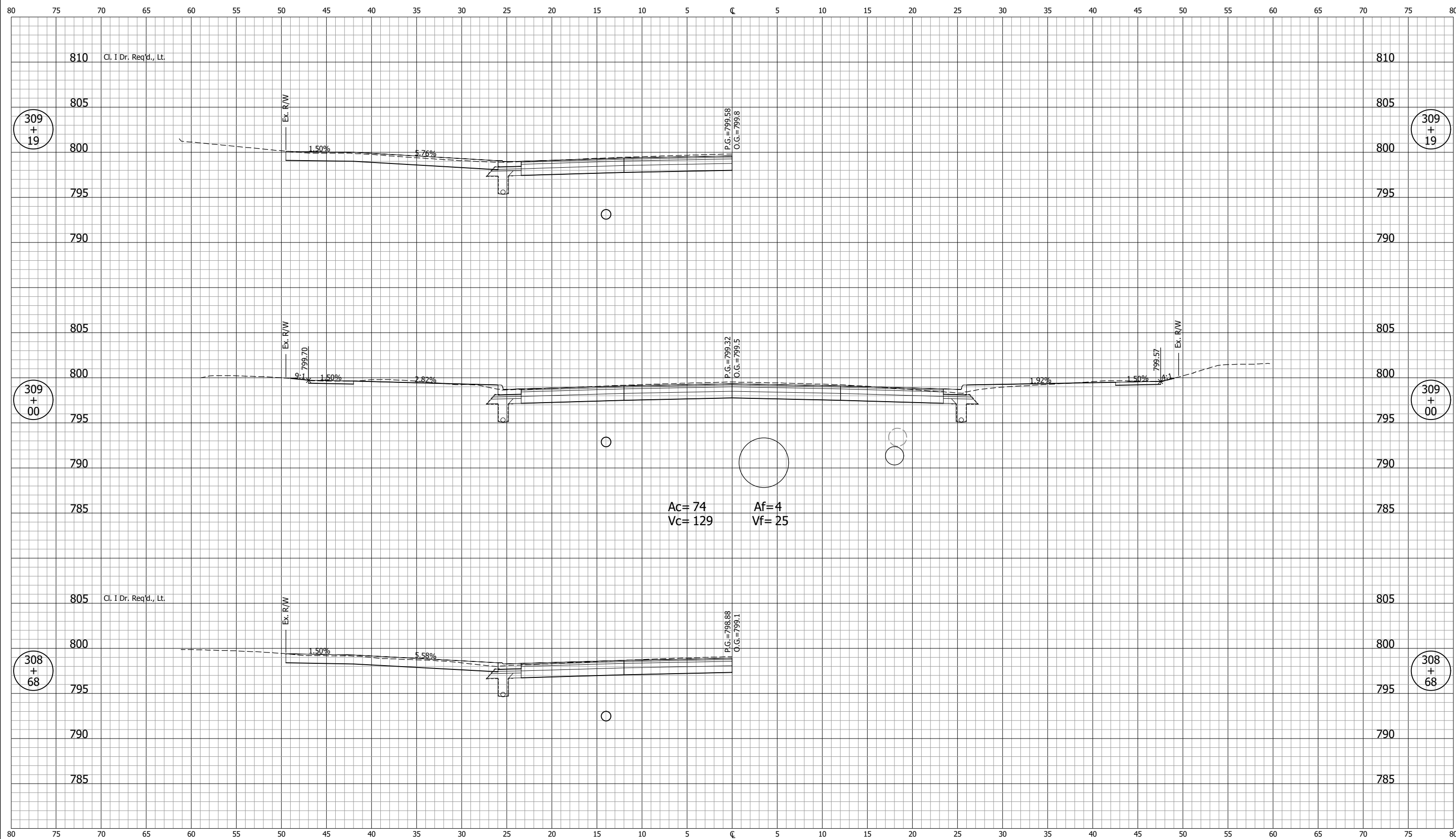

NOT FOR CONSTRUCTION		INDIANA DEPARTMENT OF TRANSPORTATION		SCALE 1" = 5'	BRIDGE FILE
DESIGNED: DGA		DRAWN: GDH		DESIGNATION 2001885 & 2101797	
CHECKED: DGD		CHECKED: DGA		SURVEY BOOK	SHEETS 299 of 357
		CROSS SECTIONS LINE "B"		CONTRACT R-43382	PROJECT 2001885

GDH - 2/9/2024 12:27 PM - U:\2021\202124 indot us35\Cad\C30\Design Files\212440D_CO1.dwg (XS_25_B)

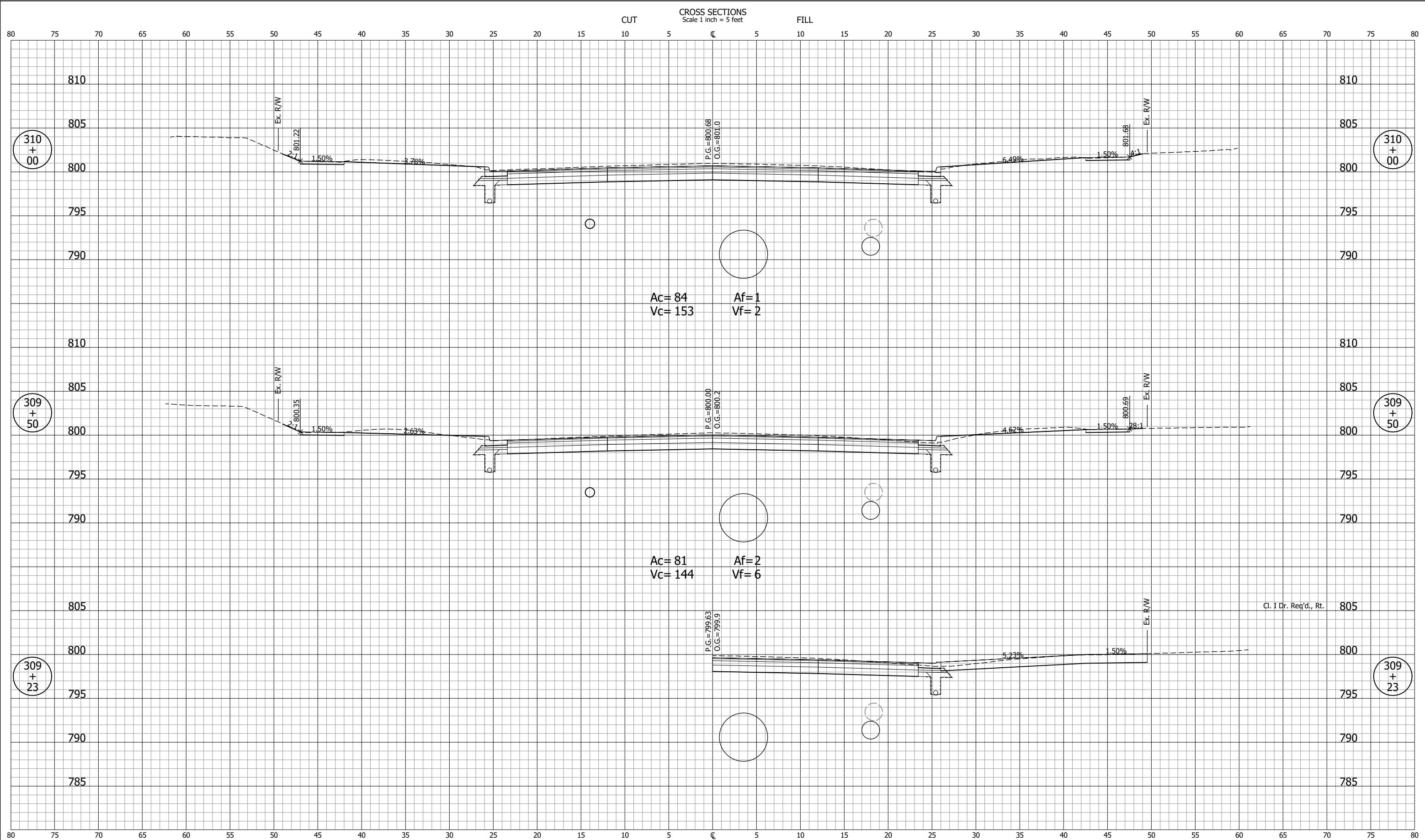

NOT FOR CONSTRUCTION		INDIANA DEPARTMENT OF TRANSPORTATION		SCALE 1" = 5'	BRIDGE FILE
		CROSS SECTIONS LINE "B"		DESIGNATION 2001885 & 2101797	
DESIGNED: DGA	DRAWN: GDH			SURVEY BOOK	SHEETS 300 of 357
CHECKED: DGD	CHECKED: DGA			CONTRACT R-43382	PROJECT 2001885

GDH - 2/9/2024 12:27 PM - U:\2021\202124 indot us35\Cad\C30\Design Files\212440D_CO1.dwg (XS_26_B)

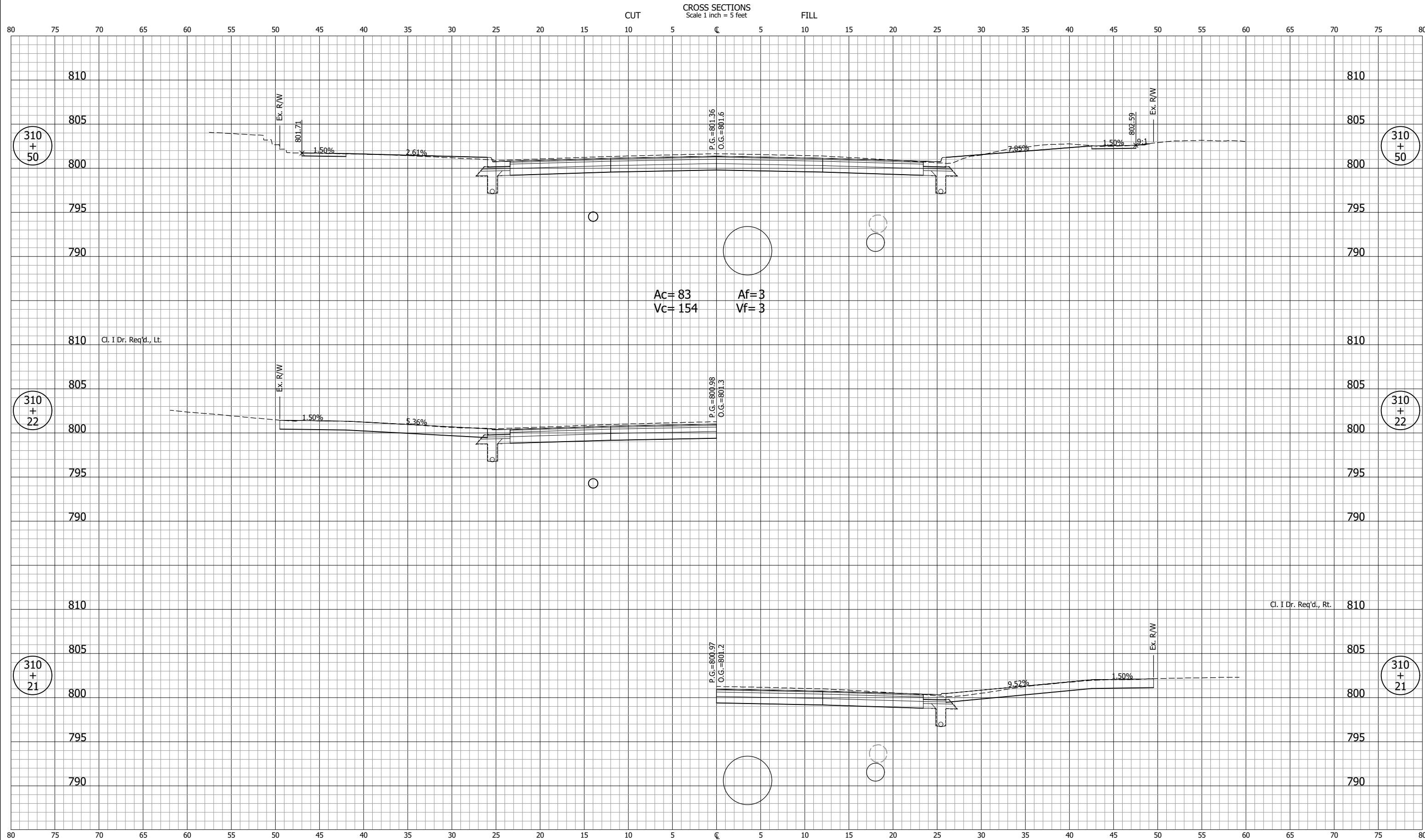

CROSS SECTIONS
Scale 1 inch = 5 feet

Ac= 83
Vc= 154
Af= 3
Vf= 3

NOT FOR CONSTRUCTION

DESIGNED: DGA	DRAWN: GDH
CHECKED: DGD	CHECKED: DGA

INDIANA
DEPARTMENT OF TRANSPORTATION

**CROSS SECTIONS
LINE "B"**

SCALE 1" = 5'	BRIDGE FILE
	DESIGNATION 2001885 & 2101797
SURVEY BOOK	SHEETS 301 of 357
CONTRACT R-43382	PROJECT 2001885

GDH - 2/9/2024 12:27 PM - U:\2021\202124.indot.us35\Cad\C30\Design Files\212440D_CO1.dwg (XS_27_B)

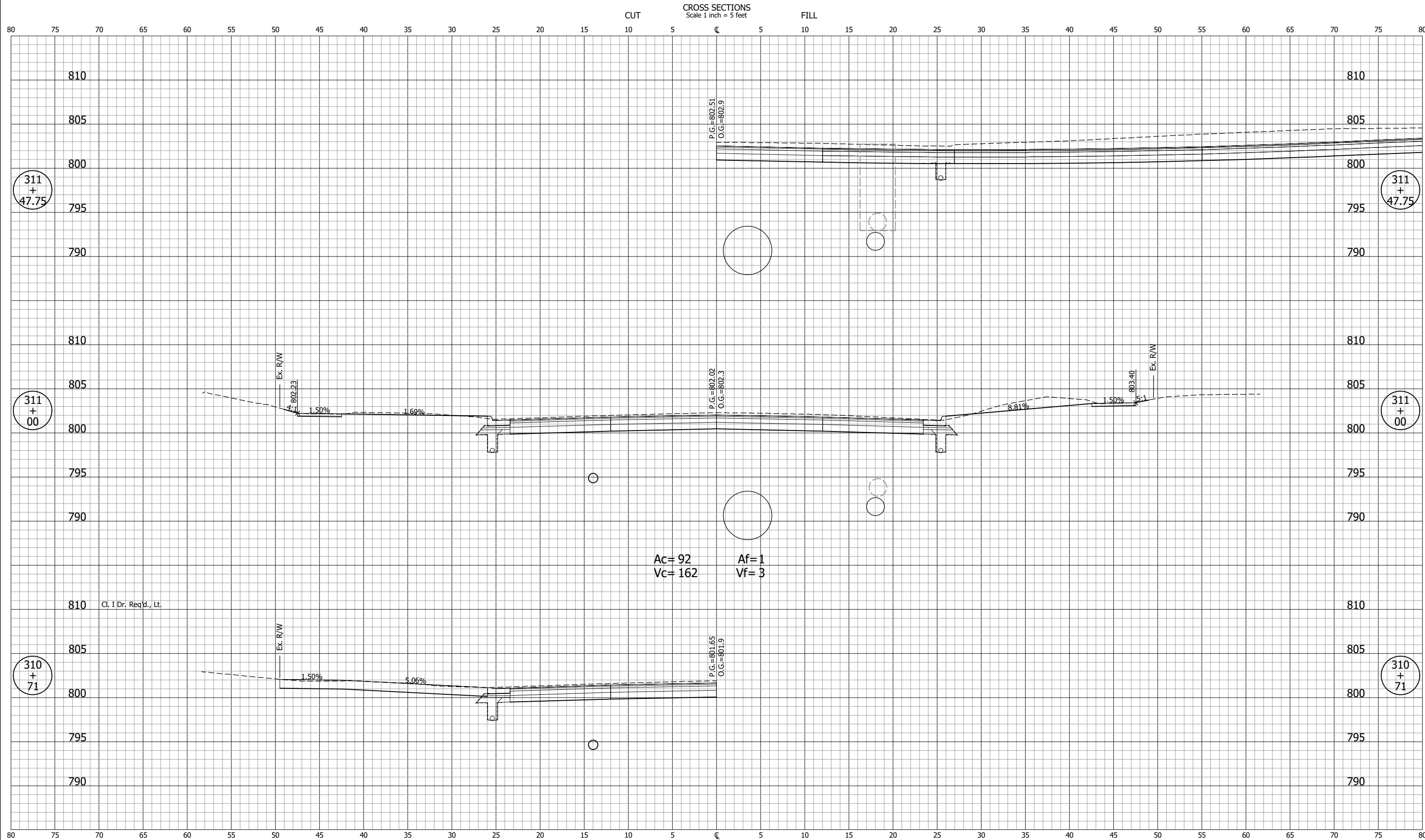

NOT FOR CONSTRUCTION		INDIANA DEPARTMENT OF TRANSPORTATION		SCALE 1" = 5'	BRIDGE FILE
		CROSS SECTIONS LINE "B"		DESIGNATION 2001885 & 2101797	
DESIGNED: DGA	DRAWN: GDH			SURVEY BOOK	SHEETS 302 of 357
CHECKED: DGD	CHECKED: DGA	CONTRACT R-43382	PROJECT 2001885		

GDH - 2/9/2024 12:27 PM - U:\2021\202124 indot us35\Cad\C30\Design Files\212440D_CO1.dwg (XS_28_B)

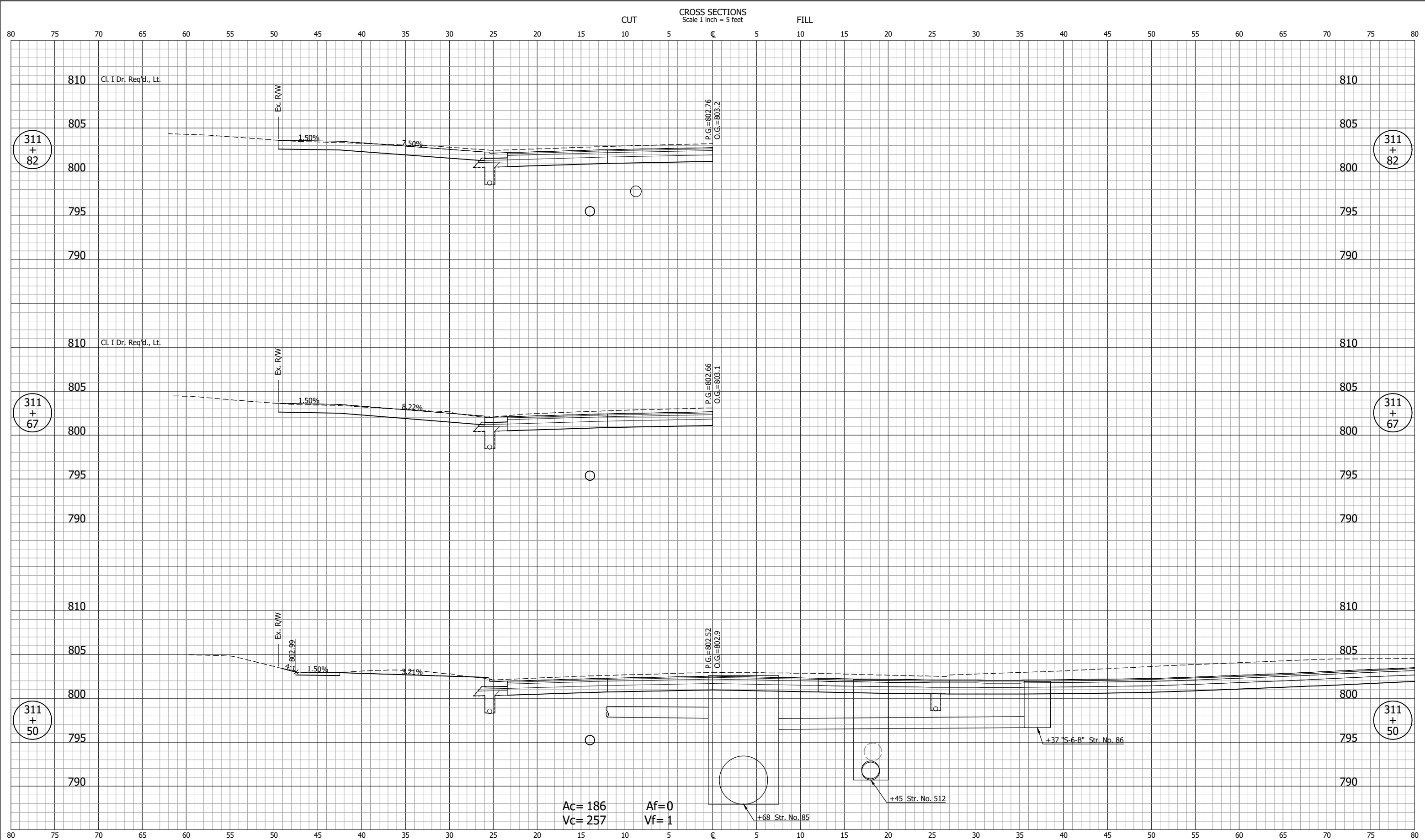

NOT FOR CONSTRUCTION		INDIANA DEPARTMENT OF TRANSPORTATION		SCALE 1" = 5'	BRIDGE FILE
		CROSS SECTIONS LINE "B"		DESIGNATION 2001885 & 2101797	
DESIGNED: DGA	DRAWN: GDH			SURVEY BOOK	SHEETS 303 of 357
CHECKED: DGD	CHECKED: DGA			CONTRACT R-43382	PROJECT 2001885

GDH - 2/9/2024 12:27 PM - U:\2021\202124.indot.us35\Cad\C30\Design Files\212440D_CO1.dwg (XS_29_B)

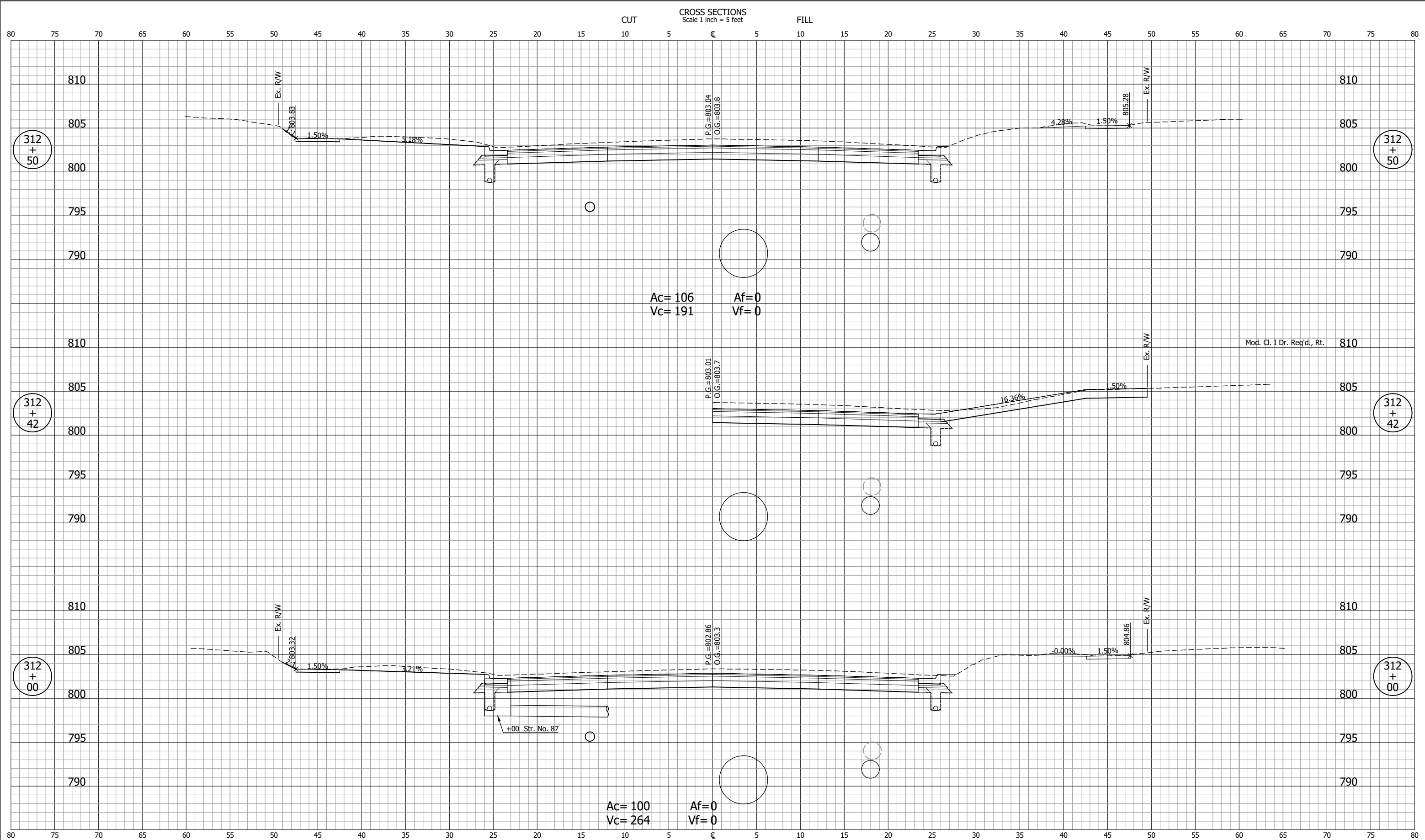

NOT FOR CONSTRUCTION		INDIANA DEPARTMENT OF TRANSPORTATION		SCALE 1" = 5'	BRIDGE FILE
DESIGNED: DGA		DRAWN: GDH		DESIGNATION 2001885 & 2101797	
CHECKED: DGD		CHECKED: DGA		SURVEY BOOK	SHEETS 304 of 357
		CROSS SECTIONS LINE "B"		CONTRACT R-43382	PROJECT 2001885

GDH - 2/9/2024 12:28 PM - U:\2021\202124 indot us35\Cad\C30\Design Files\212440D_CO1.dwg (XS_32_B)

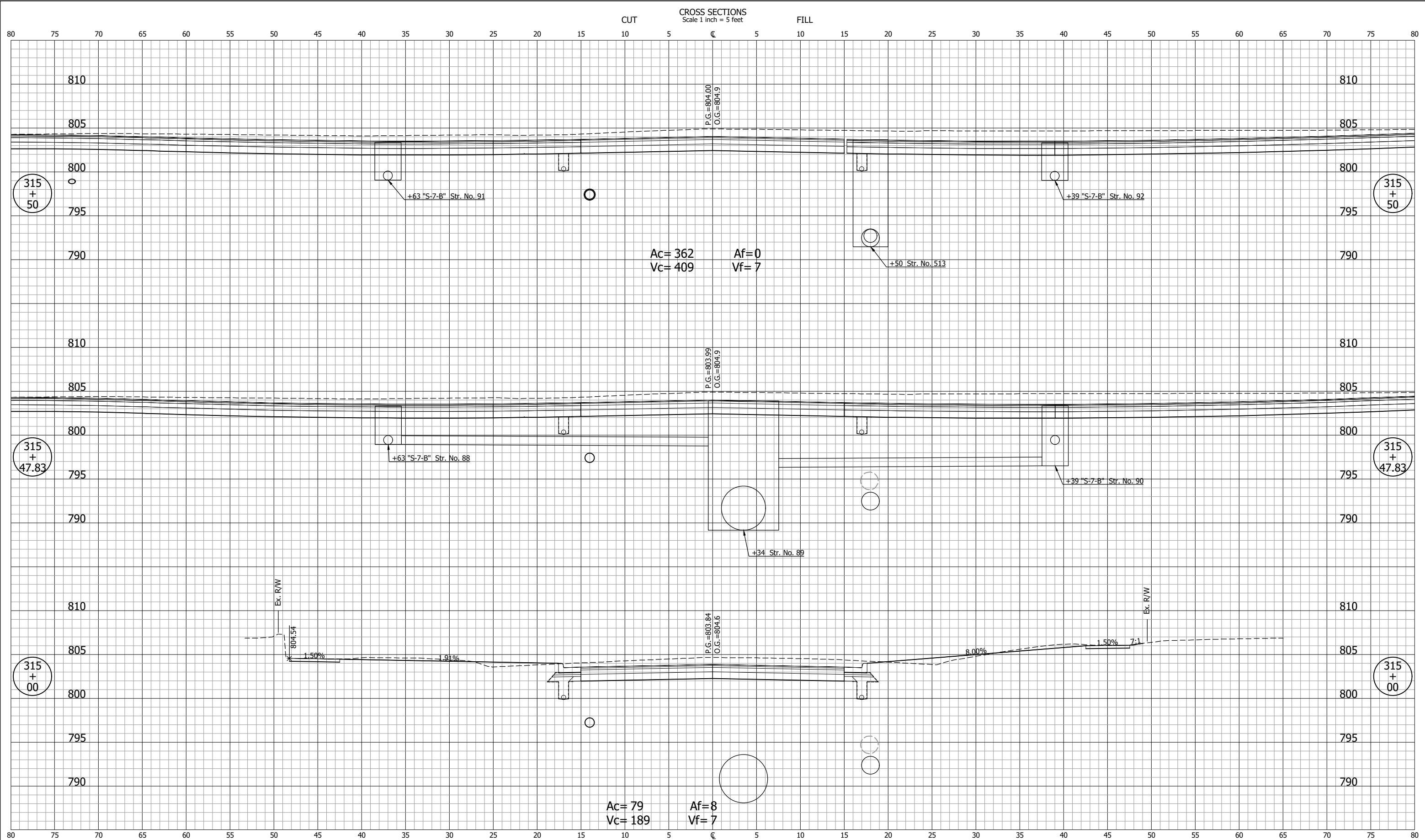

NOT FOR CONSTRUCTION		INDIANA DEPARTMENT OF TRANSPORTATION		SCALE 1" = 5'	BRIDGE FILE
DESIGNED: DGA		DRAWN: GDH		DESIGNATION 2001885 & 2101797	
CHECKED: DGD		CHECKED: DGA		SURVEY BOOK	SHEETS 307 of 357
CROSS SECTIONS LINE "B"				CONTRACT R-43382	PROJECT 2001885

GDH - 2/9/2024 12:28 PM - U:\2021\202124 indot us35\Cad\C30\Design Files\212440D_CO1.dwg (XS_33_B)

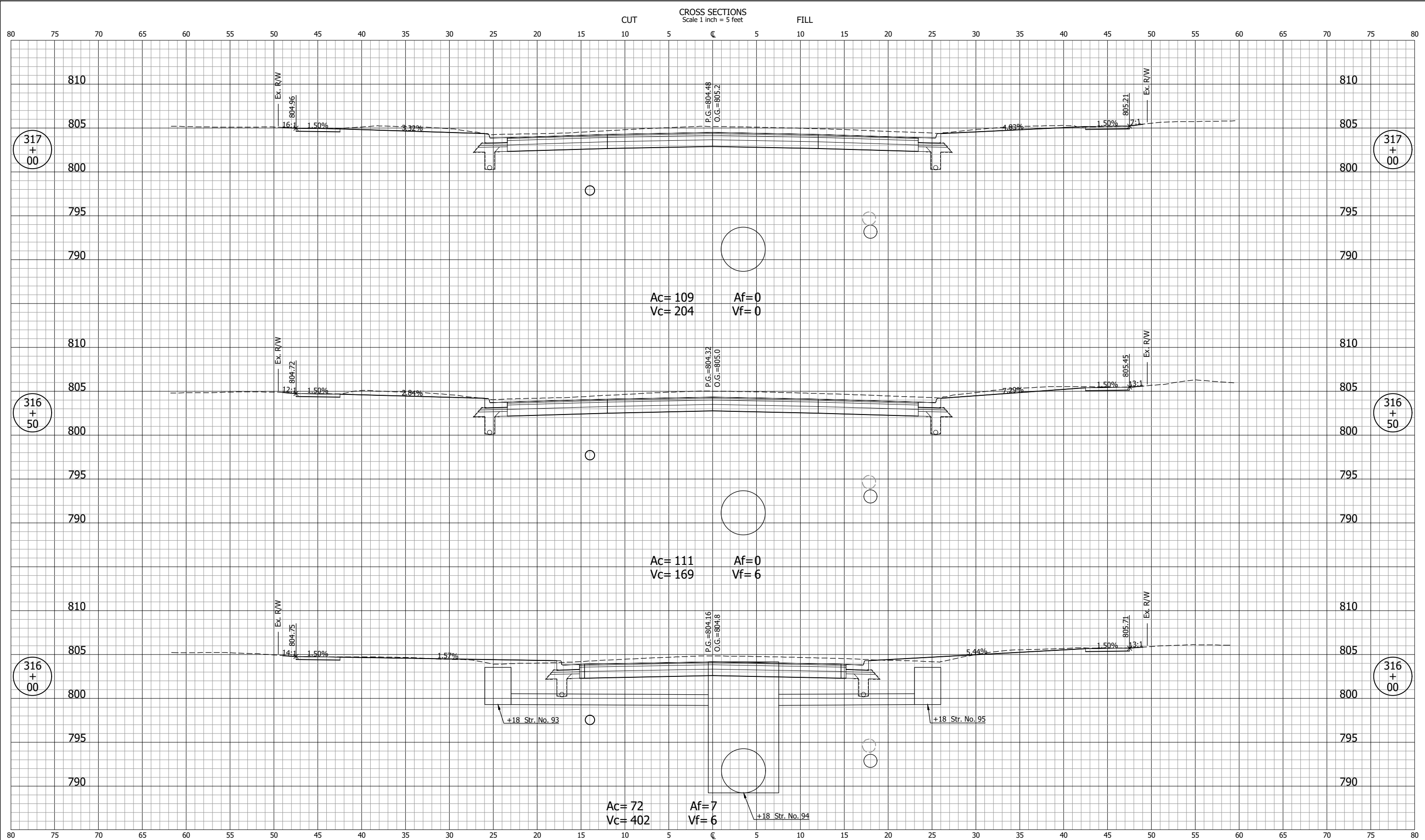

NOT FOR CONSTRUCTION		INDIANA DEPARTMENT OF TRANSPORTATION		SCALE 1" = 5'	BRIDGE FILE
		CROSS SECTIONS LINE "B"		DESIGNATION 2001885 & 2101797	
DESIGNED: DGA	DRAWN: GDH			SURVEY BOOK	SHEETS
CHECKED: DGD	CHECKED: DGA			CONTRACT R-43382	308 of 357 PROJECT 2001885

CROSS SECTIONS
Scale 1 inch = 5 feet

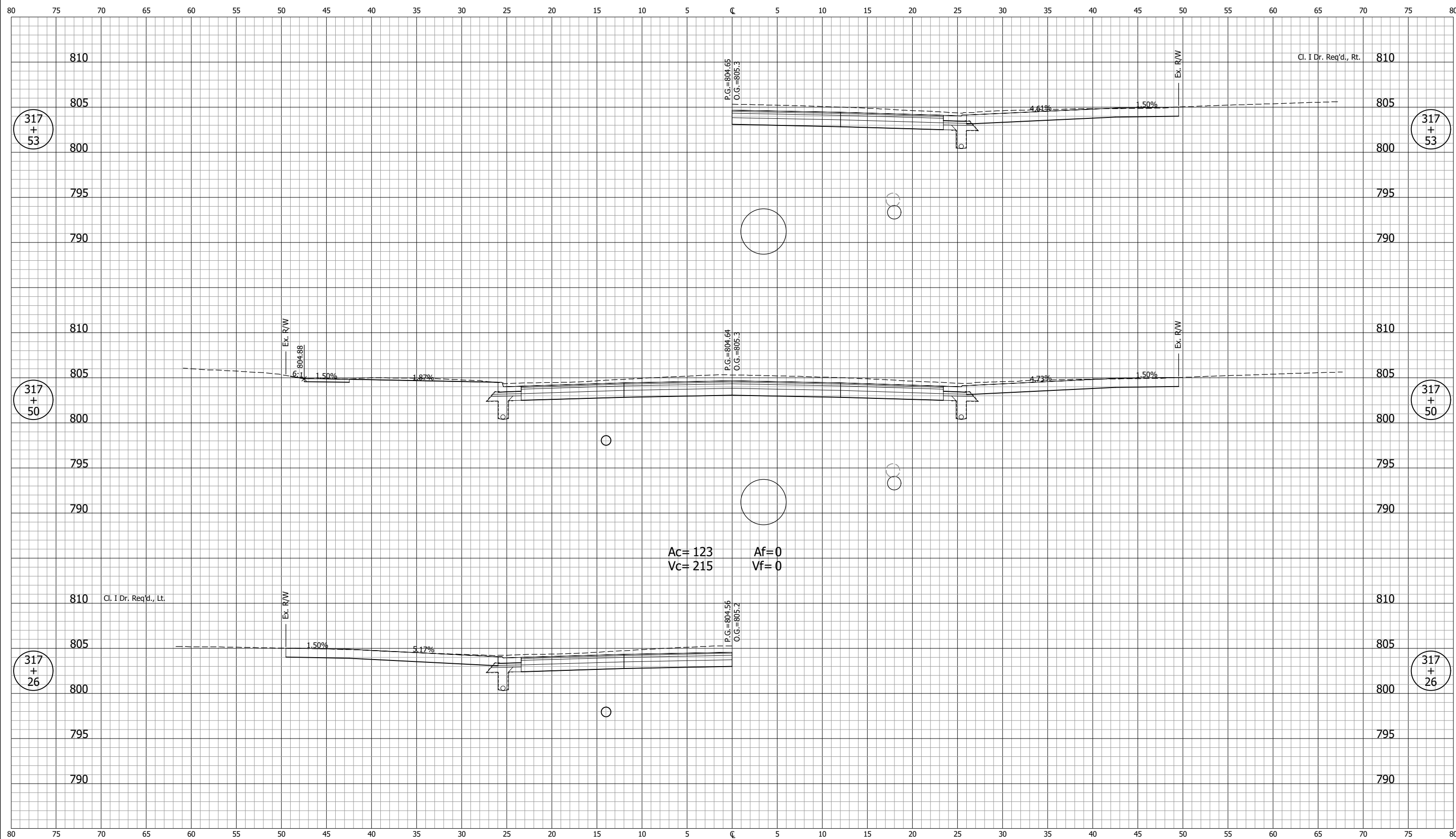

Ac= 123 Af=0
Vc= 215 Vf= 0

GDH - 2/9/2024 12:28 PM - U:\2021\202124 indot us35\Cad\C30\Design Files\212440D_CO1.dwg (XS_34_B)

NOT FOR CONSTRUCTION		INDIANA DEPARTMENT OF TRANSPORTATION		SCALE 1" = 5'	BRIDGE FILE
		CROSS SECTIONS LINE "B"		DESIGNATION 2001885 & 2101797	
SURVEY BOOK	SHEETS 309 of 357				
CONTRACT R-43382	PROJECT 2001885				

CROSS SECTIONS
Scale 1 inch = 5 feet

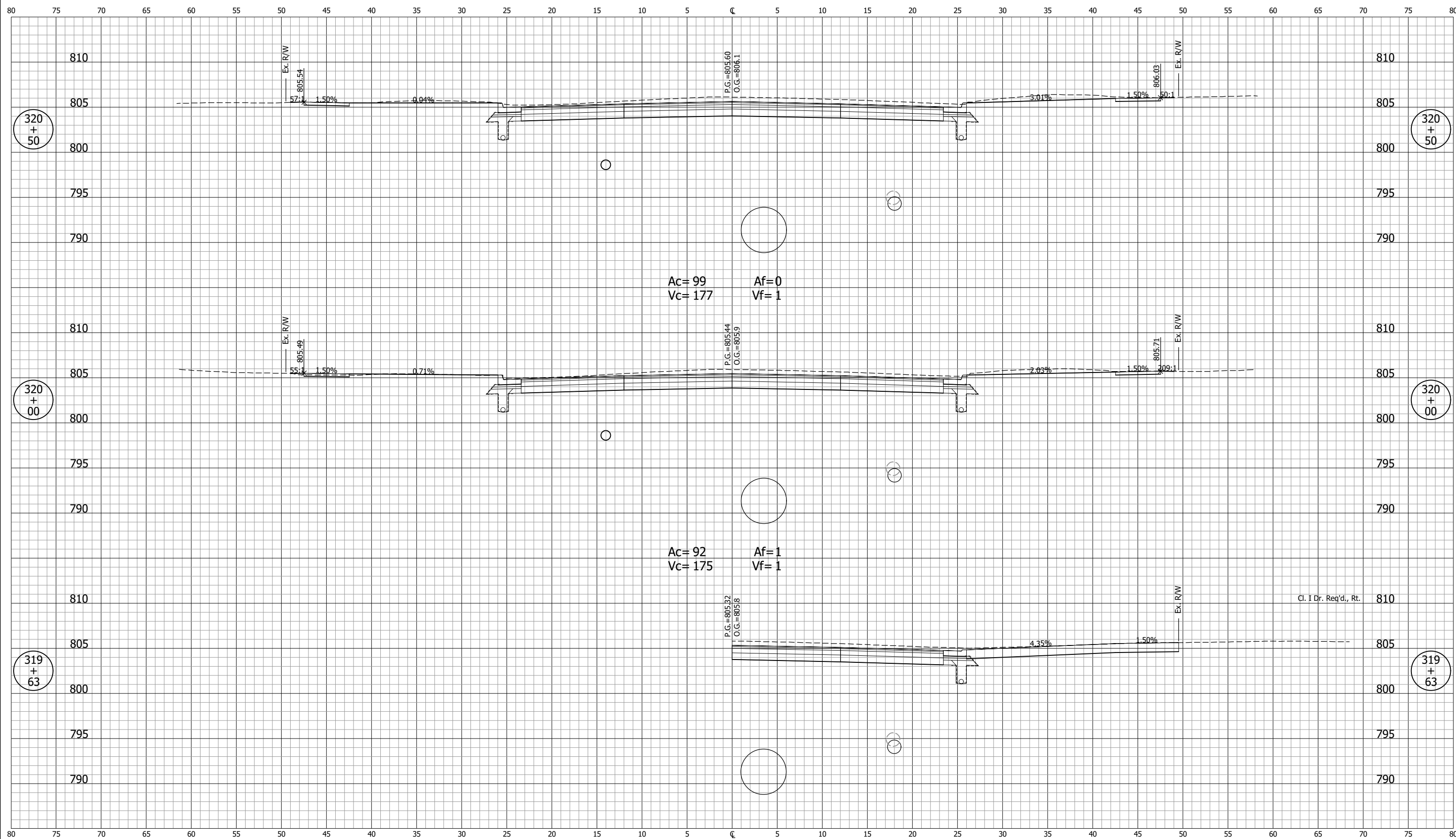

GDH - 2/9/2024 12:28 PM - U:\2021\202124 indot us35\Cad\C30\Design Files\212440D_CO1.dwg (XS_37_B)

NOT FOR CONSTRUCTION		INDIANA DEPARTMENT OF TRANSPORTATION		SCALE 1" = 5'	BRIDGE FILE
		CROSS SECTIONS LINE "B"		DESIGNATION 2001885 & 2101797	
SURVEY BOOK	SHEETS 312 of 357				
CONTRACT R-43382	PROJECT 2001885				

GDH - 2/9/2024 12:28 PM - U:\2021\202124.indot.us35\Cad\C30\Design Files\212440_CO1.dwg (XS_39_B)

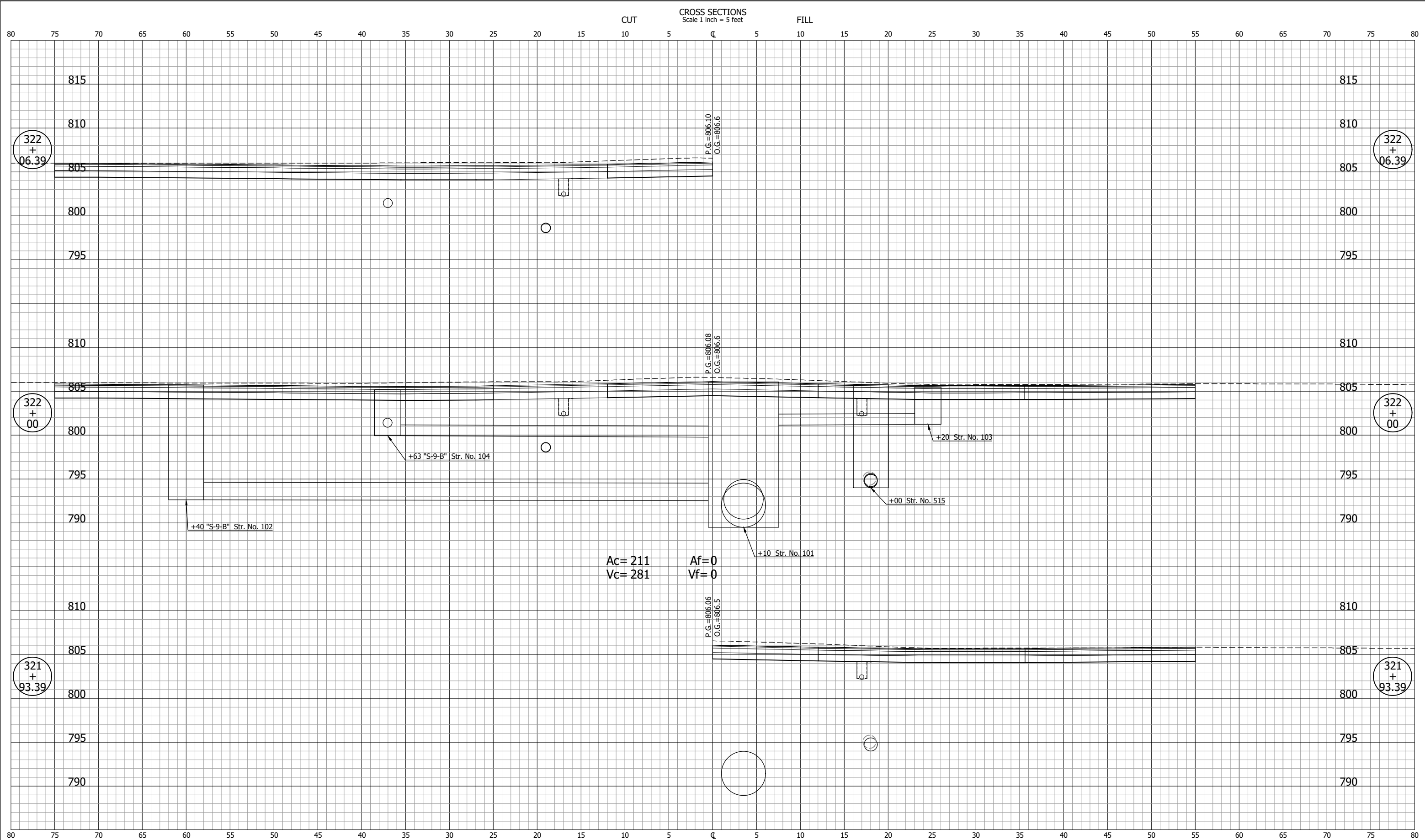

Ac= 211
Vc= 281
Af= 0
Vf= 0

NOT FOR CONSTRUCTION		INDIANA DEPARTMENT OF TRANSPORTATION		SCALE 1" = 5'	BRIDGE FILE
		CROSS SECTIONS LINE "B"		DESIGNATION 2001885 & 2101797	
SURVEY BOOK	SHEETS 314 of 357				
CONTRACT R-43382	PROJECT 2001885				

GDH - 2/9/2024 12:29 PM - U:\2021\202124 indot us35\Cad\C30\Design Files\212440D_CO1.dwg (XS_43_B)

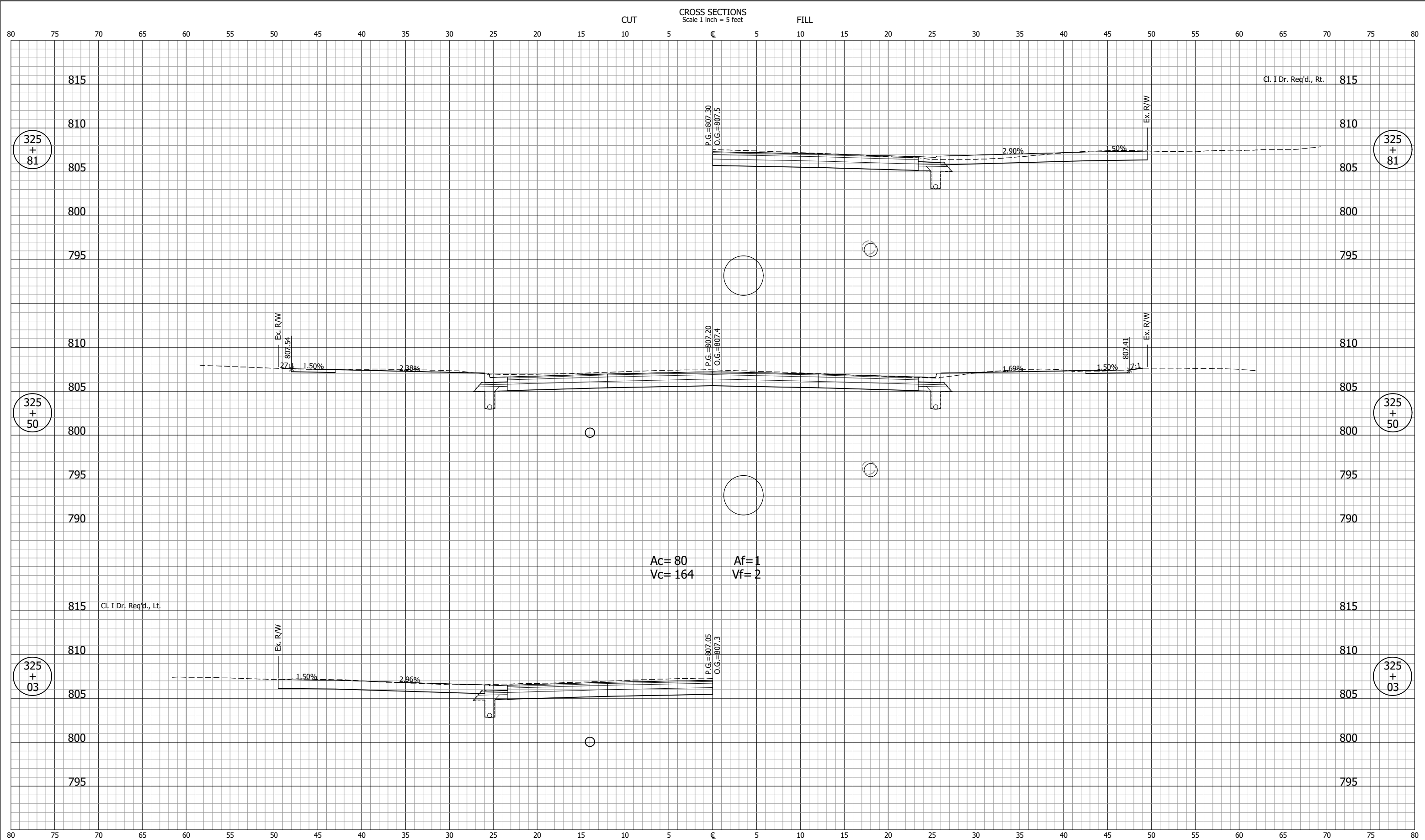

NOT FOR CONSTRUCTION		INDIANA DEPARTMENT OF TRANSPORTATION		SCALE 1" = 5'	BRIDGE FILE
DESIGNED: DGA		DRAWN: GDH		DESIGNATION 2001885 & 2101797	
CHECKED: DGD		CHECKED: DGA		SURVEY BOOK	SHEETS 318 of 357
		CROSS SECTIONS LINE "B"		CONTRACT R-43382	PROJECT 2001885

CROSS SECTIONS
Scale 1 inch = 5 feet

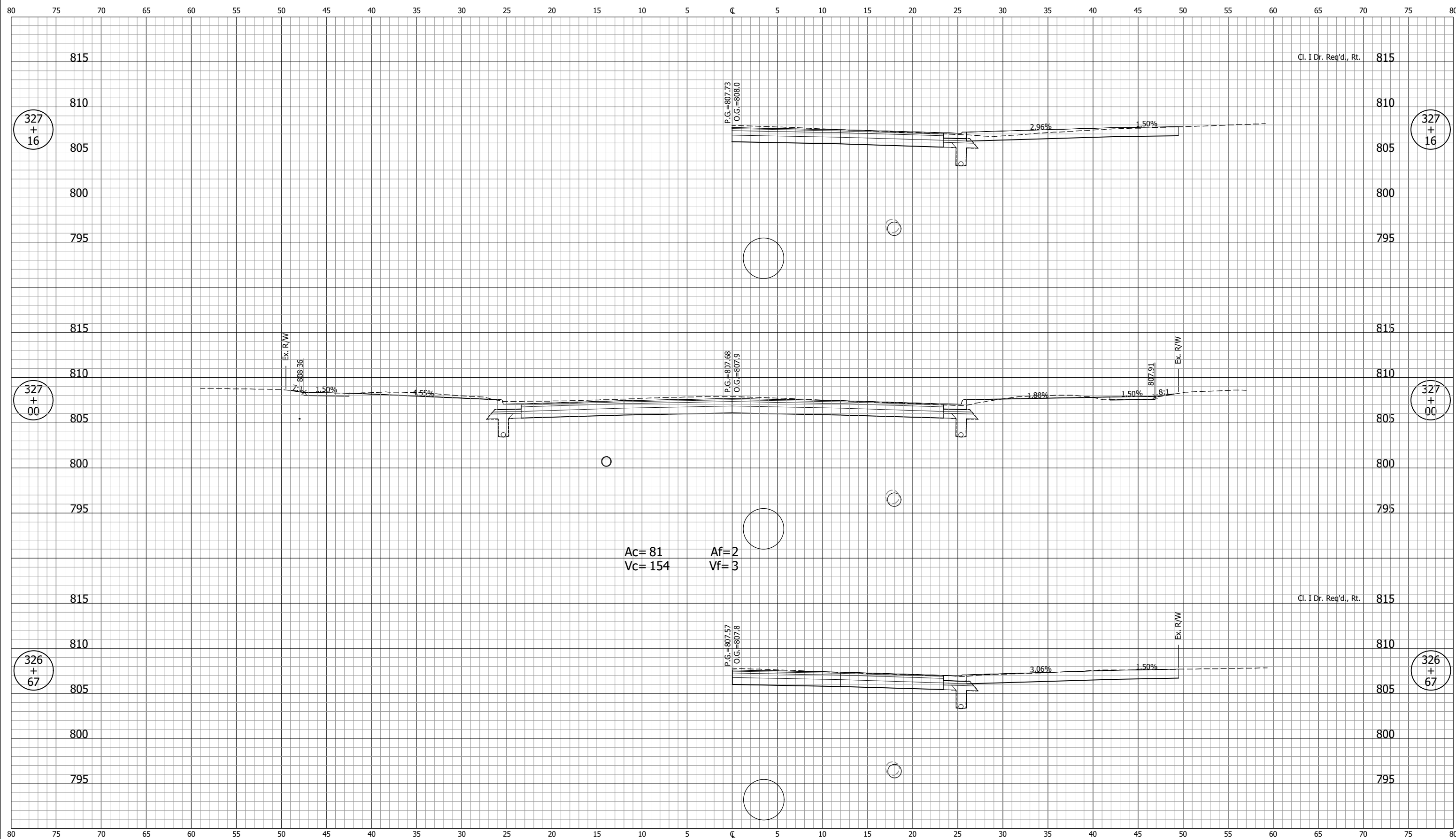

GDH - 2/9/2024 12:49 PM - U:\2021\202124 indot us35\Cad\C30\Design Files\212440D_C02.dwg (XS_45A_B)

NOT FOR CONSTRUCTION		INDIANA DEPARTMENT OF TRANSPORTATION		SCALE 1" = 5'	BRIDGE FILE
		CROSS SECTIONS LINE "B"		DESIGNATION 2001885 & 2101797	
SURVEY BOOK	SHEETS 320 of 357				
CONTRACT R-43382	PROJECT 2001885				

GDH - 2/9/2024 12:49 PM - U:\2021\202124.indot.us35\Cad\C30\Design Files\212440D_C02.dwg (XS_45_B)

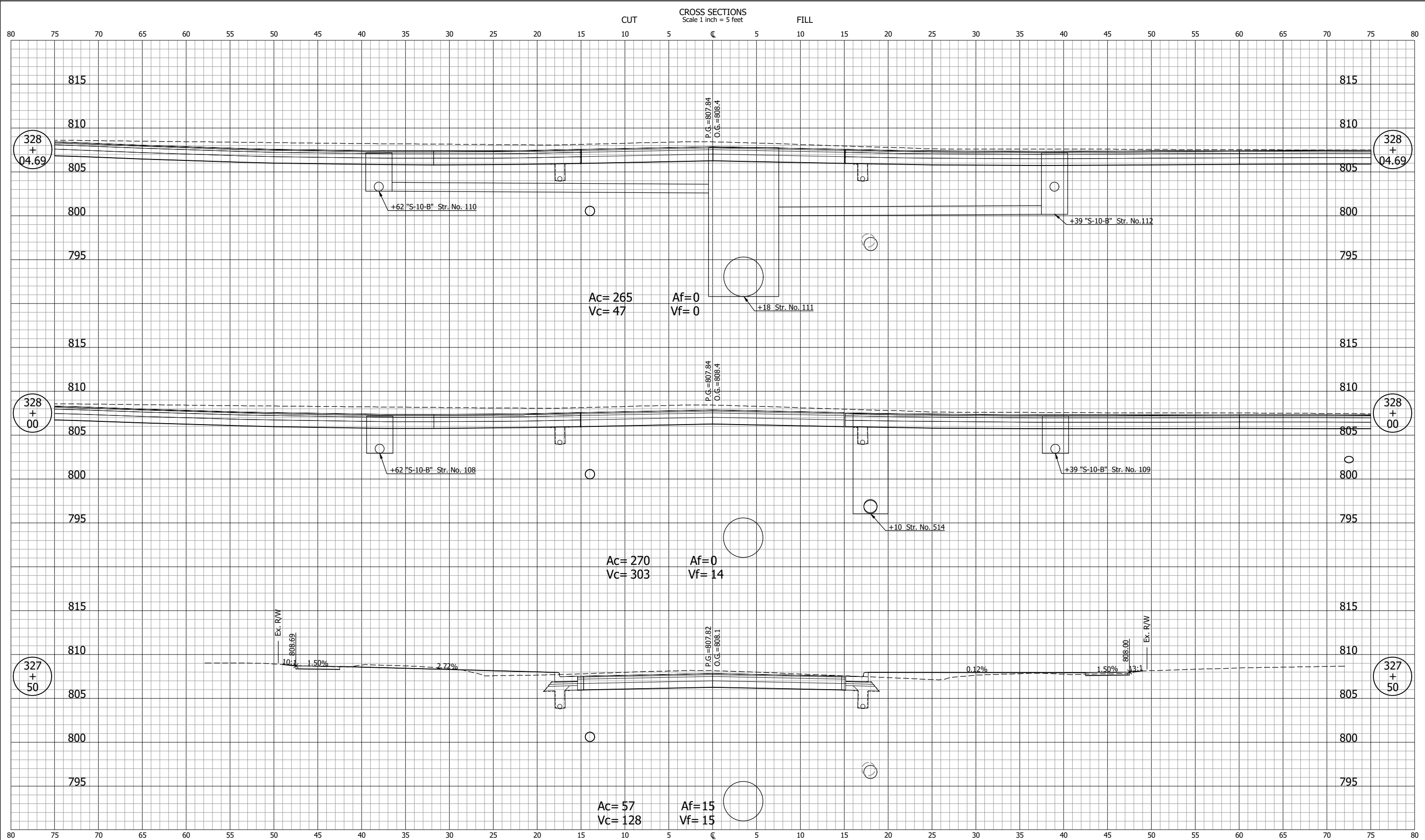

NOT FOR CONSTRUCTION		INDIANA DEPARTMENT OF TRANSPORTATION		SCALE 1" = 5'	BRIDGE FILE
		CROSS SECTIONS LINE "B"		DESIGNATION 2001885 & 2101797	
SURVEY BOOK	SHEETS 321 of 357				
CONTRACT R-43382	PROJECT 2001885				

GDH - 2/9/2024 12:49 PM - U:\2021\202124 indot us35\Cad\C30\Design Files\212440D_C02.dwg (XS_47_B)

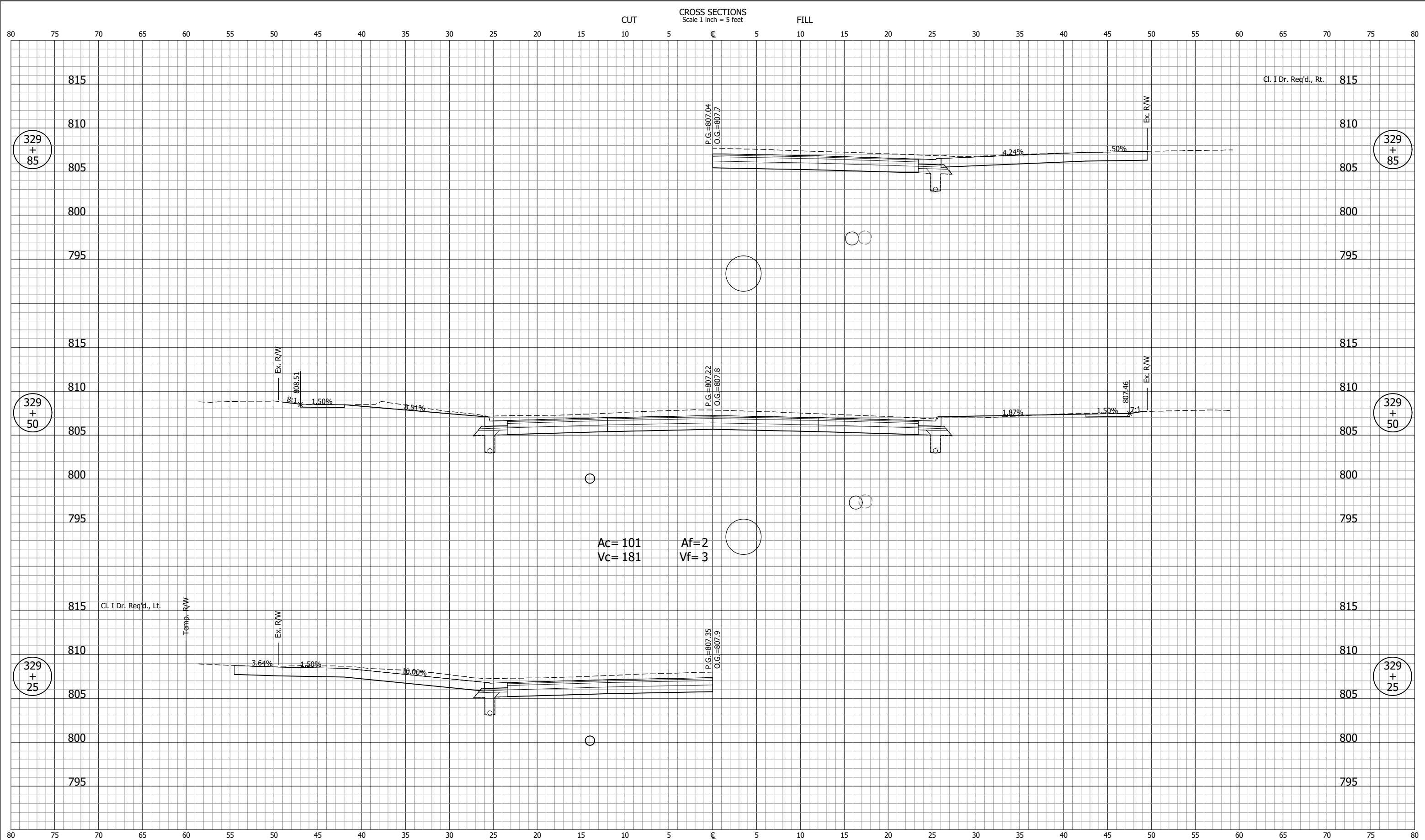

NOT FOR CONSTRUCTION		INDIANA DEPARTMENT OF TRANSPORTATION		SCALE 1" = 5'	BRIDGE FILE
		CROSS SECTIONS LINE "B"		DESIGNATION 2001885 & 2101797	
SURVEY BOOK	SHEETS 323 of 357				
CONTRACT R-43382	PROJECT 2001885				

GDH - 2/9/2024 12:49 PM - U:\2021\202124.indot.us35\Cad\C30\Design Files\212440D_C02.dwg (XS_4B_B)

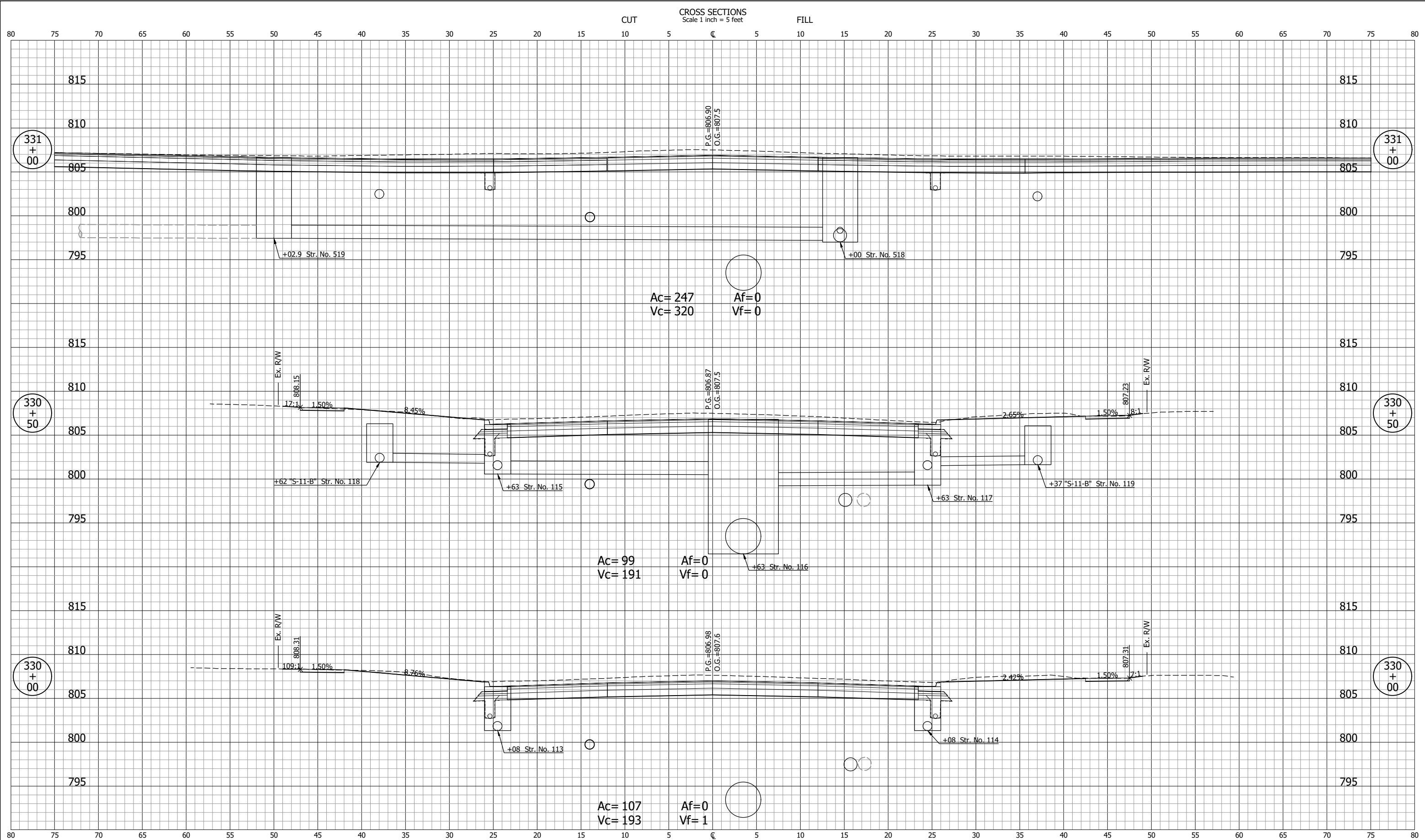

NOT FOR CONSTRUCTION		INDIANA DEPARTMENT OF TRANSPORTATION		SCALE 1" = 5'	BRIDGE FILE
		CROSS SECTIONS LINE "B"		DESIGNATION 2001885 & 2101797	
DESIGNED: DGA	DRAWN: GDH			SURVEY BOOK	SHEETS 324 of 357
CHECKED: DGD	CHECKED: DGA			CONTRACT R-43382	PROJECT 2001885

GDH - 2/9/2024 12:49 PM - U:\2021\202124.indot.us35\Cad\C30\Design Files\212440_C02.dwg (XS_49_B)

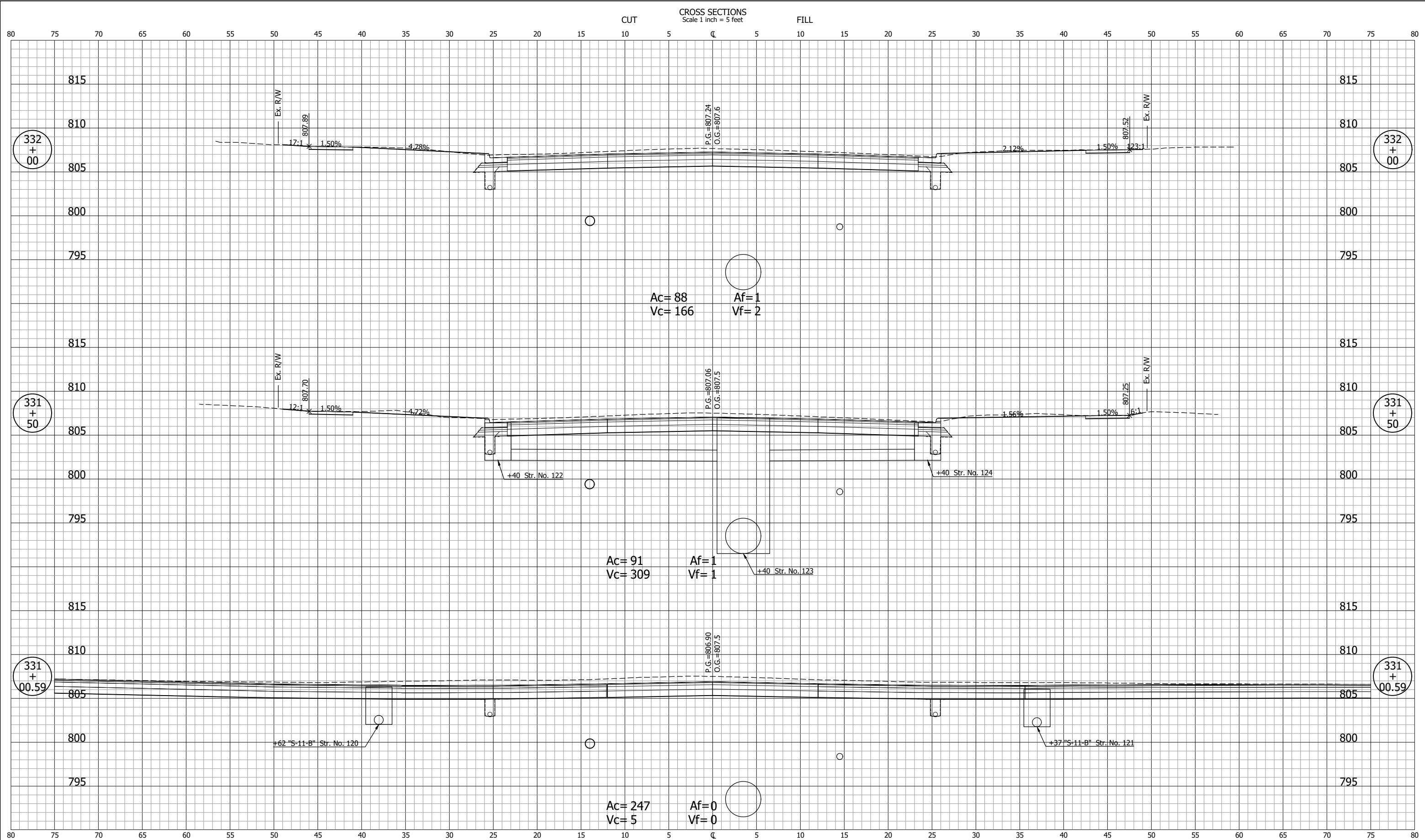

NOT FOR CONSTRUCTION		INDIANA DEPARTMENT OF TRANSPORTATION		SCALE 1" = 5'	BRIDGE FILE
		CROSS SECTIONS LINE "B"		DESIGNATION 2001885 & 2101797	
DESIGNED: DGA	DRAWN: GDH			SURVEY BOOK	SHEETS
CHECKED: DGD	CHECKED: DGA			CONTRACT R-43382	325 of 357 PROJECT 2001885

GDH - 2/9/2024 12:49 PM - U:\2021\202124.indot.us35\Cad\C30\Design Files\212440D_C02.dwg (XS_51_B)

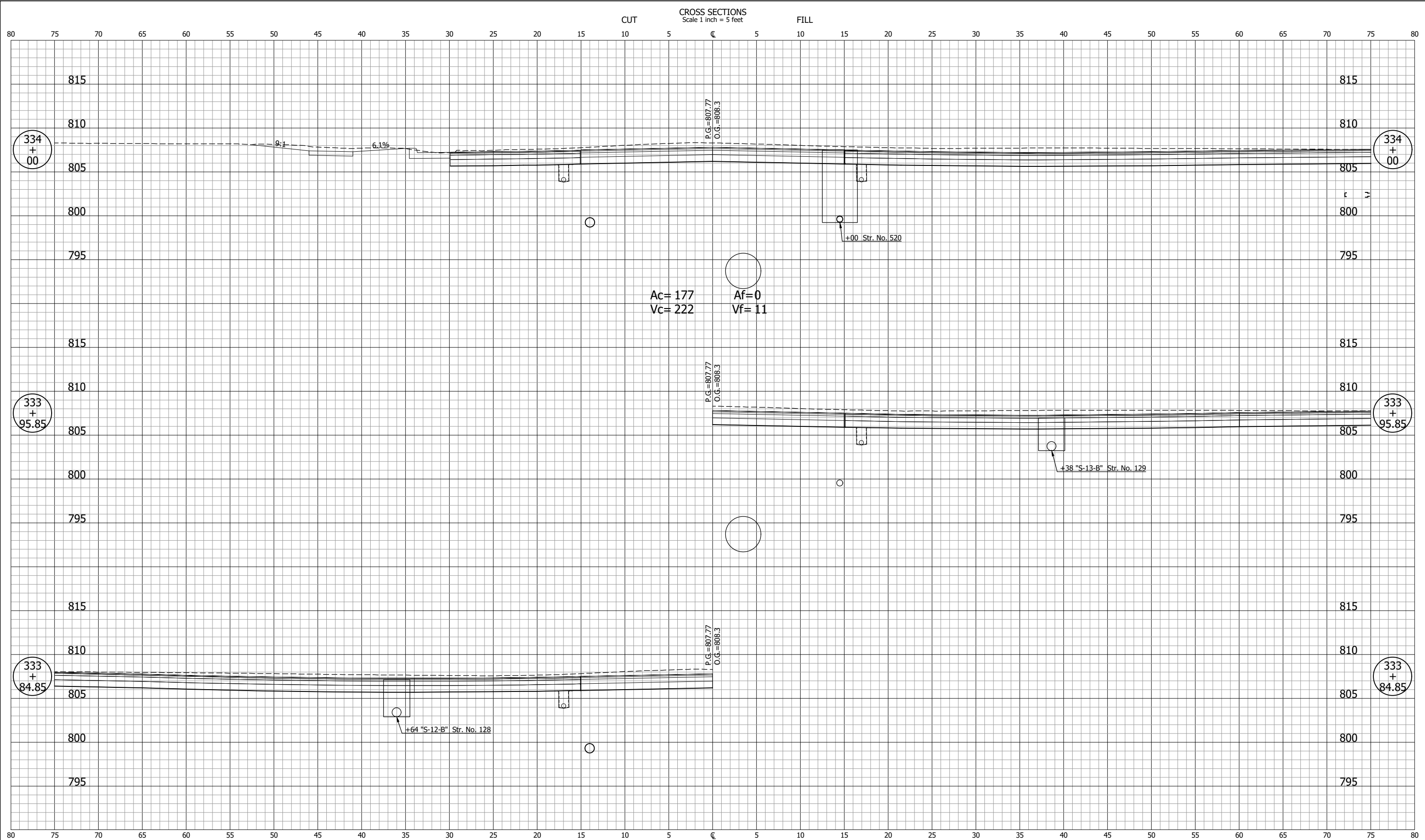

NOT FOR CONSTRUCTION		INDIANA DEPARTMENT OF TRANSPORTATION		SCALE 1" = 5'	BRIDGE FILE
		CROSS SECTIONS LINE "B"		DESIGNATION 2001885 & 2101797	
SURVEY BOOK	SHEETS 327 of 357				
CONTRACT R-43382	PROJECT 2001885				

GDH - 2/9/2024 12:49 PM - U:\2021\202124 indot us35\Cad\C30\Design Files\212440D_C02.dwg (XS_52_B)

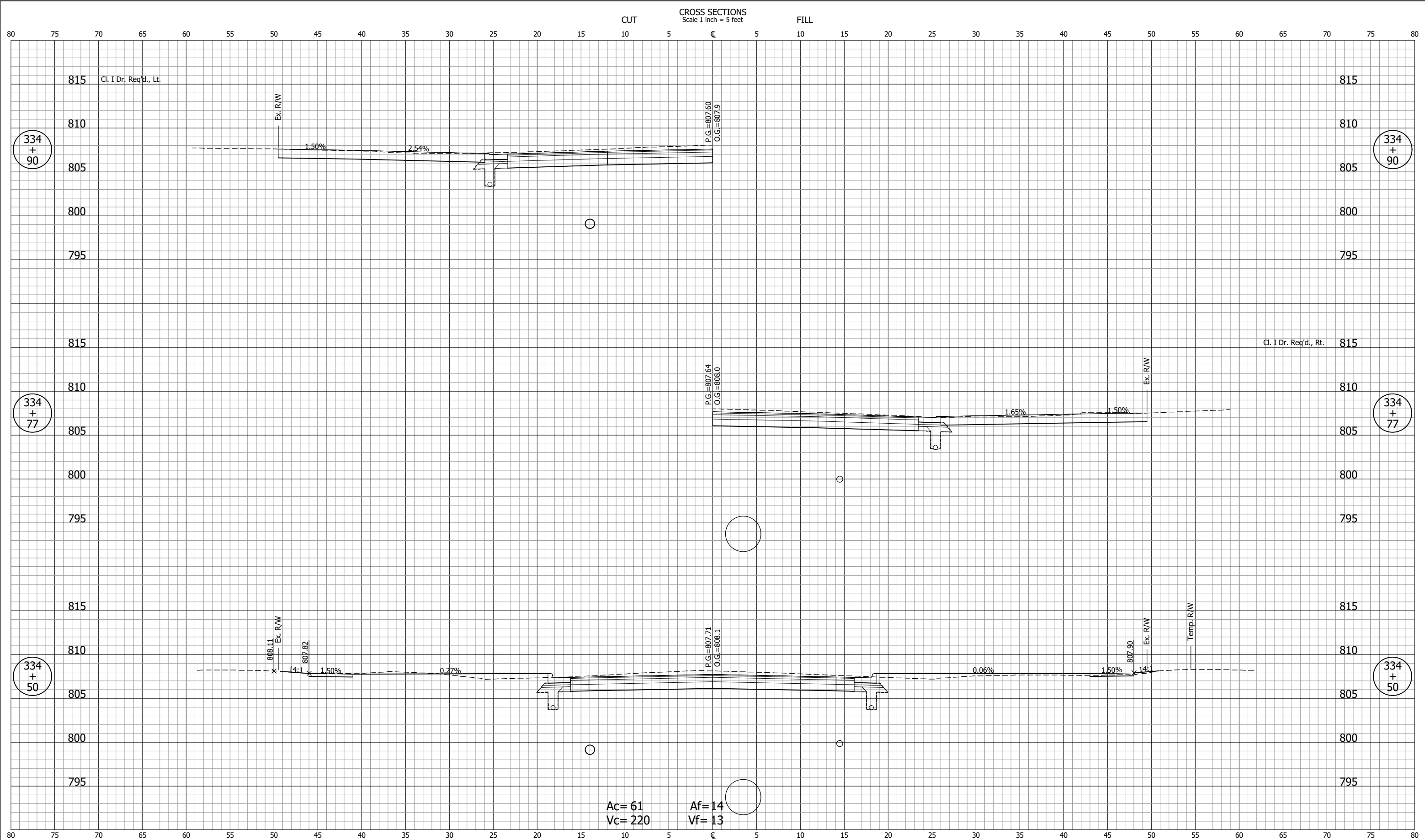

Ac=61
Vc=220
Af=14
Vf=13

NOT FOR CONSTRUCTION		INDIANA DEPARTMENT OF TRANSPORTATION		SCALE 1" = 5'	BRIDGE FILE
DESIGNED: DGA		DRAWN: GDH		DESIGNATION 2001885 & 2101797	
CHECKED: DGD		CHECKED: DGA		SURVEY BOOK	SHEETS 328 of 357
		CROSS SECTIONS LINE "B"		CONTRACT R-43382	PROJECT 2001885

GDH - 2/9/2024 12:50 PM - U:\2021\202124 indot us35\Cad\C30\Design Files\212440D_C02.dwg (XS_53_B)

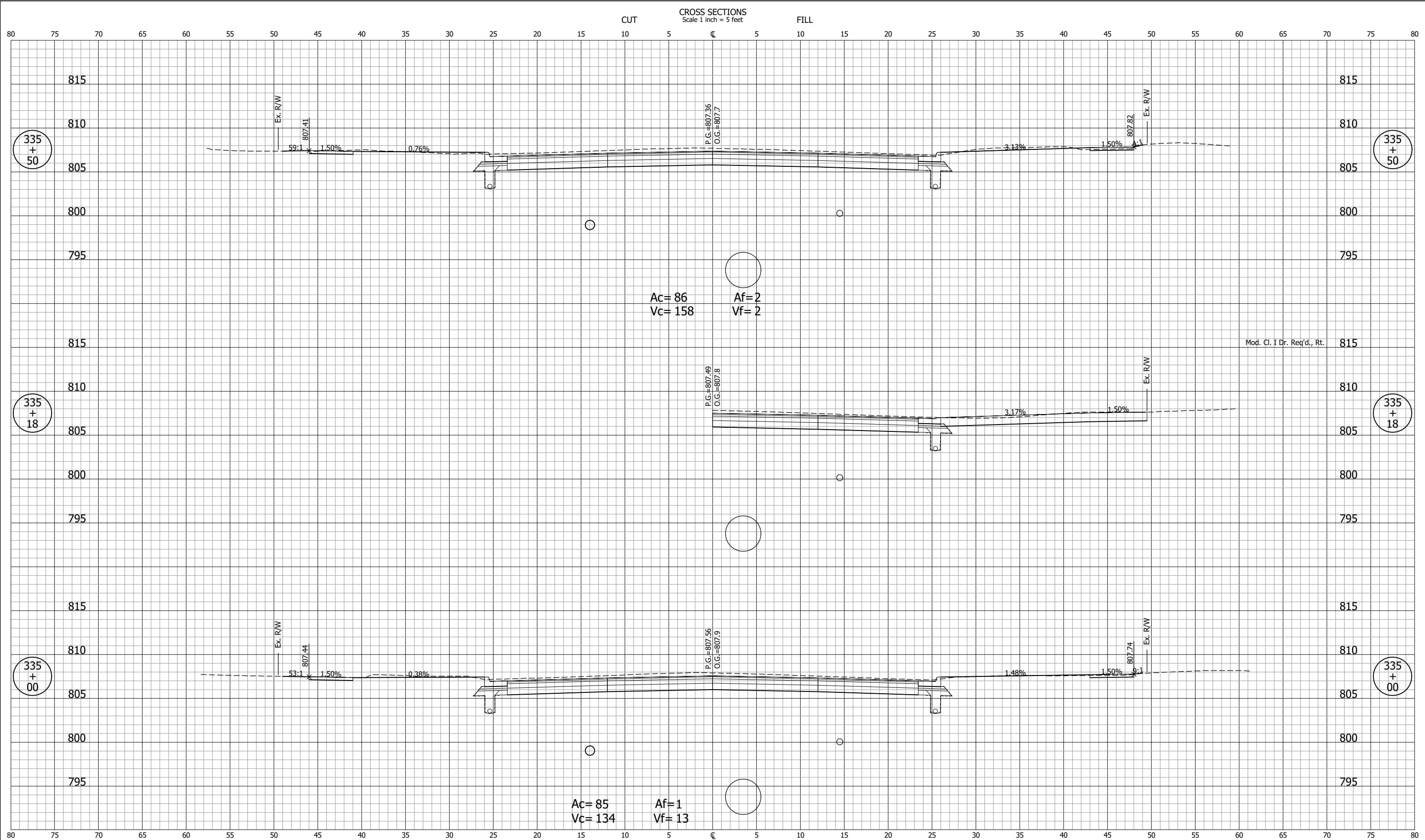

NOT FOR CONSTRUCTION

DESIGNED: DGA	DRAWN: GDH
CHECKED: DGD	CHECKED: DGA

**INDIANA
DEPARTMENT OF TRANSPORTATION**

**CROSS SECTIONS
LINE "B"**

SCALE 1" = 5'	BRIDGE FILE
	DESIGNATION 2001885 & 2101797
SURVEY BOOK	SHEETS 329 of 357
CONTRACT R-43382	PROJECT 2001885

GDH - 2/9/2024 12:50 PM - U:\2021\202124 indot us35\Cad\C30\Design Files\212440D_C02.dwg (XS_54_B)

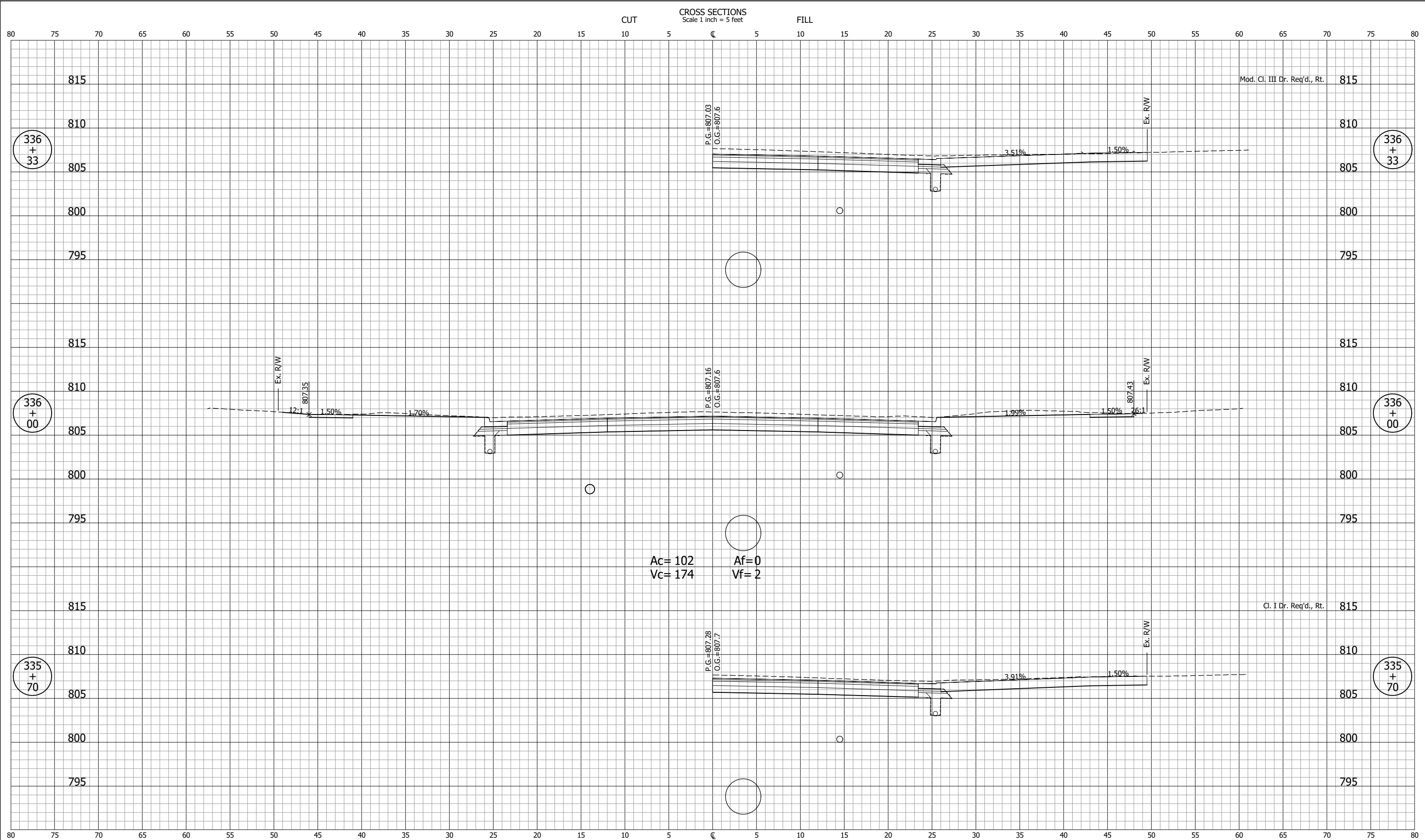

NOT FOR CONSTRUCTION		INDIANA DEPARTMENT OF TRANSPORTATION		SCALE 1" = 5'	BRIDGE FILE
DESIGNED: DGA		DRAWN: GDH		DESIGNATION 2001885 & 2101797	
CHECKED: DGD		CHECKED: DGA		SURVEY BOOK	SHEETS 330 of 357
		CROSS SECTIONS LINE "B"		CONTRACT R-43382	PROJECT 2001885

CROSS SECTIONS
Scale 1 inch = 5 feet

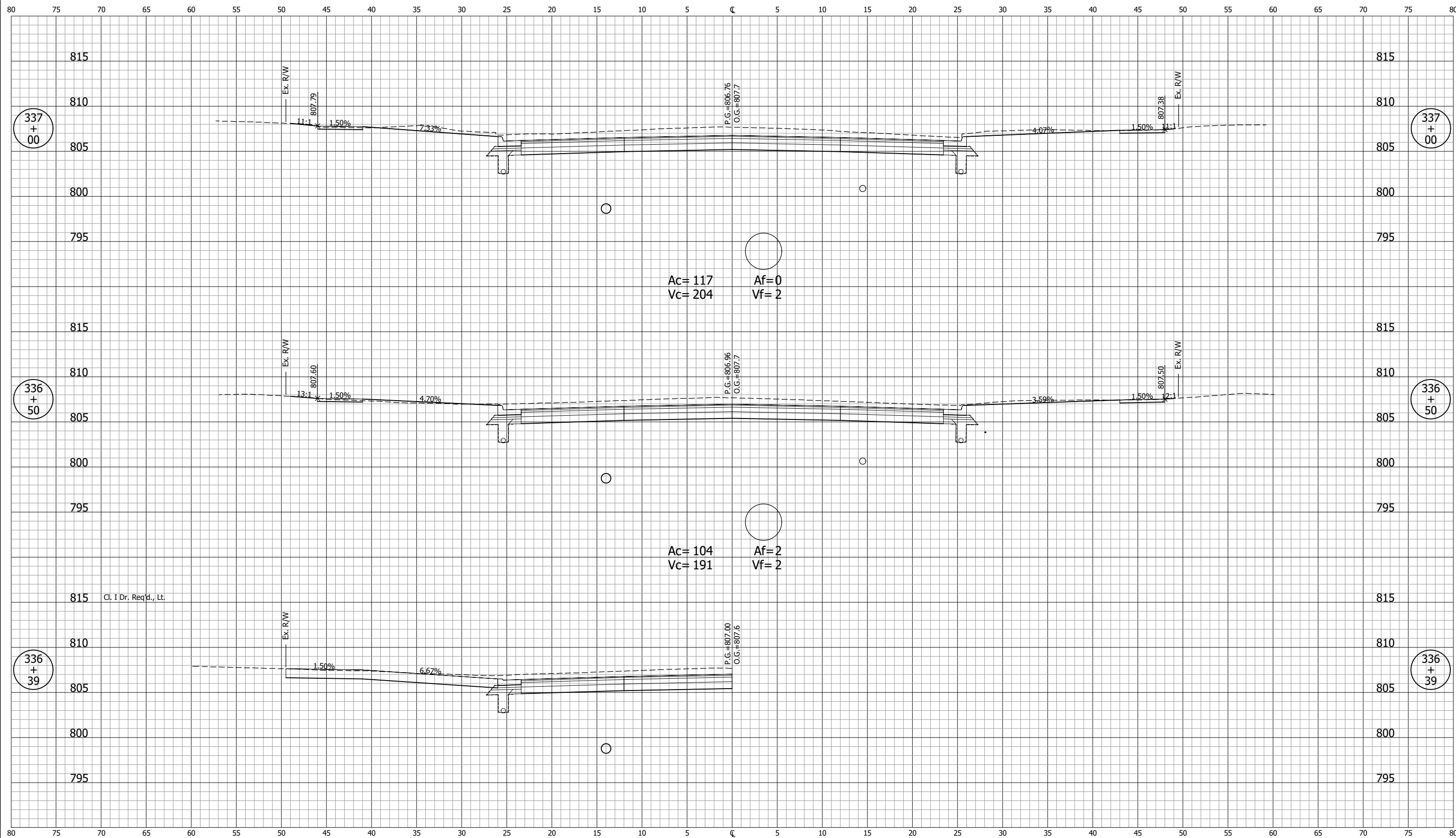

Ac= 117
Vc= 204
Af= 0
Vf= 2

Ac= 104
Vc= 191
Af= 2
Vf= 2

Cl. I Dr. Req'd., Lt.

NOT FOR CONSTRUCTION		INDIANA DEPARTMENT OF TRANSPORTATION		SCALE 1" = 5'	BRIDGE FILE
		CROSS SECTIONS LINE "B"		DESIGNATION 2001885 & 2101797	
SURVEY BOOK	SHEETS				
CONTRACT R-43382	331 of 357 PROJECT 2001885				

GDH - 2/9/2024 12:50 PM - U:\2021\202124 indot us35\Cad\C30\Design Files\212440D_C02.dwg (XS_55_B)

GDH - 2/9/2024 12:50 PM - U:\2021\202124.indot.us35\Cad\C30\Design Files\212440D_C02.dwg (XS_56_B)

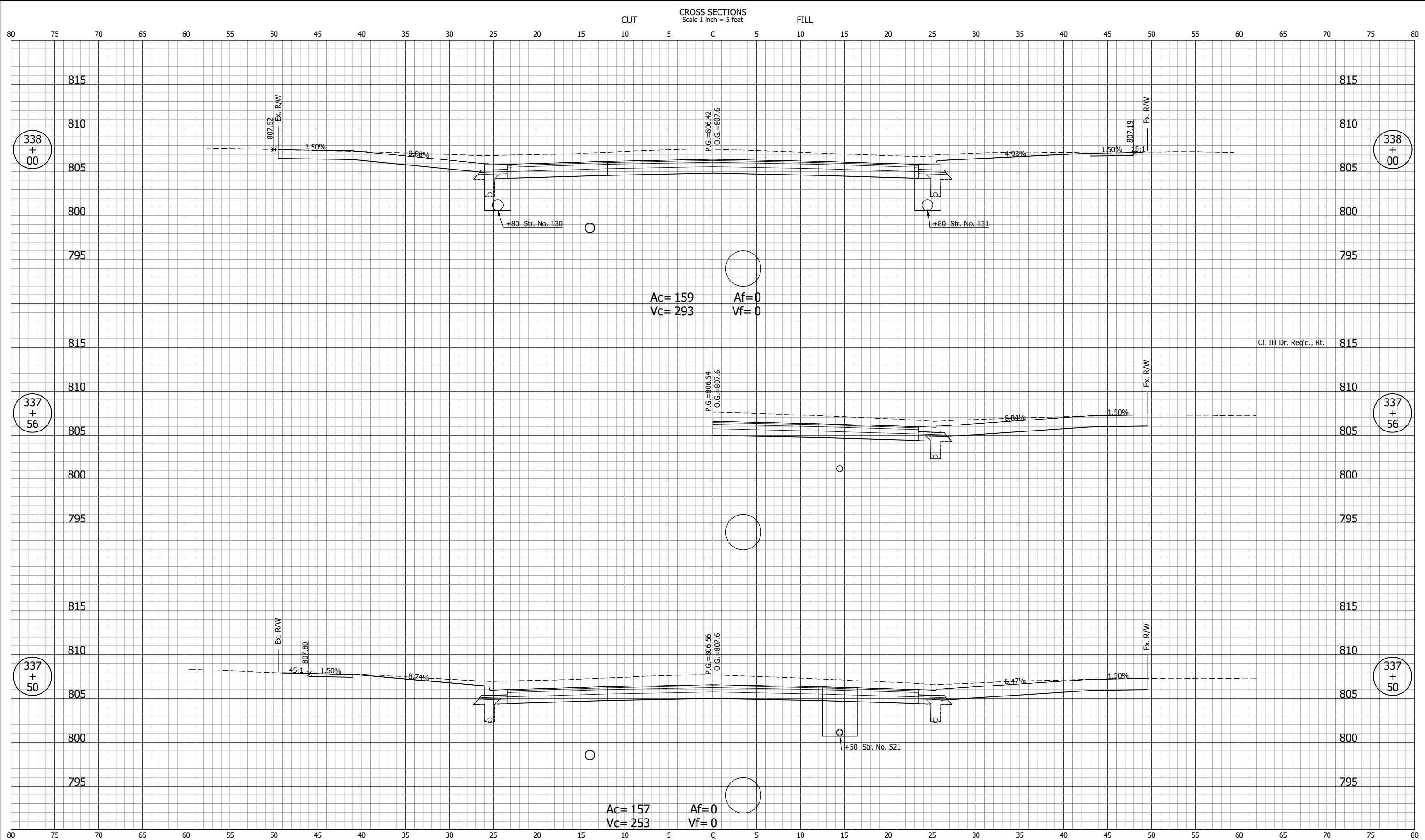

Ac= 159
Vc= 293
Af= 0
Vf= 0

Ac= 157
Vc= 253
Af= 0
Vf= 0

NOT FOR CONSTRUCTION

DESIGNED: DGA	DRAWN: GDH
CHECKED: DGD	CHECKED: DGA

**INDIANA
DEPARTMENT OF TRANSPORTATION**

**CROSS SECTIONS
LINE "B"**

SCALE 1" = 5'	BRIDGE FILE
	DESIGNATION 2001885 & 2101797
SURVEY BOOK	SHEETS 332 of 357
CONTRACT R-43382	PROJECT 2001885

GDH - 2/9/2024 12:50 PM - U:\2021\202124 indot us35\Cad\C30\Design Files\212440D_C02.dwg (XS_57_B)

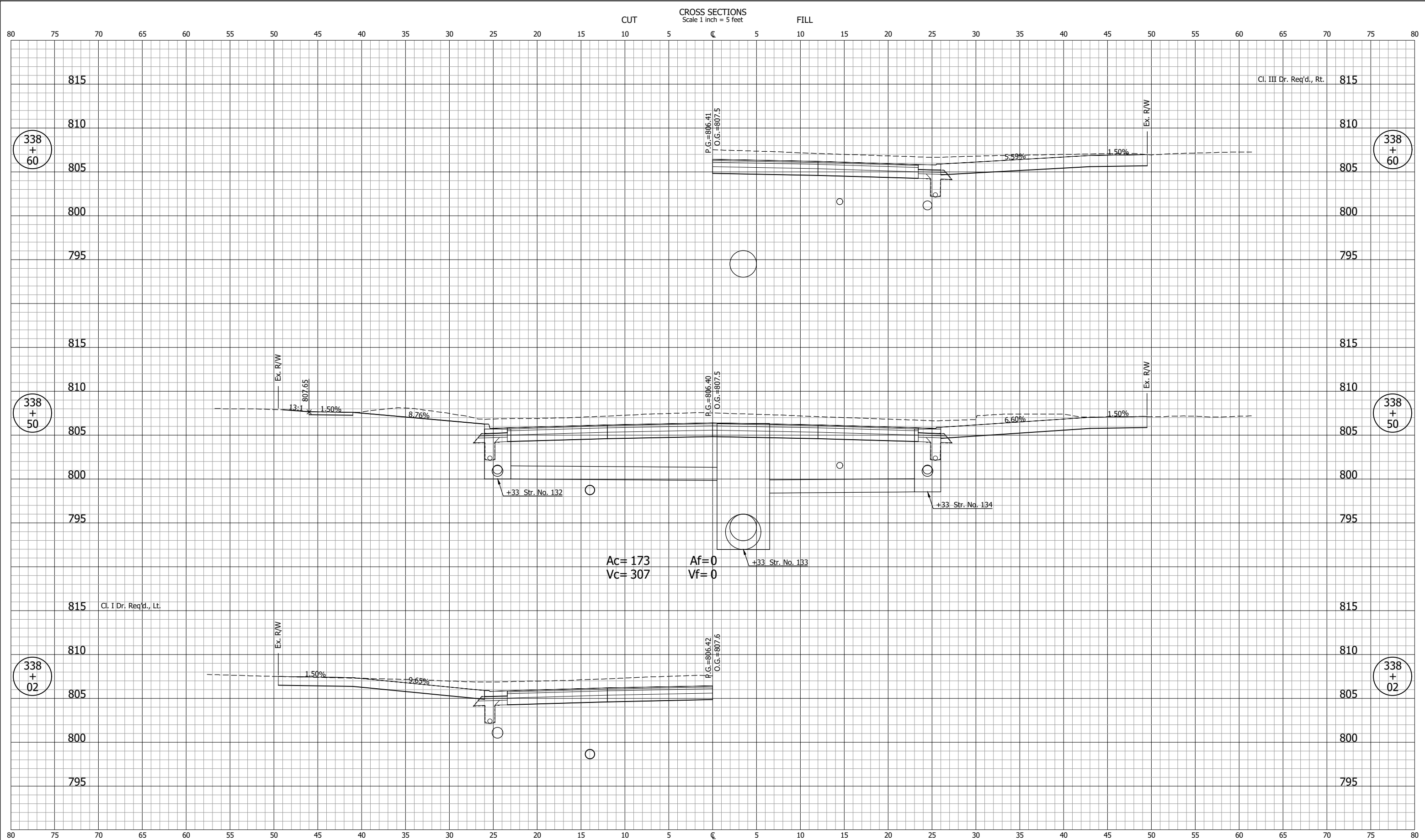

NOT FOR CONSTRUCTION		INDIANA DEPARTMENT OF TRANSPORTATION		SCALE 1" = 5'	BRIDGE FILE
		CROSS SECTIONS LINE "B"		DESIGNED: DGA	DRAWN: GDH
CHECKED: DGD	CHECKED: DGA			SURVEY BOOK	SHEETS 333 of 357
				CONTRACT R-43382	PROJECT 2001885

CROSS SECTIONS
Scale 1 inch = 5 feet

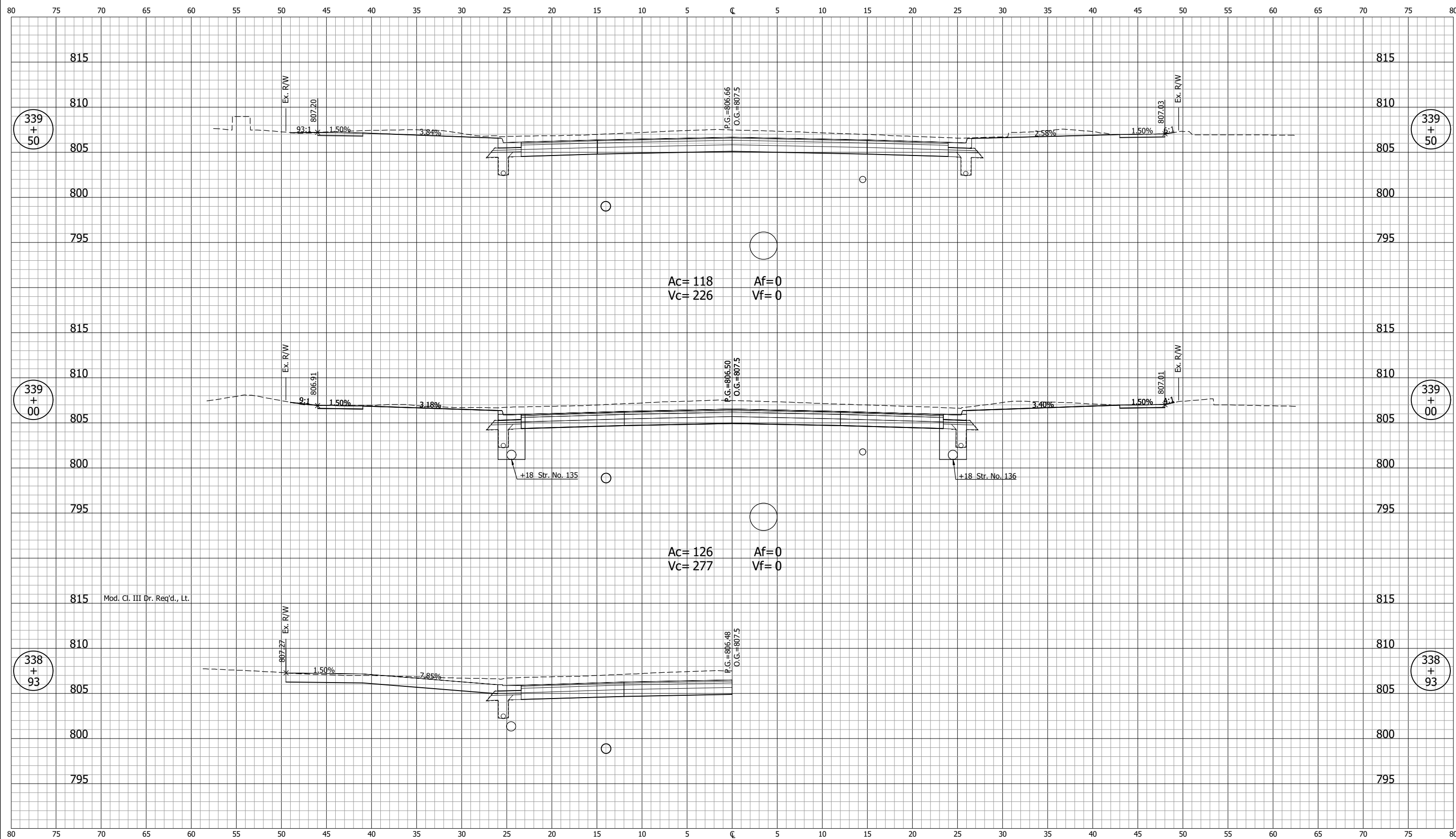

339
+
50

339
+
50

339
+
00

339
+
00

338
+
93

338
+
93

Ac= 118 Af= 0
Vc= 226 Vf= 0

Ac= 126 Af= 0
Vc= 277 Vf= 0

Ac= 126 Af= 0
Vc= 277 Vf= 0

NOT FOR CONSTRUCTION

DESIGNED: DGA DRAWN: GDH
CHECKED: DGD CHECKED: DGA

INDIANA
DEPARTMENT OF TRANSPORTATION

**CROSS SECTIONS
LINE "B"**

SCALE 1" = 5'	BRIDGE FILE
	DESIGNATION 2001885 & 2101797
SURVEY BOOK	SHEETS 334 of 357
CONTRACT R-43382	PROJECT 2001885

GDH - 2/9/2024 12:50 PM - U:\2021\202124 indot us35\Cad\C30\Design Files\212440D_C02.dwg (XS_58_B)

CROSS SECTIONS
Scale 1 inch = 5 feet

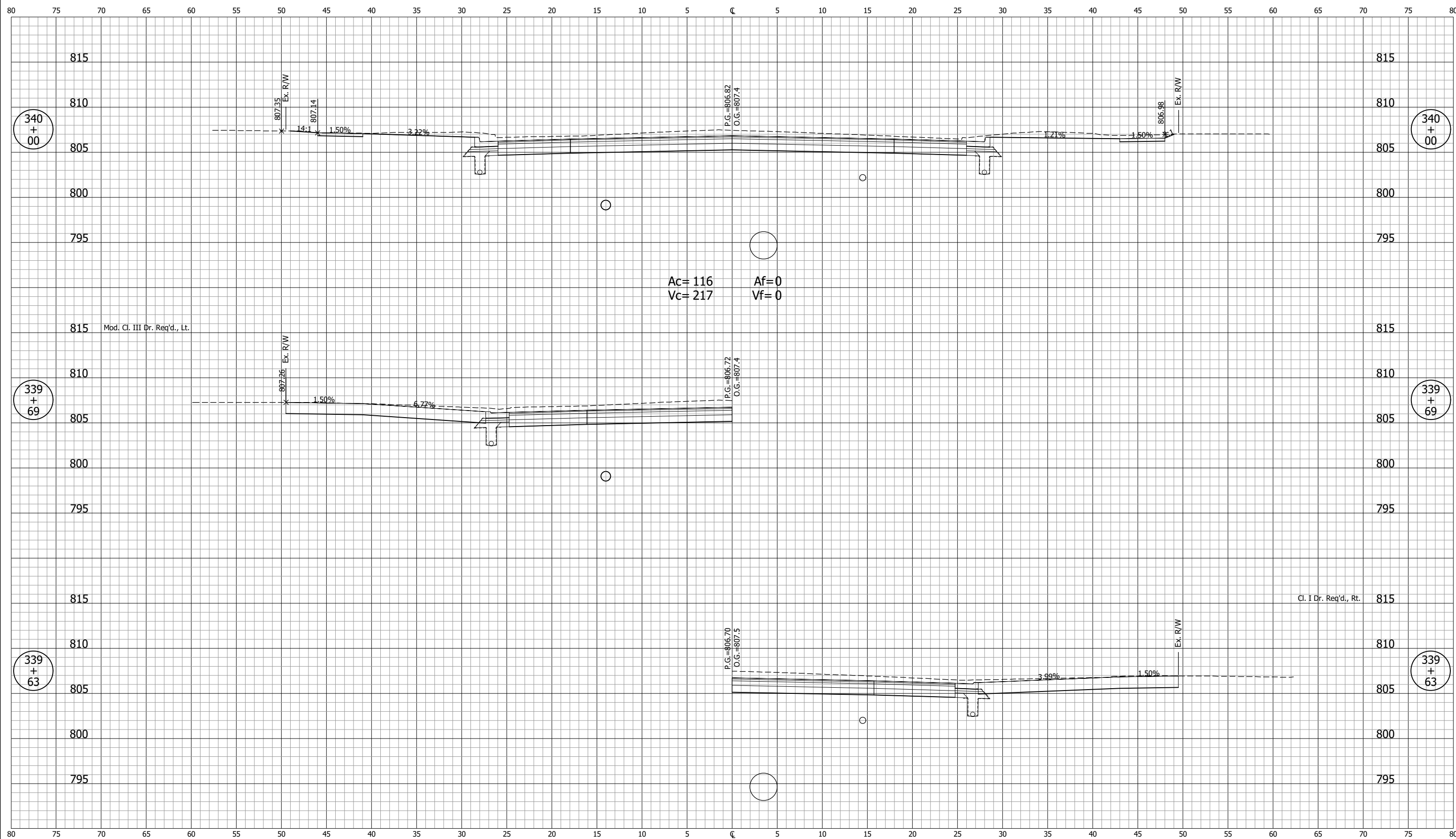

Ac= 116
Vc= 217
Af= 0
Vf= 0

Mod. Cl. III Dr. Req'd., Lt.

C. I Dr. Req'd., Rt.

NOT FOR CONSTRUCTION

DESIGNED: DGA DRAWN: GDH
CHECKED: DGD CHECKED: DGA

INDIANA
DEPARTMENT OF TRANSPORTATION

**CROSS SECTIONS
LINE "B"**

SCALE 1" = 5'	BRIDGE FILE
	DESIGNATION 2001885 & 2101797
SURVEY BOOK	SHEETS 335 of 357
CONTRACT R-43382	PROJECT 2001885

GDH - 2/9/2024 12:50 PM - U:\2021\202124 indot us35\Cad\C30\Design Files\212440D_C02.dwg (XS_60_B)

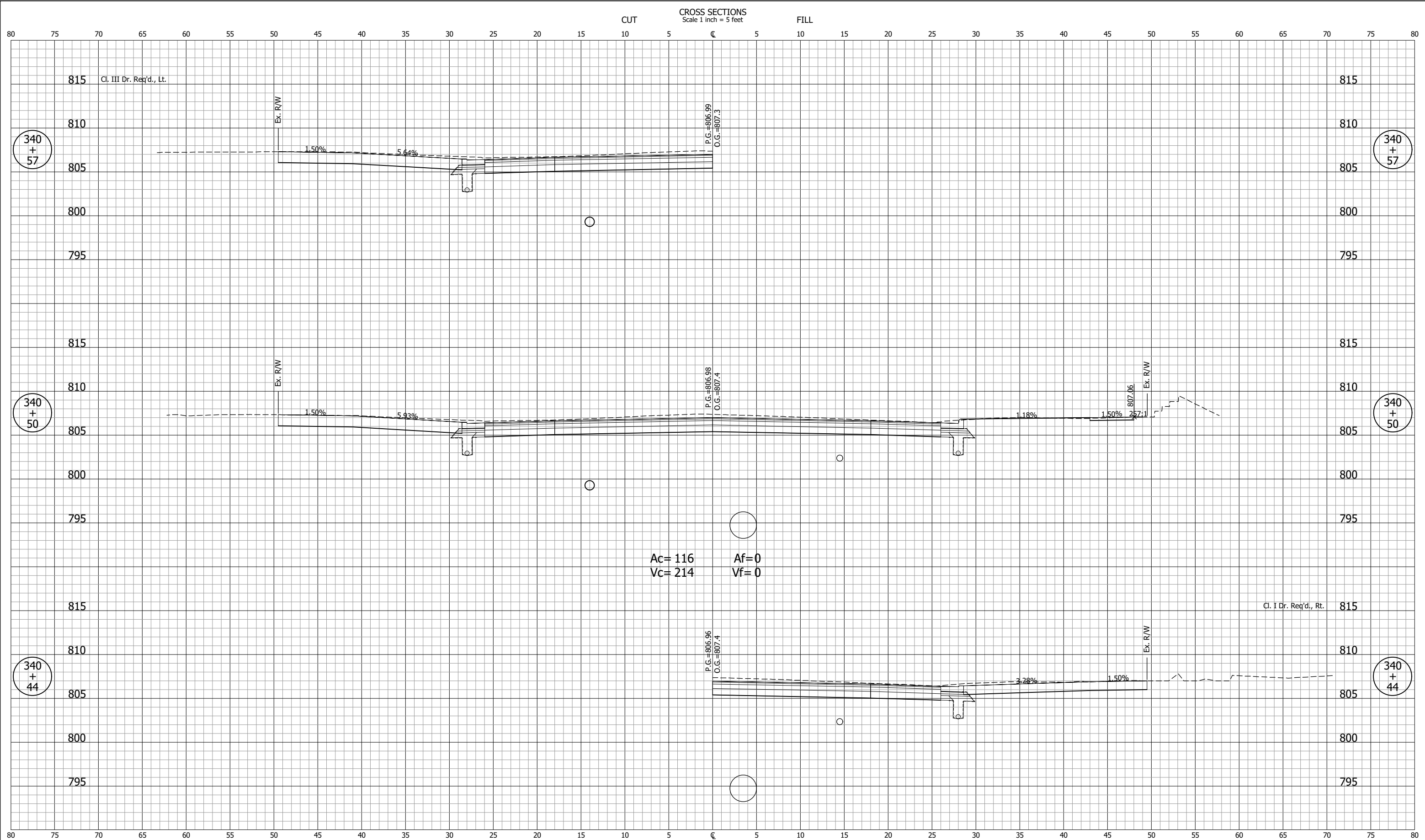

NOT FOR CONSTRUCTION		INDIANA DEPARTMENT OF TRANSPORTATION		SCALE 1" = 5'	BRIDGE FILE
DESIGNED: DGA		DRAWN: GDH		DESIGNATION 2001885 & 2101797	
CHECKED: DGD		CHECKED: DGA		SURVEY BOOK	SHEETS 336 of 357
		CROSS SECTIONS LINE "B"		CONTRACT R-43382	PROJECT 2001885

GDH - 2/9/2024 12:50 PM - U:\2021\202124.indot.us35\Cad\C30\Design Files\212440D_C02.dwg (XS_61_B)

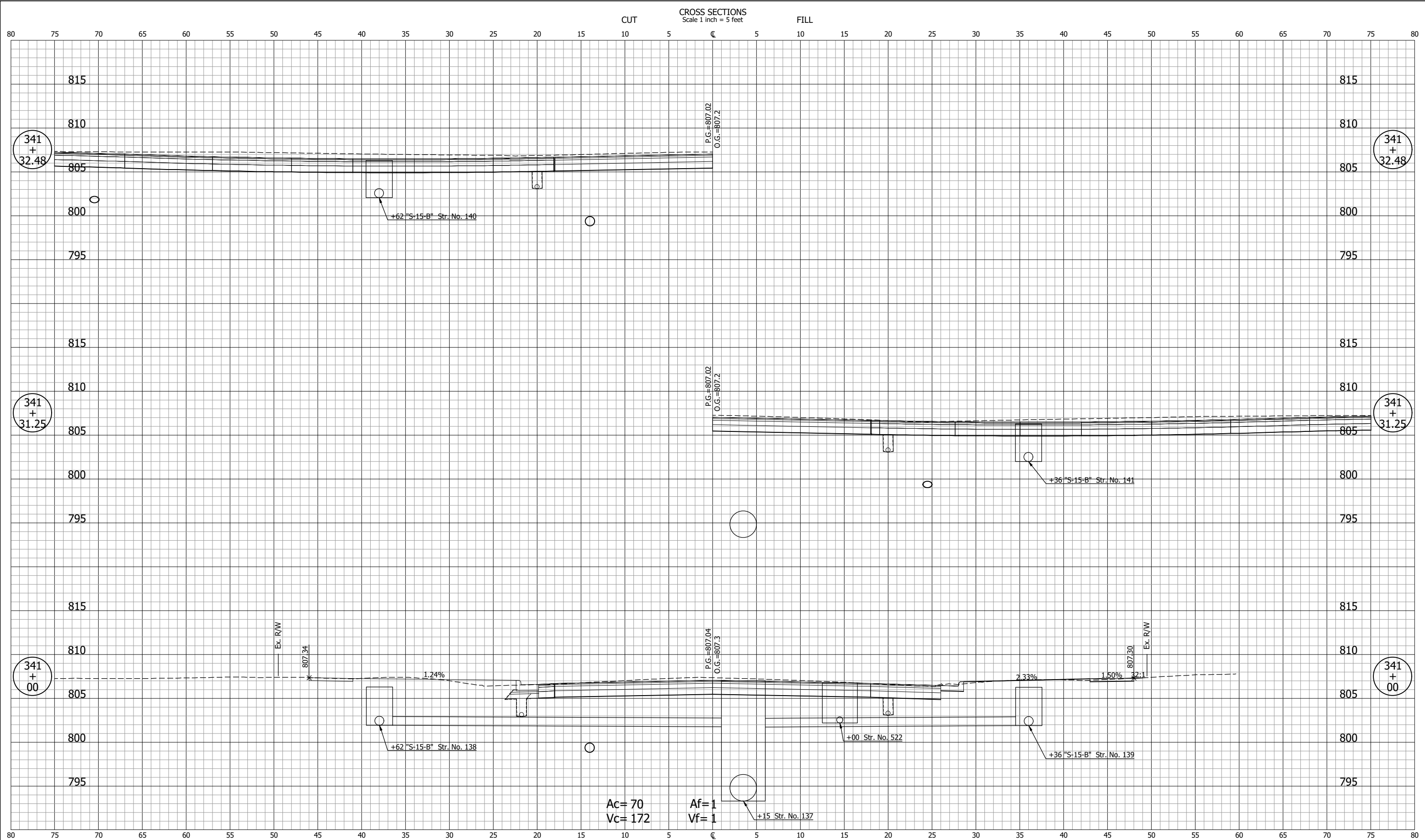

Ac= 70
Vc= 172
Af= 1
Vf= 1

NOT FOR CONSTRUCTION

DESIGNED: DGA	DRAWN: GDH
CHECKED: DGD	CHECKED: DGA

**INDIANA
DEPARTMENT OF TRANSPORTATION**

**CROSS SECTIONS
LINE "B"**

SCALE 1" = 5'	BRIDGE FILE
	DESIGNATION 2001885 & 2101797
SURVEY BOOK	SHEETS 337 of 357
CONTRACT R-43382	PROJECT 2001885

GDH - 2/9/2024 12:50 PM - U:\2021\202124.indot.us35\Cad\C30\Design Files\212440D_C02.dwg (XS_62_B)

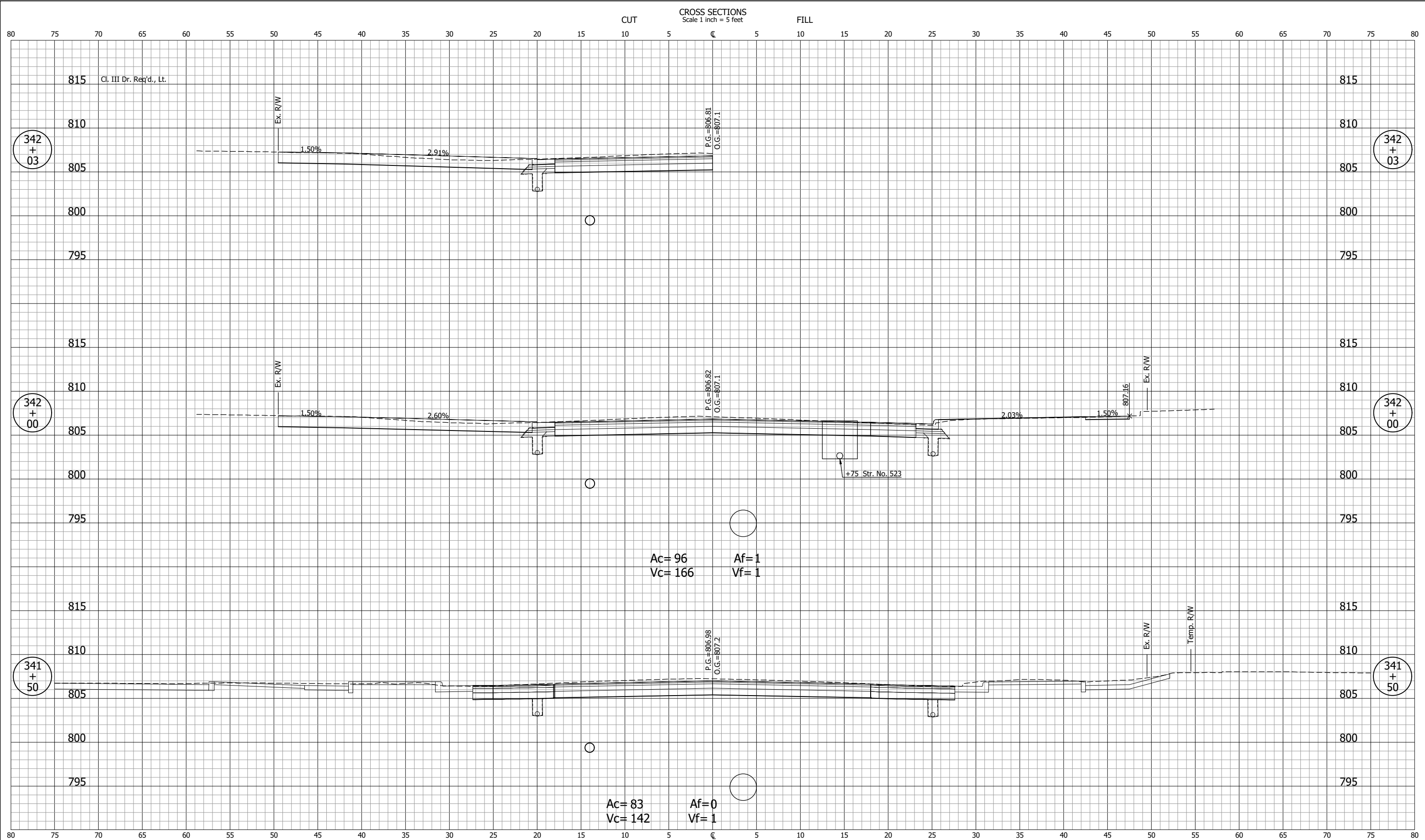

NOT FOR CONSTRUCTION		INDIANA DEPARTMENT OF TRANSPORTATION		SCALE 1" = 5'	BRIDGE FILE
DESIGNED: DGA		DRAWN: GDH		DESIGNATION 2001885 & 2101797	
CHECKED: DGD		CHECKED: DGA		SURVEY BOOK	SHEETS 338 of 357
		CROSS SECTIONS LINE "B"		CONTRACT R-43382	PROJECT 2001885

CROSS SECTIONS
Scale 1 inch = 5 feet

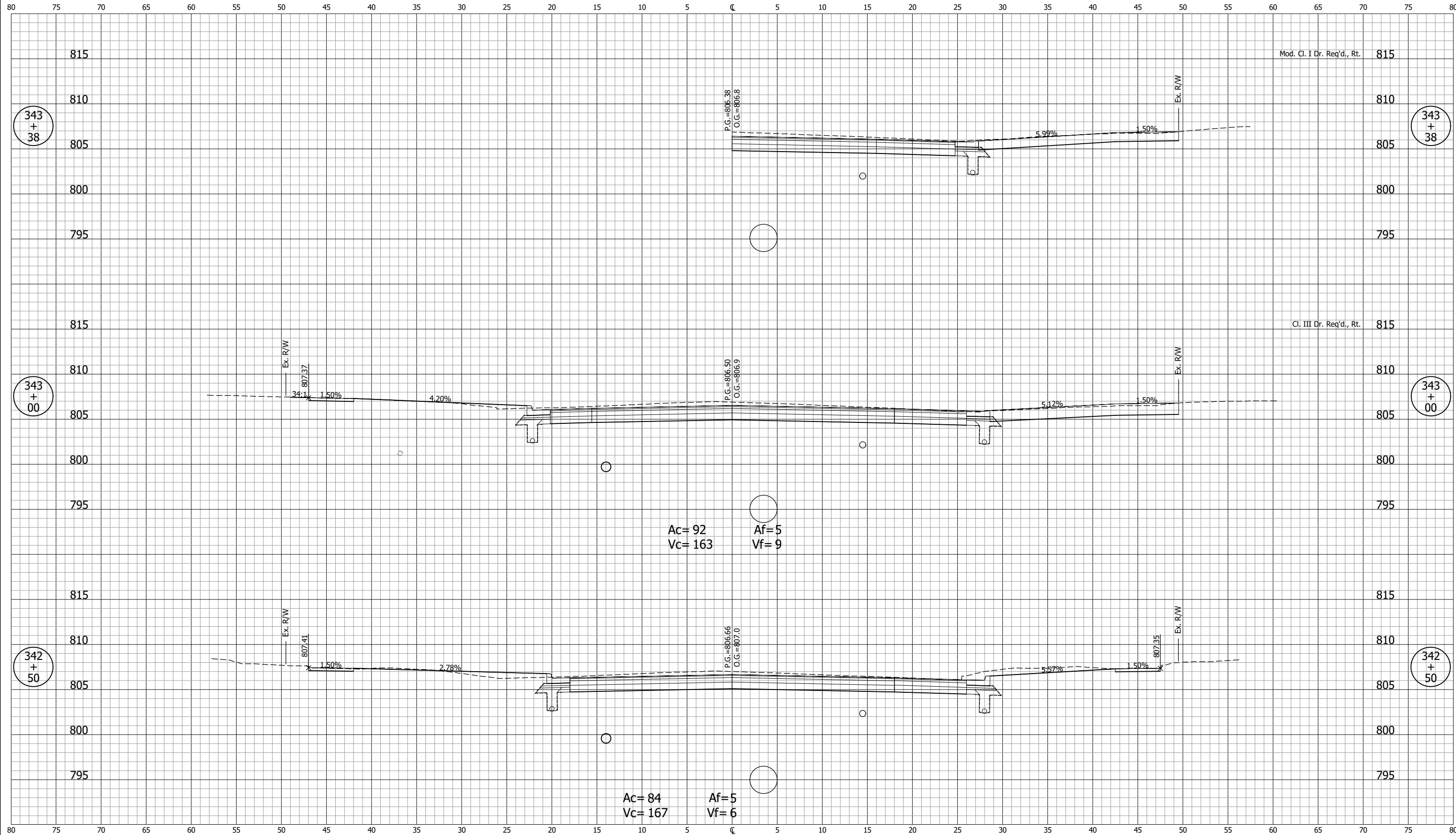

Ac=92
Vc=163
Af=5
Vf=9

Ac=84
Vc=167
Af=5
Vf=6

NOT FOR CONSTRUCTION

DESIGNED: DGA	DRAWN: GDH
CHECKED: DGD	CHECKED: DGA

**INDIANA
DEPARTMENT OF TRANSPORTATION**

**CROSS SECTIONS
LINE "B"**

SCALE 1" = 5'	BRIDGE FILE
	DESIGNATION 2001885 & 2101797
SURVEY BOOK	SHEETS 339 of 357
CONTRACT R-43382	PROJECT 2001885

GDH - 2/9/2024 12:50 PM - U:\2021\202124.indot us35\Cad\C30\Design Files\212440D_C02.dwg (XS_63)

CROSS SECTIONS
Scale 1 inch = 5 feet

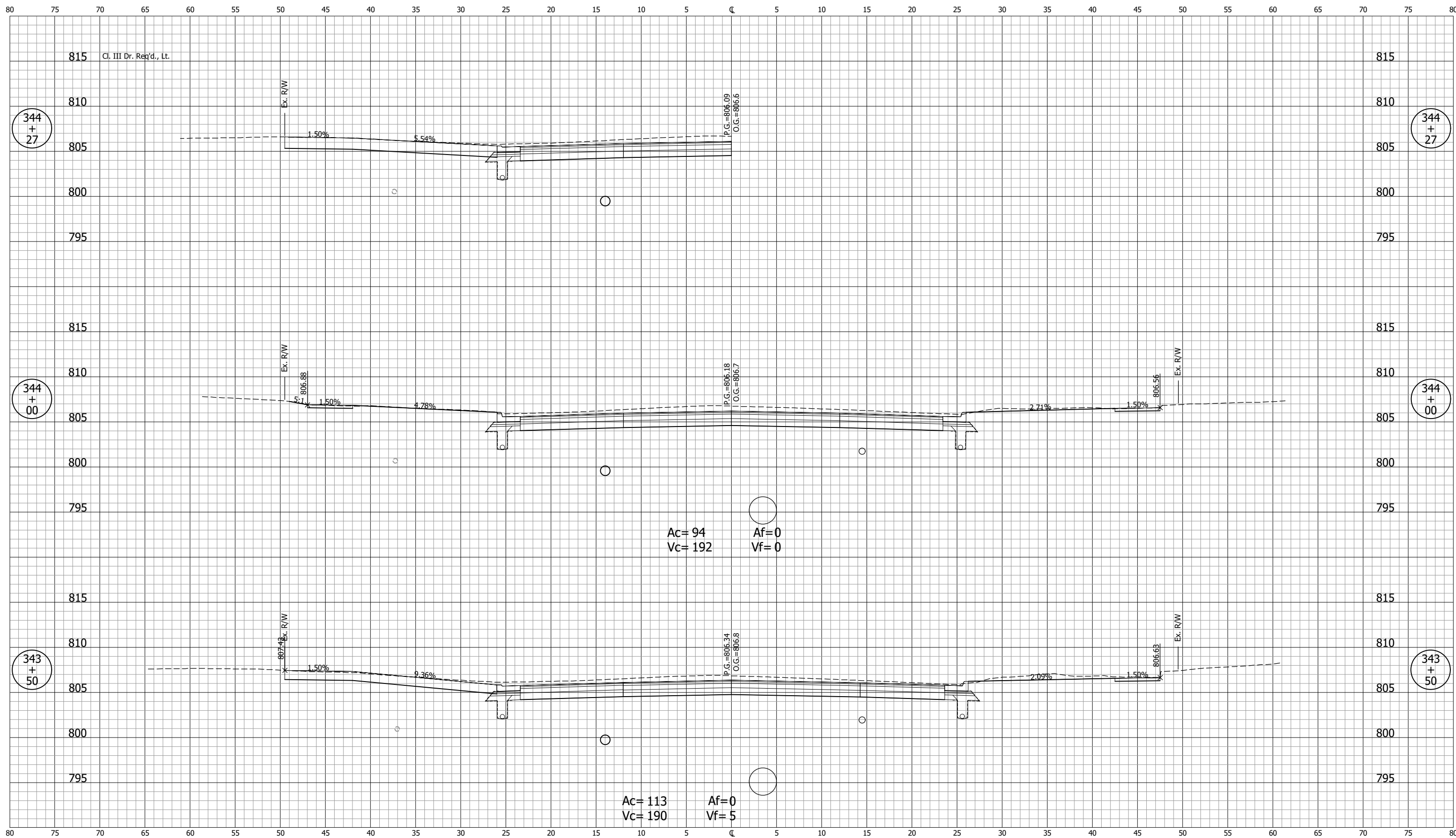

GDH - 2/9/2024 12:50 PM - U:\2021\202124 indot us35\Cad\C30\Design Files\212440D_C02.dwg (XS_64_B)

NOT FOR CONSTRUCTION		INDIANA DEPARTMENT OF TRANSPORTATION		SCALE 1" = 5'	BRIDGE FILE
		CROSS SECTIONS LINE "B"		DESIGNATION 2001885 & 2101797	
SURVEY BOOK	SHEETS 340 of 357				
CONTRACT R-43382	PROJECT 2001885				

GDH - 2/9/2024 12:51 PM - U:\2021\202124 indot us35\Cad\C30\Design Files\212440D_C02.dwg (XS_65_B)

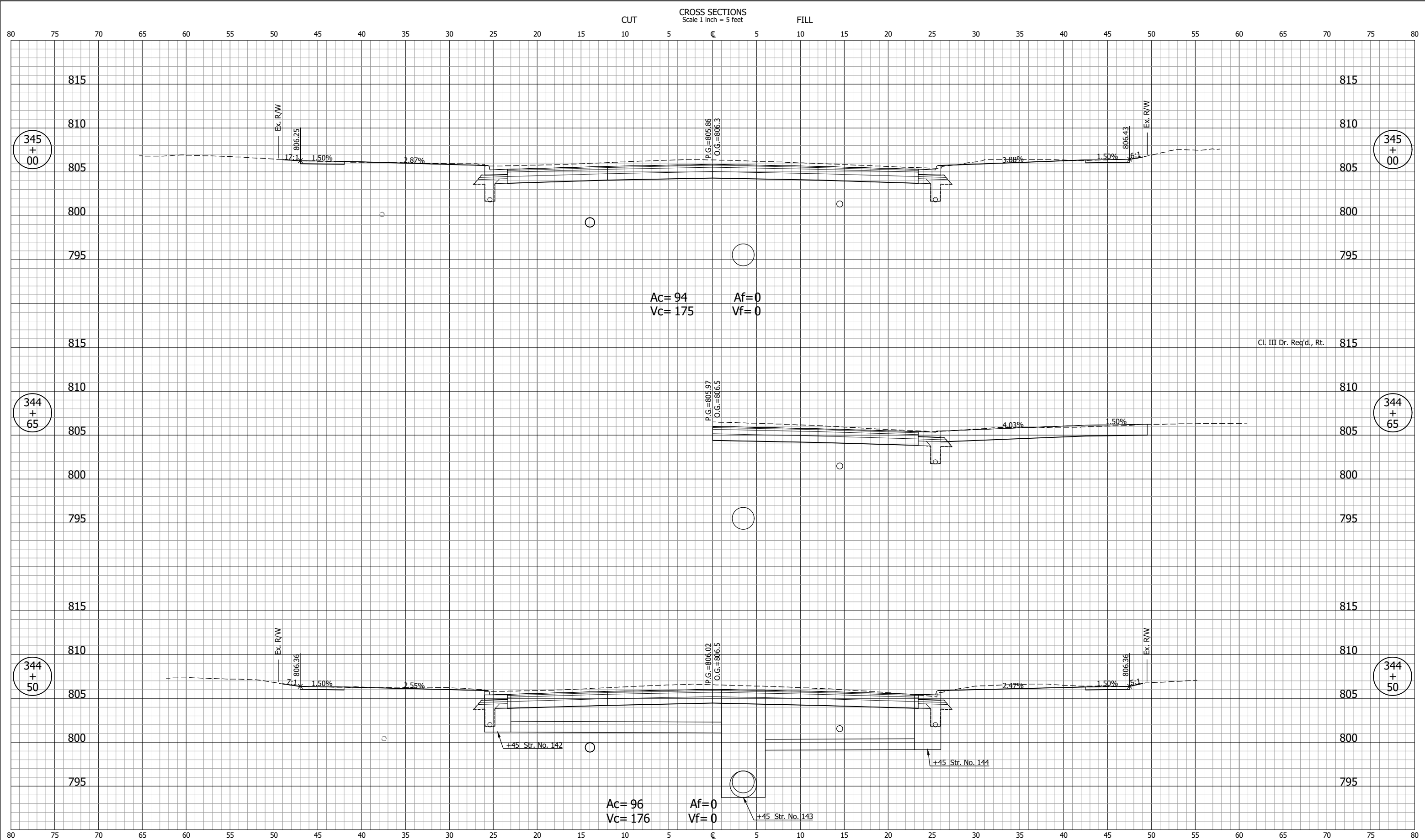

NOT FOR CONSTRUCTION

DESIGNED: DGA	DRAWN: GDH
CHECKED: DGD	CHECKED: DGA

INDIANA
DEPARTMENT OF TRANSPORTATION

CROSS SECTIONS
LINE "B"

SCALE 1" = 5'	BRIDGE FILE
SURVEY BOOK R-43382	DESIGNATION 2001885 & 2101797
CONTRACT R-43382	SHEETS 341 of 357 PROJECT 2001885

GDH - 2/9/2024 12:51 PM - U:\2021\202124 indot us35\Cad\C30\Design Files\212440D_C02.dwg (XS_67)

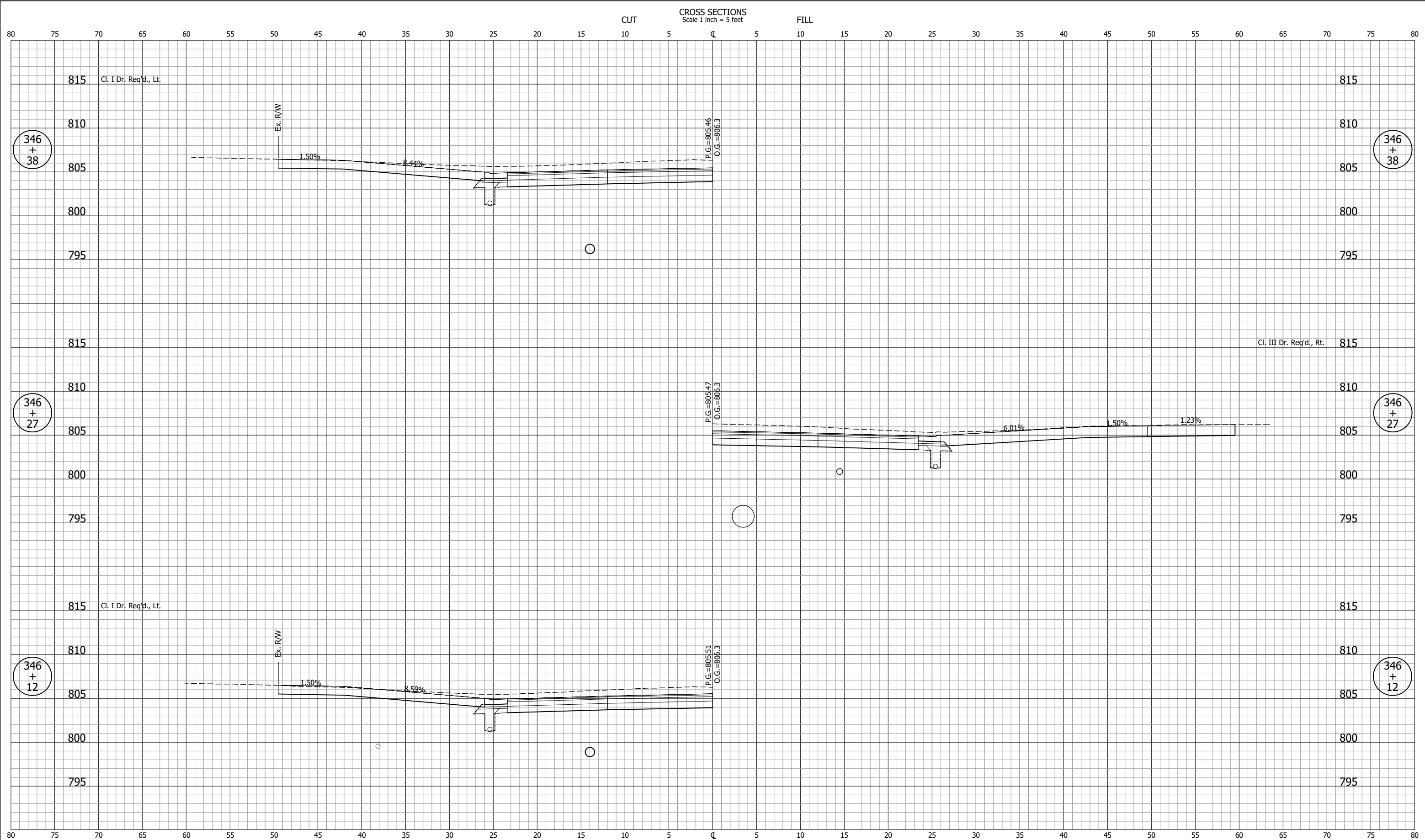

NOT FOR CONSTRUCTION		INDIANA DEPARTMENT OF TRANSPORTATION		SCALE 1" = 5'	BRIDGE FILE
		CROSS SECTIONS LINE "B"		DESIGNATION 2001885 & 2101797	
SURVEY BOOK	SHEETS 343 of 357				
CONTRACT R-43382	PROJECT 2001885				

CROSS SECTIONS
Scale 1 inch = 5 feet

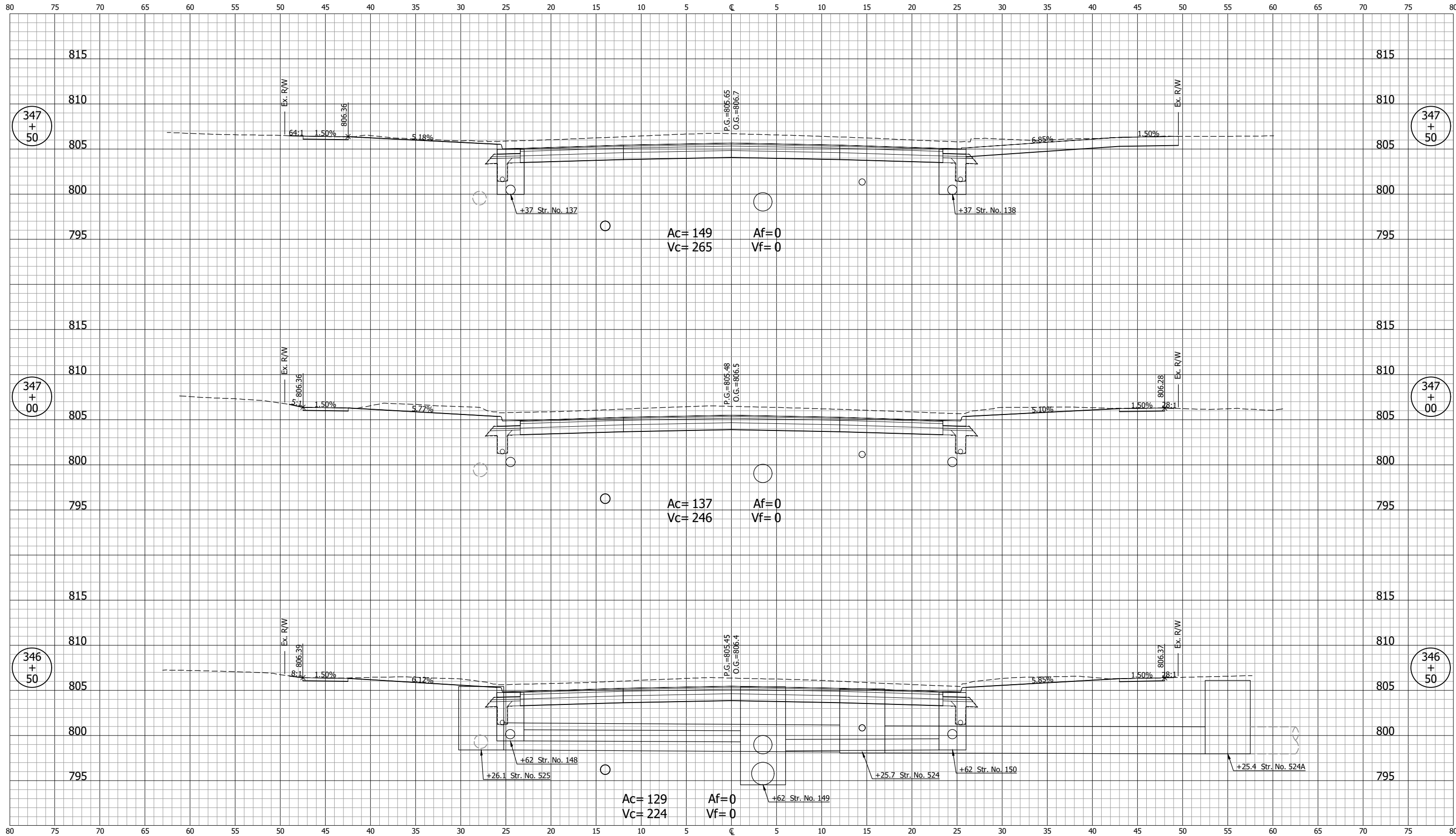

NOT FOR CONSTRUCTION

DESIGNED: DGA	DRAWN: GDH
CHECKED: DGD	CHECKED: DGA

INDIANA
DEPARTMENT OF TRANSPORTATION

**CROSS SECTIONS
LINE "B"**

SCALE 1" = 5'	BRIDGE FILE
	DESIGNATION 2001885 & 2101797
SURVEY BOOK	SHEETS 344 of 357
CONTRACT R-43382	PROJECT 2001885

GDH - 2/9/2024 12:51 PM - U:\2021\202124 indot us35\Cad\C30\Design Files\212440D_C02.dwg (XS_69_B)

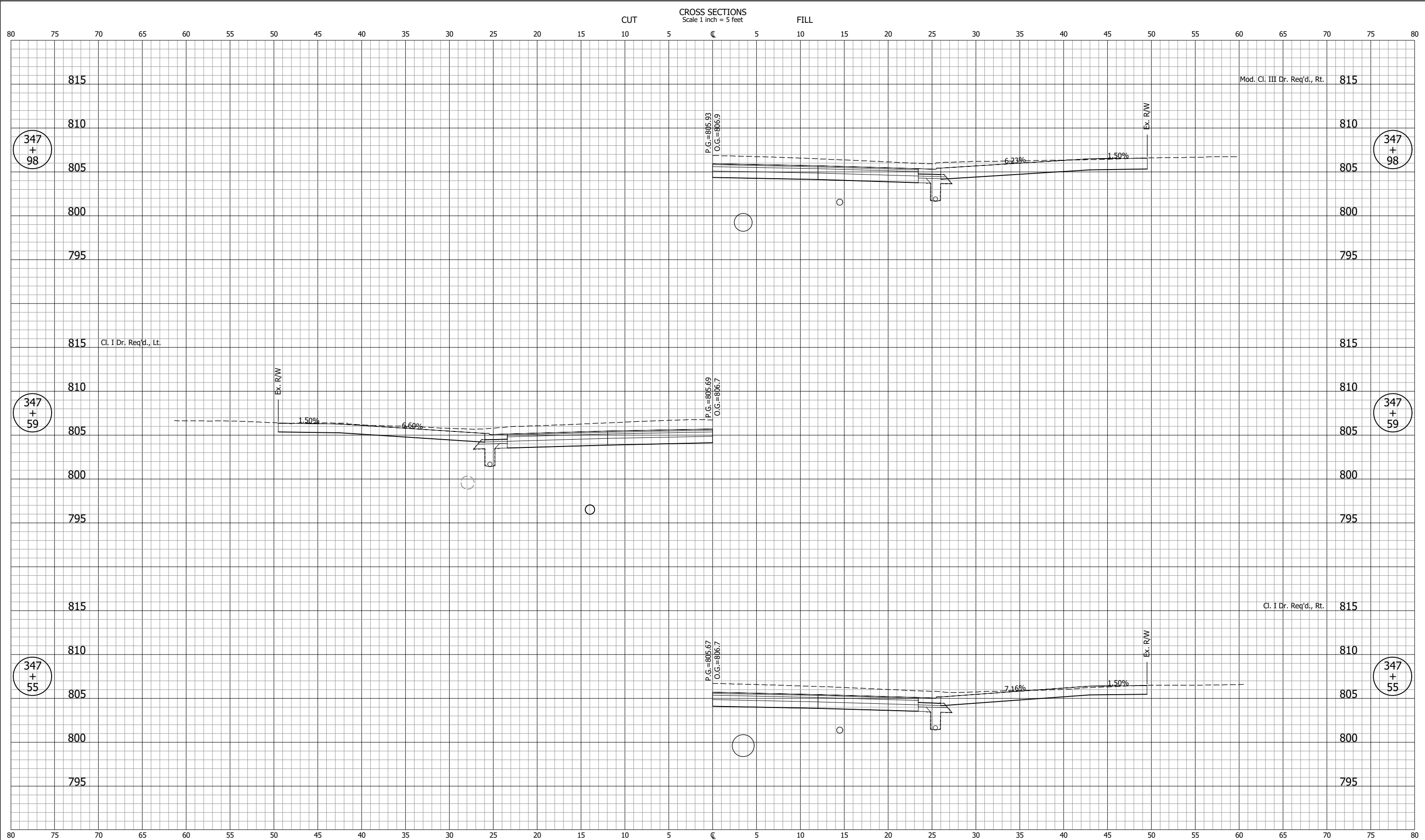

NOT FOR CONSTRUCTION		INDIANA DEPARTMENT OF TRANSPORTATION		SCALE 1" = 5'	BRIDGE FILE
		CROSS SECTIONS LINE "B"		DESIGNATION 2001885 & 2101797	
SURVEY BOOK	SHEETS				
CONTRACT R-43382	345			of	357
DESIGNED: DGA	DRAWN: GDH			PROJECT 2001885	
CHECKED: DGD	CHECKED: DGA				

GDH - 2/9/2024 12:51 PM - U:\2021\202124 indot us35\Cad\C30\Design Files\212440D_C02.dwg (XS_70_B)

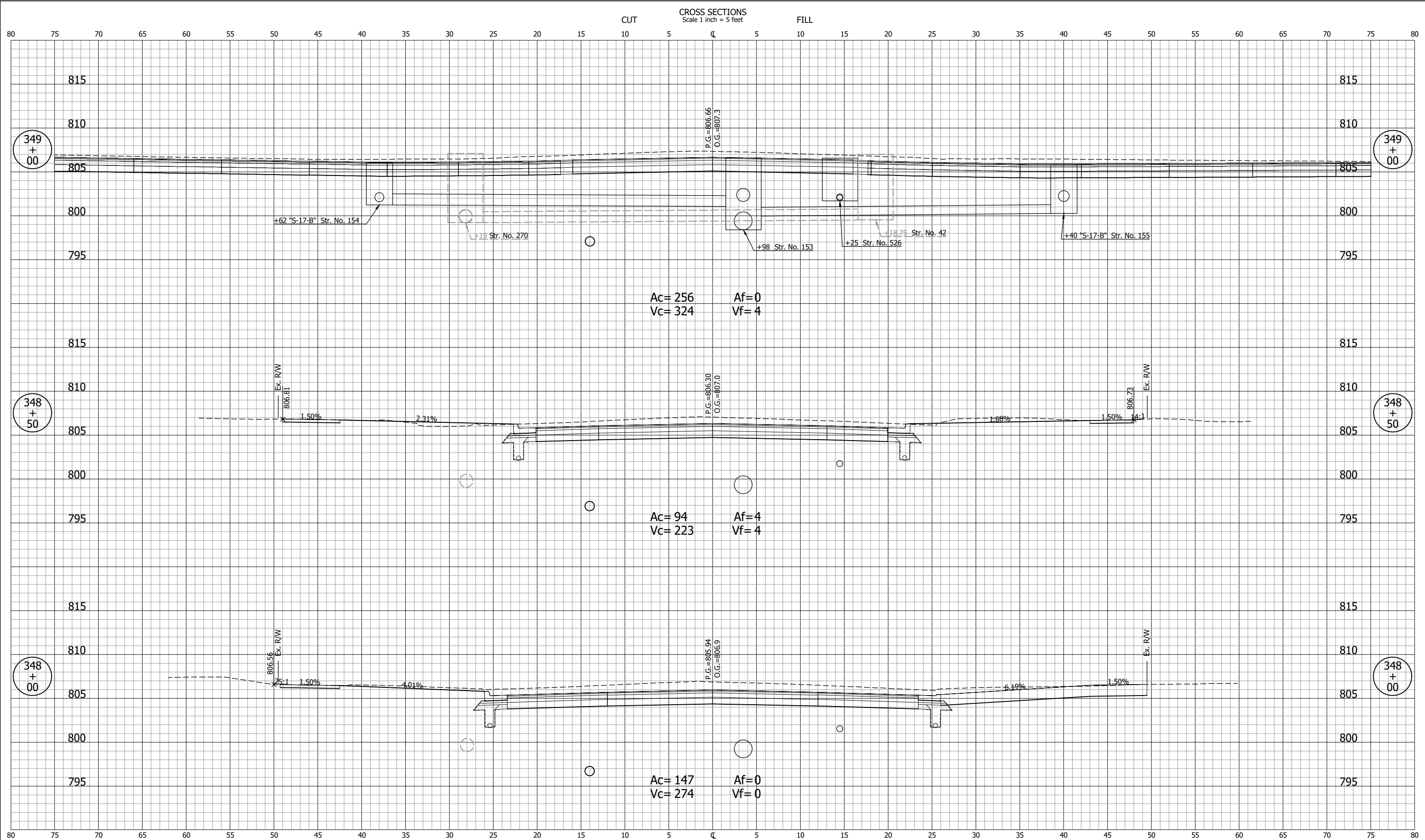

NOT FOR CONSTRUCTION		INDIANA DEPARTMENT OF TRANSPORTATION		SCALE 1" = 5'	BRIDGE FILE
DESIGNED: DGA		DRAWN: GDH		DESIGNATION 2001885 & 2101797	
CHECKED: DGD		CHECKED: DGA		SURVEY BOOK	SHEETS 346 of 357
		CROSS SECTIONS LINE "B"		CONTRACT R-43382	PROJECT 2001885

CROSS SECTIONS
Scale 1 inch = 5 feet

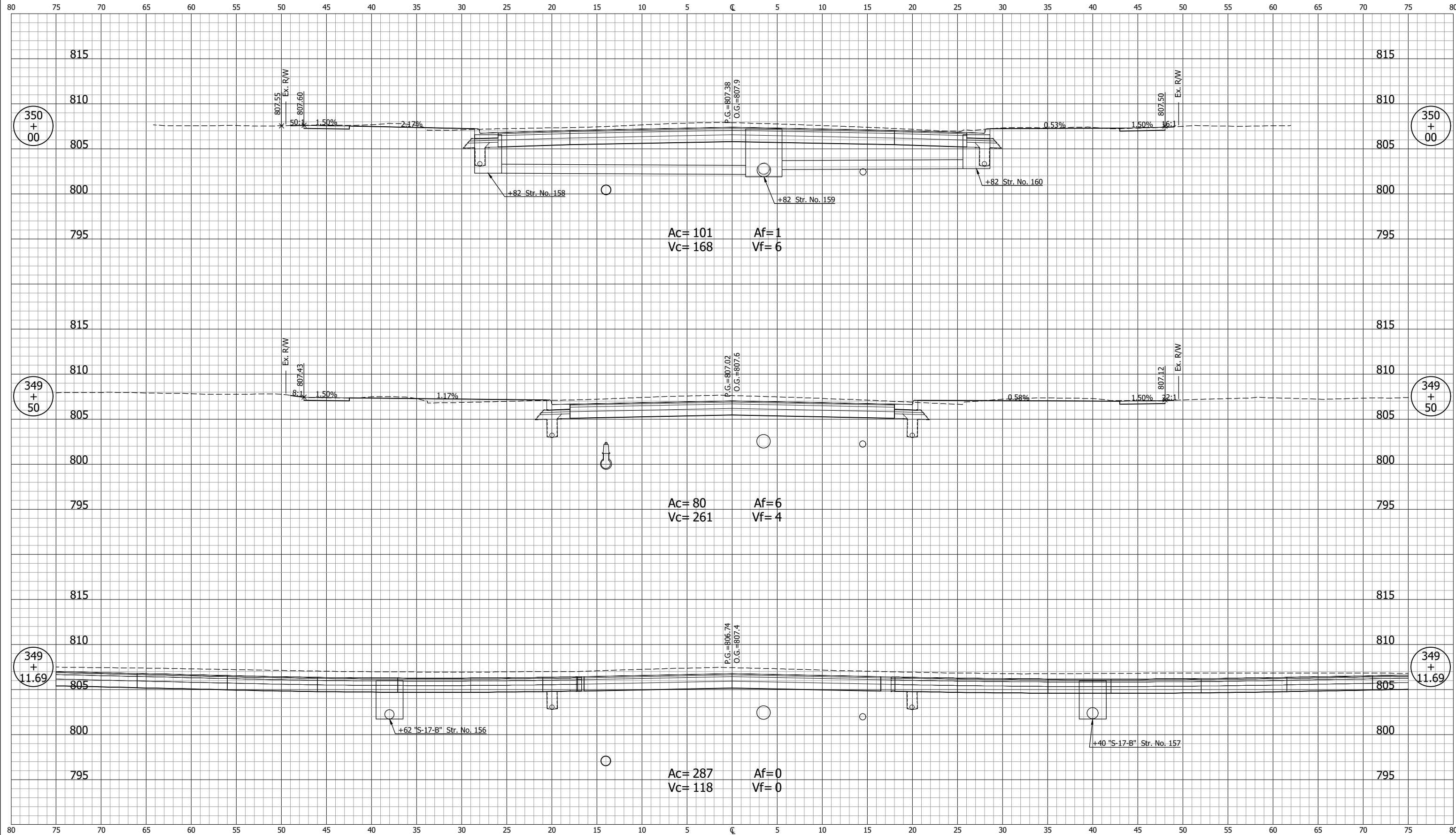

NOT FOR CONSTRUCTION		INDIANA DEPARTMENT OF TRANSPORTATION		SCALE 1" = 5'	BRIDGE FILE
		CROSS SECTIONS LINE "B"		DESIGNATION 2001885 & 2101797	
SURVEY BOOK	SHEETS 347 of 357				
CONTRACT R-43382	PROJECT 2001885				

GDH - 2/9/2024 12:51 PM - U:\2021\2021124 indot us35\Cad\C30\Design Files\212440D_C02.dwg (XS_71_B)

GDH - 2/9/2024 12:51 PM - U:\2021\202124 indot us35\Cad\C30\Design Files\212440D_C02.dwg (XS_72_B)

CROSS SECTIONS
Scale 1 inch = 5 feet

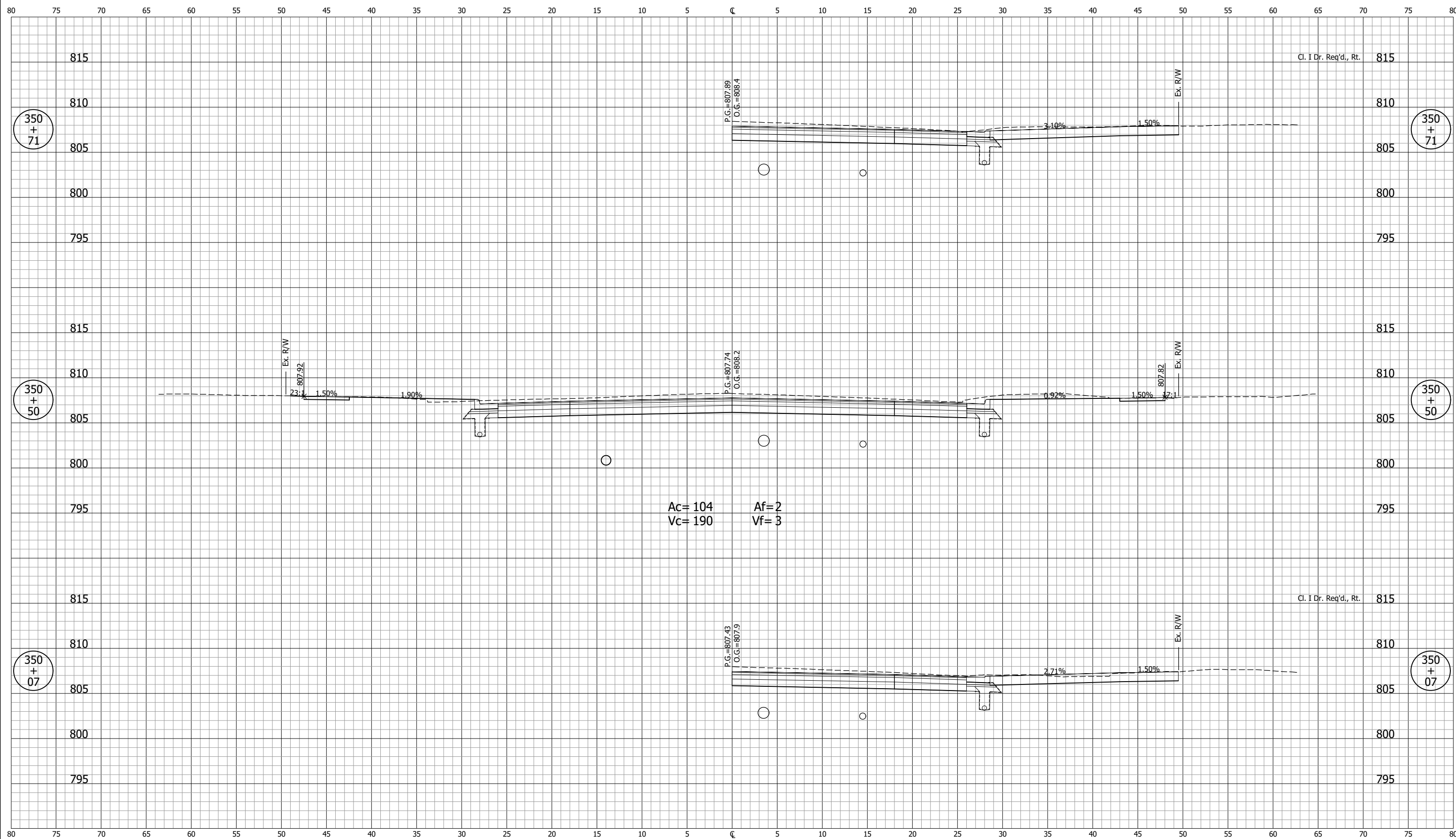

NOT FOR CONSTRUCTION		INDIANA DEPARTMENT OF TRANSPORTATION		SCALE 1" = 5'	BRIDGE FILE
DESIGNED: DGA		DRAWN: GDH		DESIGNATION 2001885 & 2101797	
CHECKED: DGD		CHECKED: DGA		SURVEY BOOK	SHEETS 348 of 357
		CROSS SECTIONS LINE "B"		CONTRACT R-43382	PROJECT 2001885

CROSS SECTIONS
Scale 1 inch = 5 feet

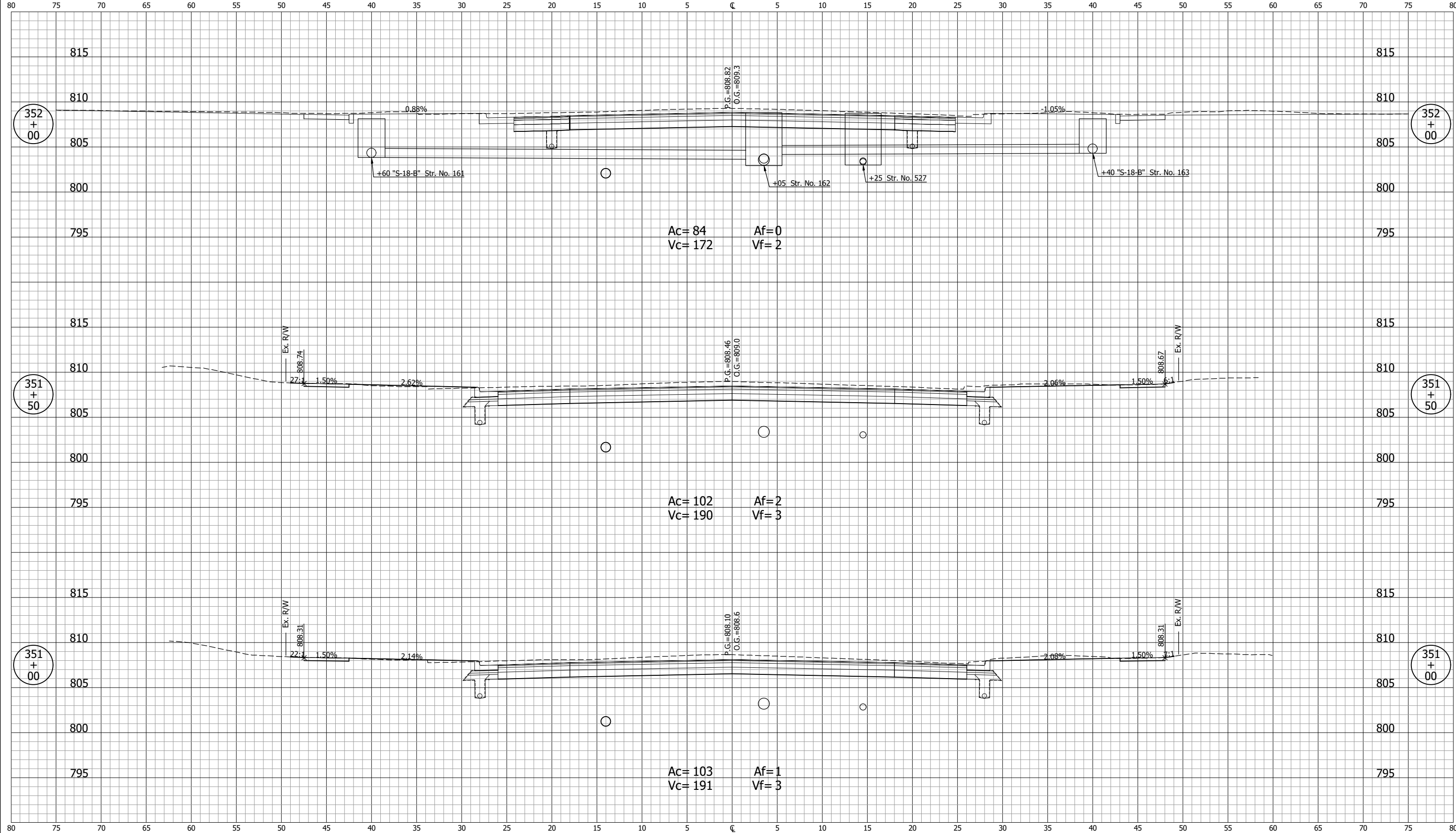

Ac= 84 Af= 0
Vc= 172 Vf= 2

Ac= 102 Af= 2
Vc= 190 Vf= 3

Ac= 103 Af= 1
Vc= 191 Vf= 3

NOT FOR CONSTRUCTION		INDIANA DEPARTMENT OF TRANSPORTATION		SCALE 1" = 5'	BRIDGE FILE
DESIGNED: DGA	DRAWN: GDH	CROSS SECTIONS LINE "B"		DESIGNATION 2001885 & 2101797	
CHECKED: DGD	CHECKED: DGA			SURVEY BOOK	SHEETS 349 of 357
				CONTRACT R-43382	PROJECT 2001885

GDH - 2/9/2024 12:51 PM - U:\2021\202124 indot us35\Cad\C30\Design Files\212440D_C02.dwg (XS_73_B)

GDH - 2/9/2024 12:51 PM - U:\2021\202124\indot_us35\Cad\C30\Design Files\212440D_C02.dwg (XS_74_B)

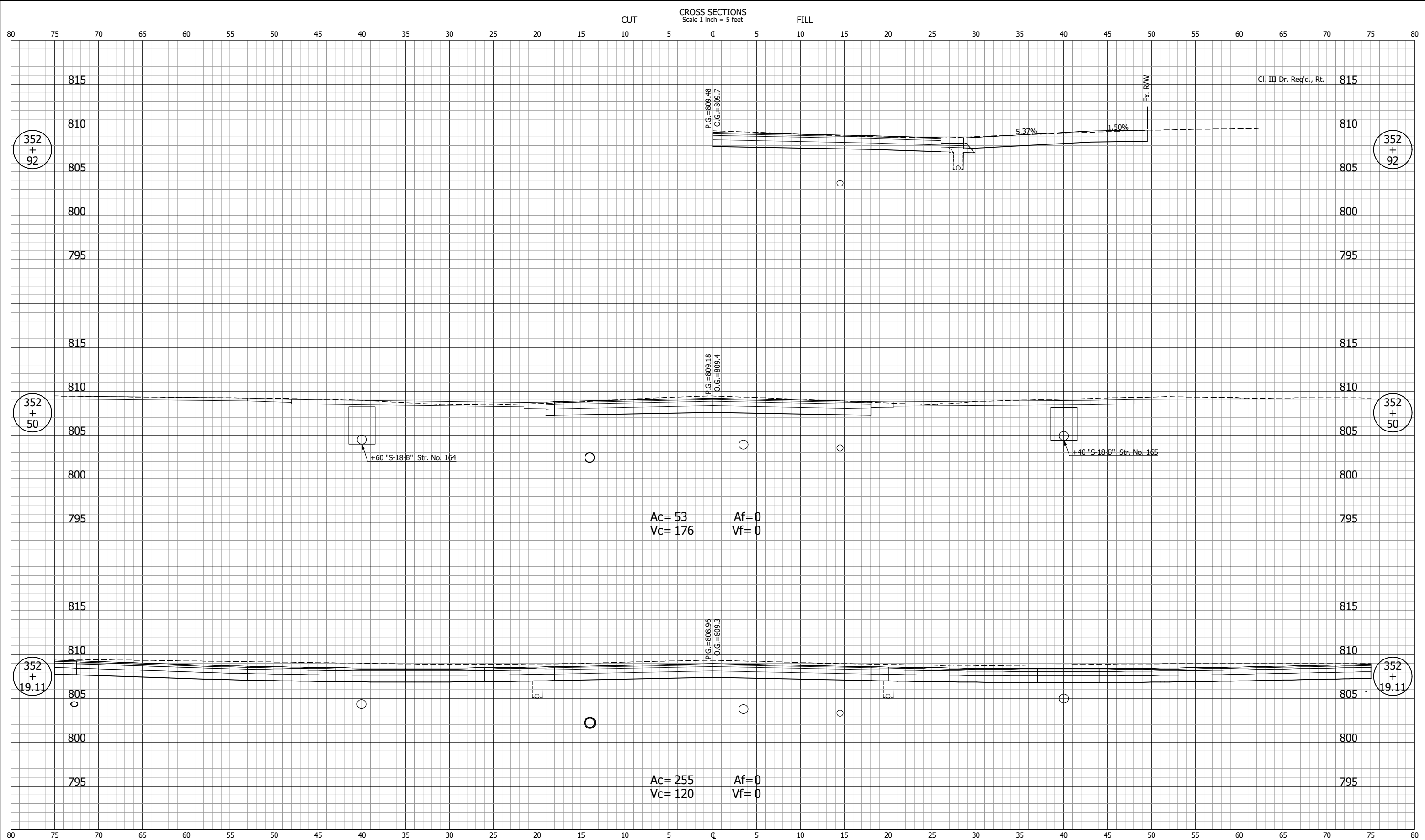

NOT FOR CONSTRUCTION		INDIANA DEPARTMENT OF TRANSPORTATION		SCALE 1" = 5'	BRIDGE FILE
		CROSS SECTIONS LINE "B"		DESIGNATION 2001885 & 2101797	
DESIGNED: DGA	DRAWN: GDH			SURVEY BOOK	SHEETS
CHECKED: DGD	CHECKED: DGA			CONTRACT R-43382	350 of 357 PROJECT 2001885

CROSS SECTIONS
Scale 1 inch = 5 feet

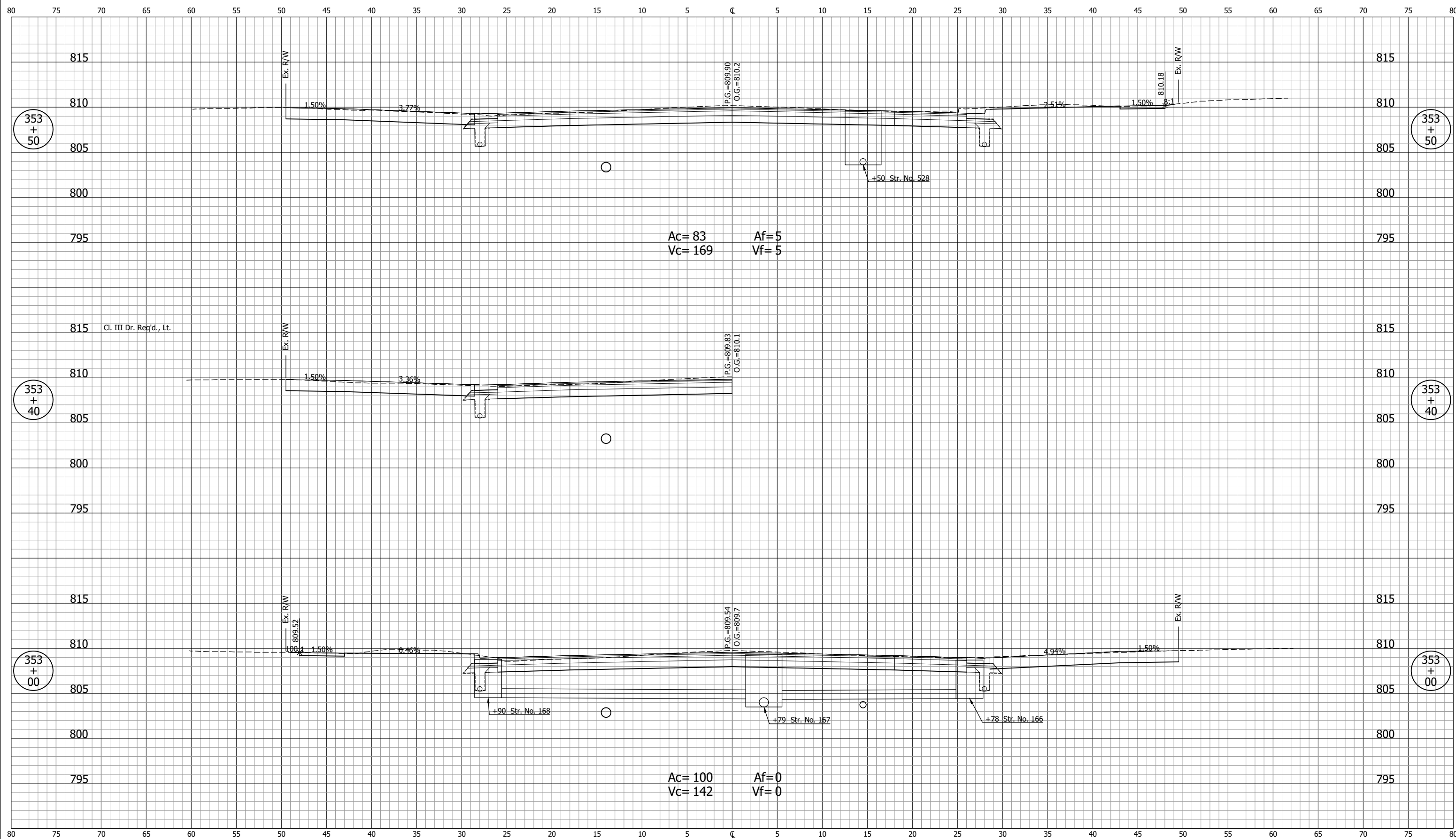

Ac= 83
Vc= 169
Af= 5
Vf= 5

C. III Dr. Req'd., Lt.

Ac= 100
Vc= 142
Af= 0
Vf= 0

NOT FOR CONSTRUCTION		INDIANA DEPARTMENT OF TRANSPORTATION		SCALE 1" = 5'	BRIDGE FILE
		CROSS SECTIONS LINE "B"		DESIGNATION 2001885 & 2101797	
DESIGNED: DGA	DRAWN: GDH			SURVEY BOOK	SHEETS 351 of 357
CHECKED: DGD	CHECKED: DGA			CONTRACT R-43382	PROJECT 2001885

GDH - 2/9/2024 12:51 PM - U:\2021\202124 indot us35\Cad\C30\Design Files\212440D_C02.dwg (XS_75_B)

GDH - 2/9/2024 12:51 PM - U:\2021\202124.indot.us35\Cad\C30\Design Files\212440D_C02.dwg (XS_76_B)

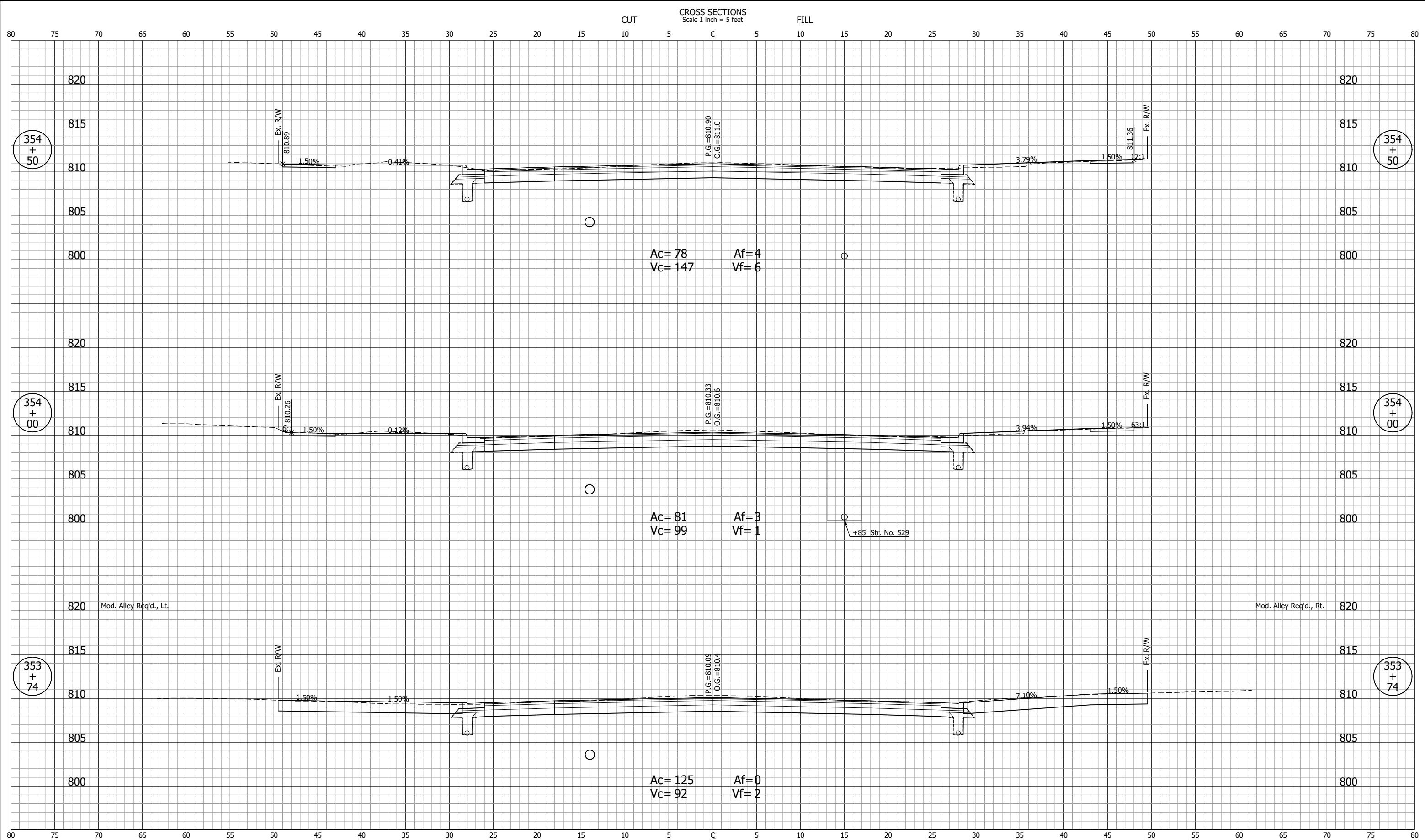

NOT FOR CONSTRUCTION		INDIANA DEPARTMENT OF TRANSPORTATION		SCALE 1" = 5'	BRIDGE FILE
DESIGNED: DGA		DRAWN: GDH		DESIGNATION 2001885 & 2101797	
CHECKED: DGD		CHECKED: DGA		SURVEY BOOK	SHEETS 352 of 357
		CROSS SECTIONS LINE "B"		CONTRACT R-43382	PROJECT 2001885

GDH - 2/9/2024 12:52 PM - U:\2021\202124.indot.us35\Cad\C30\Design Files\212440D_C02.dwg (XS_77_B)

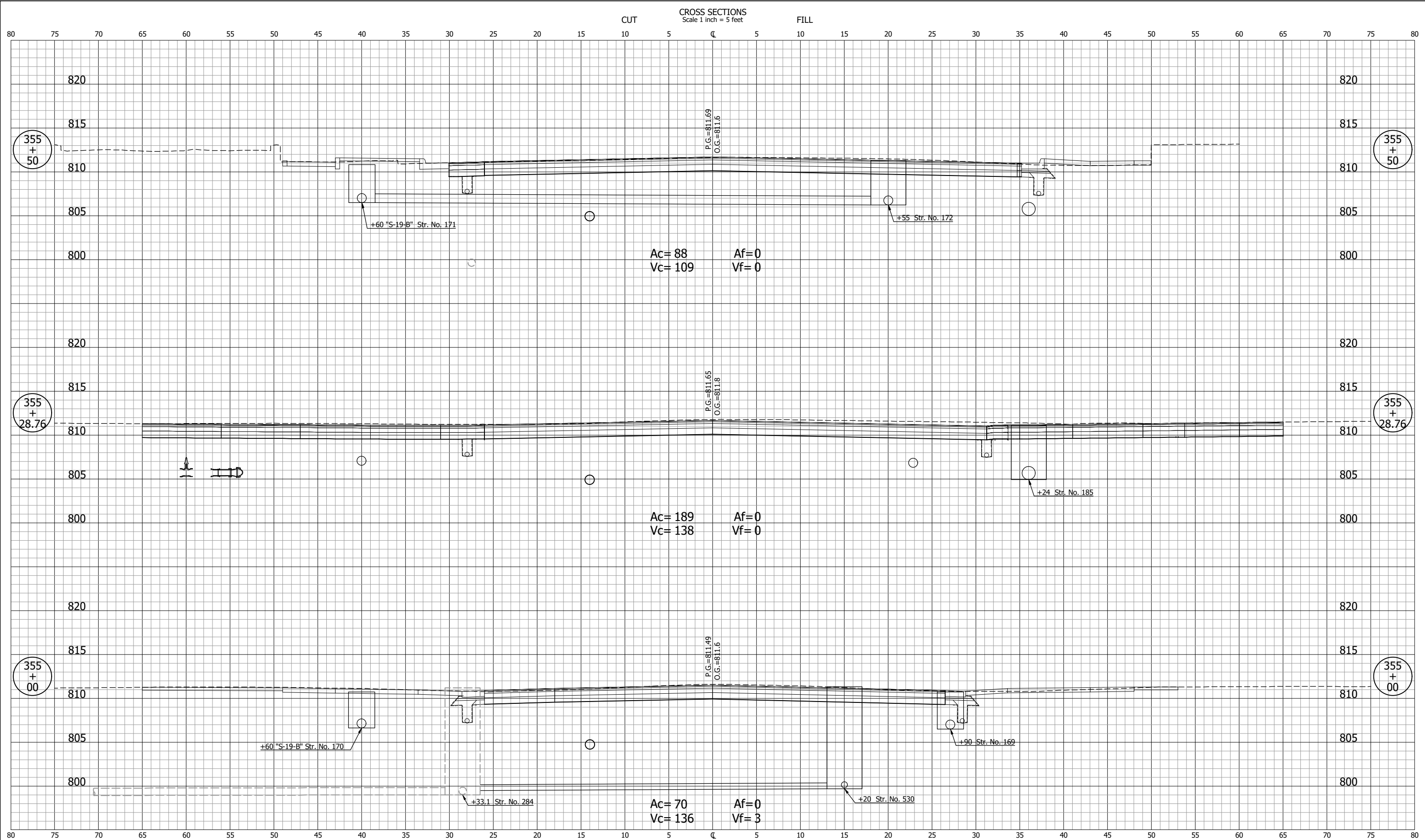

NOT FOR CONSTRUCTION		INDIANA DEPARTMENT OF TRANSPORTATION		SCALE 1" = 5'	BRIDGE FILE
		CROSS SECTIONS LINE "B"		DESIGNATION 2001885 & 2101797	
DESIGNED: DGA	DRAWN: GDH			SURVEY BOOK	SHEETS
CHECKED: DGD	CHECKED: DGA			CONTRACT R-43382	353 of 357 PROJECT 2001885

CROSS SECTIONS
Scale 1 inch = 5 feet

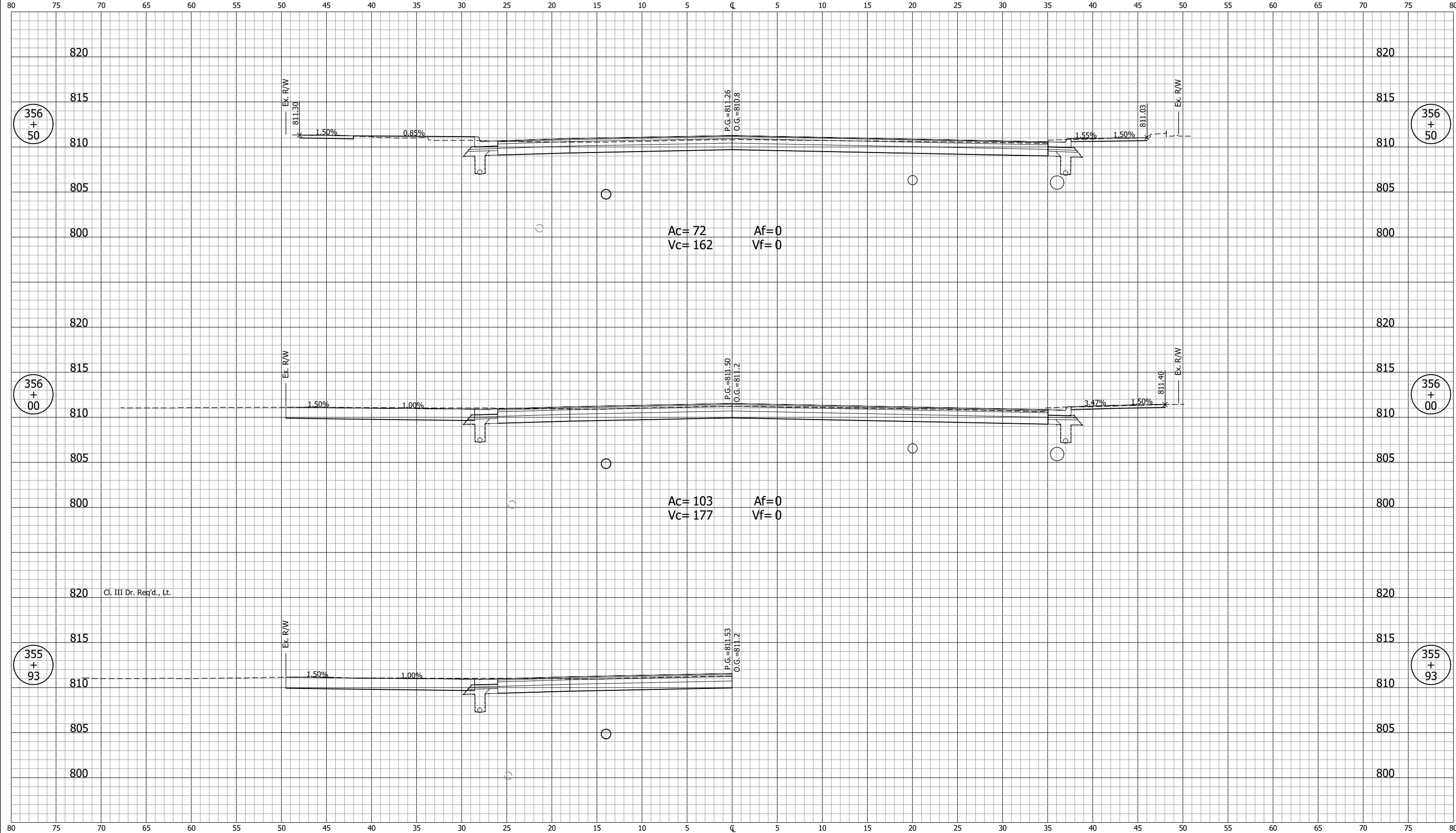

Cl. III Dr. Req'd., Lt.

GDH - 2/9/2024 12:52 PM - U:\2021\202124 indot us35\Cad\C30\Design Files\212440D_C02.dwg (XS_78_B)

NOT FOR CONSTRUCTION		INDIANA DEPARTMENT OF TRANSPORTATION		SCALE 1" = 5'	BRIDGE FILE
DESIGNED: DGA		DRAWN: GDH		DESIGNATION 2001885 & 2101797	
CHECKED: DGD		CHECKED: DGA		SURVEY BOOK	SHEETS 354 of 357
		CROSS SECTIONS LINE "B"		CONTRACT R-43382	PROJECT 2001885

CROSS SECTIONS
Scale 1 inch = 5 feet

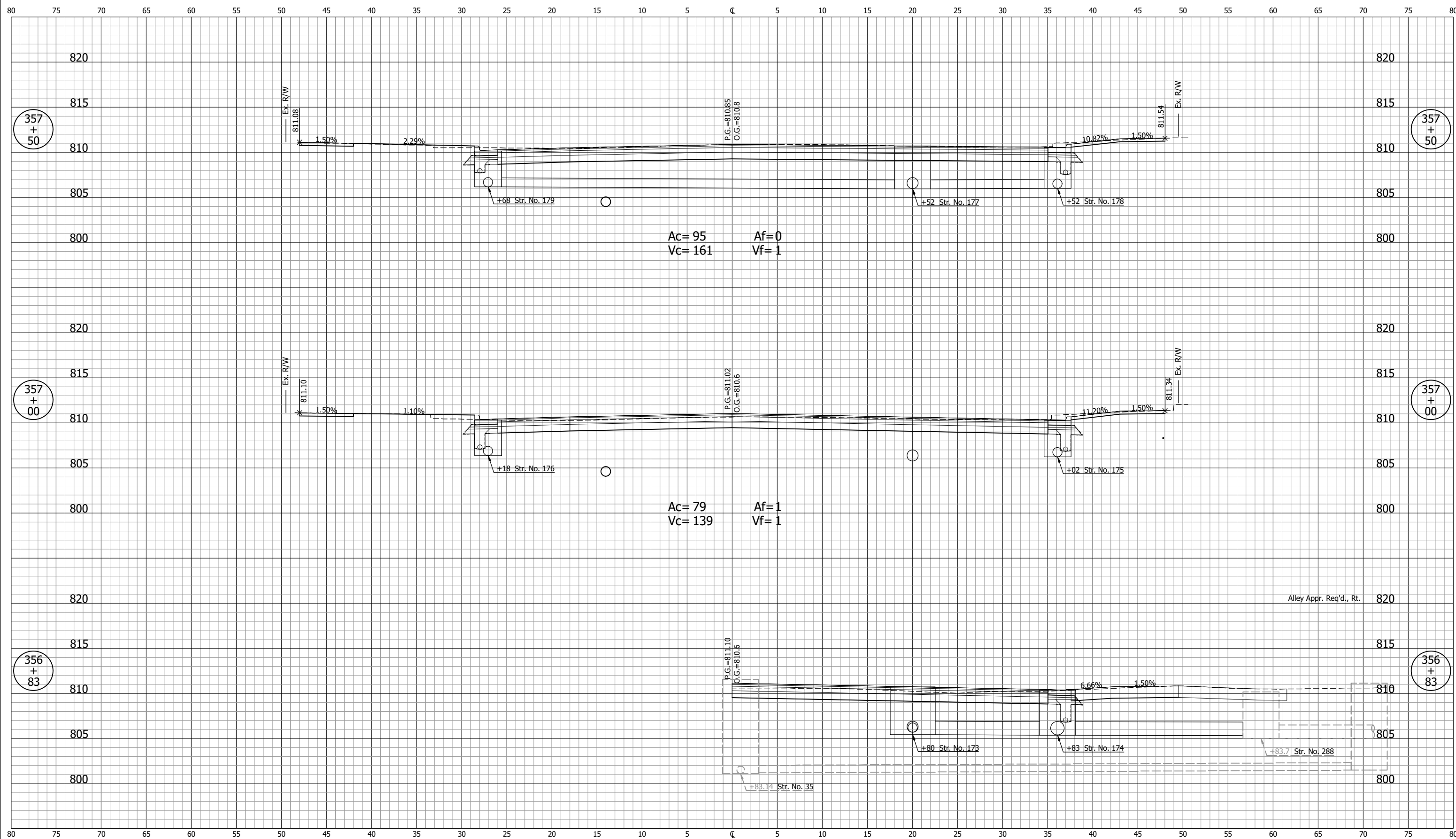

Alley Appr. Req'd., Rt.

NOT FOR CONSTRUCTION		INDIANA DEPARTMENT OF TRANSPORTATION		SCALE 1" = 5'	BRIDGE FILE
		CROSS SECTIONS LINE "B"		DESIGNATION 2001885 & 2101797	
SURVEY BOOK	SHEETS 355 of 357				
CONTRACT R-43382	PROJECT 2001885				

GDH - 2/9/2024 12:52 PM - U:\2021\202124 indot us35\Cad\C30\Design Files\212440D_C02.dwg (XS_79_B)

CROSS SECTIONS
Scale 1 inch = 5 feet

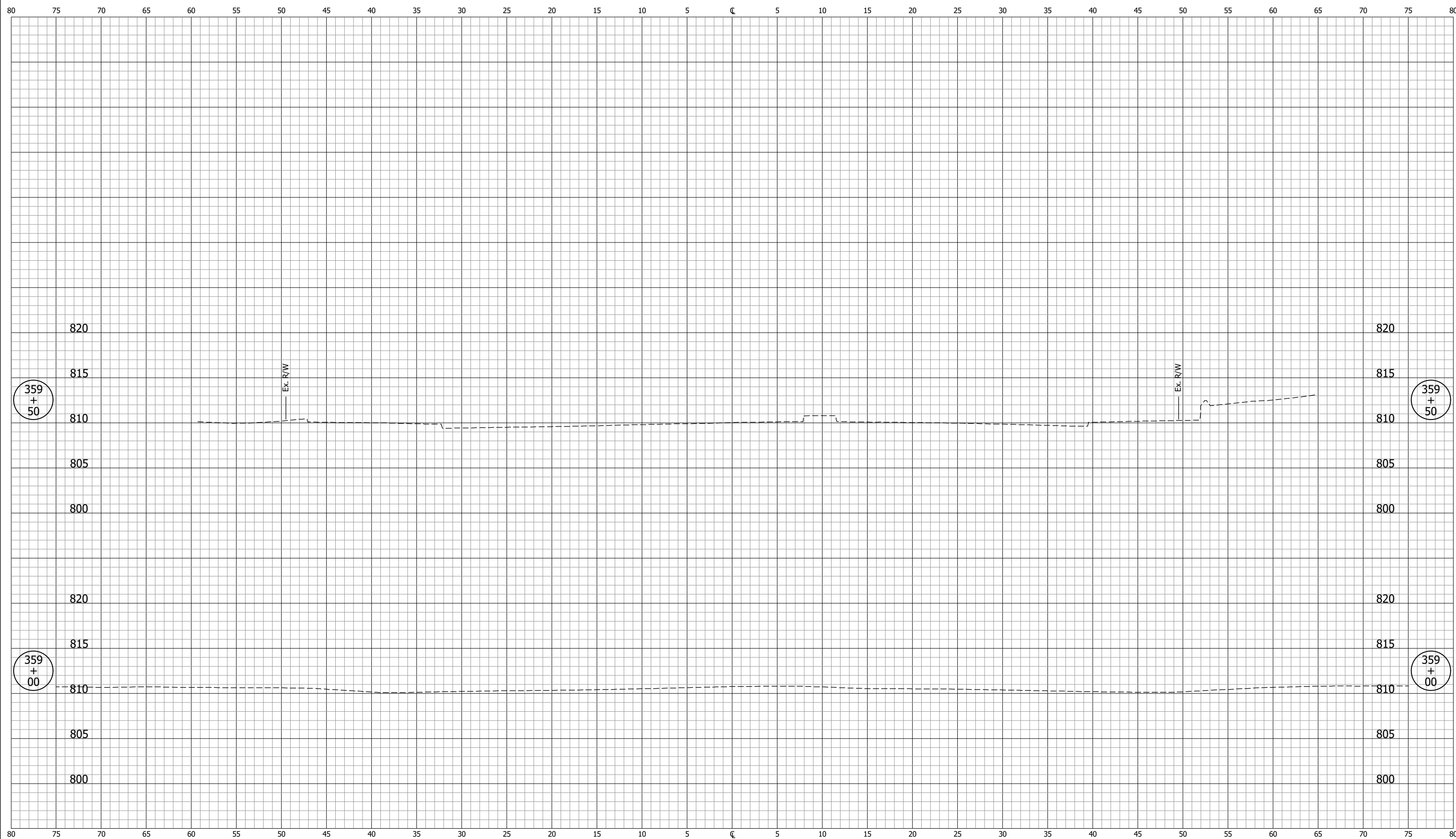

GDH - 2/9/2024 12:52 PM - U:\2021\202124 indot us35\Cad\C30\Design Files\212440D_C02.dwg (XS_81_B)

NOT FOR CONSTRUCTION		INDIANA DEPARTMENT OF TRANSPORTATION		SCALE 1" = 5'	BRIDGE FILE
DESIGNED: DGA		DRAWN: GDH		DESIGNATION 2001885 & 2101797	
CHECKED: DGD		CHECKED: DGA		SURVEY BOOK	SHEETS 357 of 357
		CROSS SECTIONS LINE "B"		CONTRACT R-43382	PROJECT 2001885