

Indiana Department of Transportation







CERTIFIED TECHNICIAN PROGRAM TRAINING MANUAL FOR **Construction Procedures** **Part I**

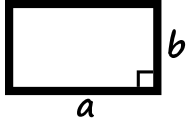
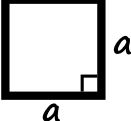

2024 Revision

MATH REFERENCES

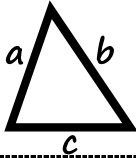
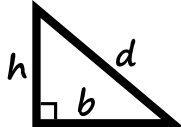
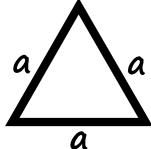
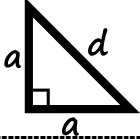
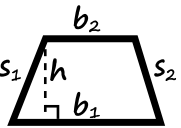
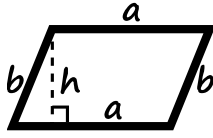
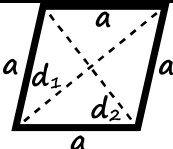
1 foot = 12 inches 1 square foot = 144 square inches 1 cubic foot = 1728 cubic inches
 3 feet = 1 yard 9 square feet = 1 square yard 27 cubic feet = 1 cubic yard
 5280 feet = Mile 1760 yards = 1 mile 1 acre = 4840 square yards

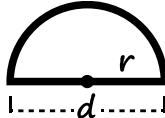
Rectangle		Square	
Perimeter	$2(a + b)$	Perimeter	$4a$
Area	$a \times b$	Area	a^2
Triangle		Triangle (any)	
Perimeter	$a + b + c$	Area by sides (no height)	$s = \frac{1}{2}(a + b + c)$
Area	$\frac{1}{2}(b \times h)$		$A = \sqrt{s(s - a)(s - b)(s - c)}$
Right Triangle		Equilateral Triangle	
Perimeter	$b + h + d$	Perimeter	$3a$
Area	$\frac{1}{2}(b \times h)$	Area	$\frac{\sqrt{3}}{4}a^2$
Isosceles Right Triangle		Trapezoid	
Perimeter	$2a + d$	Perimeter	$b_1 + b_2 + s_1 + s_2$
Area	$\frac{1}{2}a^2$	Area	$h \times \frac{b_1 + b_2}{2}$
Parallelogram		Rhombus	
Perimeter	$2(a + b)$	Perimeter	$4a$
Area	$a \times h$	Area	$\frac{d_1 \times d_2}{2}$
Circle		Semicircle	
Perimeter	$2\pi r$	Perimeter	$\pi r + 2r$
Area	πr^2	Area	$\frac{\pi r^2}{2}$

AREA OF A CIRCULAR SEGMENT

$$\text{Area} = C \times b \times \text{coefficient}$$

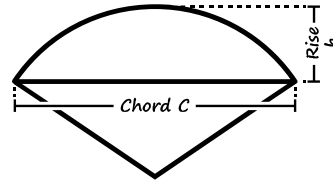

Coefficient	$\frac{b}{C}$
0.66667	0.00218
0.66668	0.00436
0.66669	0.00655
0.66671	0.00873
0.66673	0.01091
0.66676	0.01309
0.66679	0.01528
0.66683	0.01746
0.66687	0.01965
0.66692	0.02183
0.66697	0.02402
0.66703	0.02620
0.66710	0.02839
0.66717	0.03058
0.66724	0.03277
0.66732	0.03496
0.66740	0.03716
0.66749	0.03935
0.66759	0.04155
0.66769	0.04374
0.66779	0.04594
0.66790	0.04814
0.66802	0.05035
0.66814	0.05255
0.66826	0.05476
0.66839	0.05697
0.66853	0.05918
0.66867	0.06139
0.66882	0.06361
0.66897	0.06583
0.66913	0.06805
0.66929	0.07027
0.66946	0.07250
0.66964	0.07473
0.66981	0.07696
0.67000	0.07919
0.67019	0.08143
0.67039	0.08367
0.67059	0.08592
0.67079	0.08816
0.67101	0.09041
0.67122	0.09267
0.67145	0.09493
0.67168	0.09719
0.67191	0.09946

Coefficient	$\frac{b}{C}$
0.67215	0.10173
0.67240	0.10400
0.67265	0.10628
0.67291	0.10856
0.67317	0.11085
0.67344	0.11314
0.67372	0.11543
0.67400	0.11773
0.67429	0.12004
0.67458	0.12235
0.67488	0.12466
0.67519	0.12698
0.67550	0.12931
0.67582	0.13164
0.67614	0.13397
0.67647	0.13632
0.67681	0.13866
0.67715	0.14101
0.67750	0.14337
0.67786	0.14574
0.67822	0.14811
0.67859	0.15048
0.67897	0.15287
0.67935	0.15525
0.67974	0.15765
0.68014	0.16005
0.68054	0.16246
0.68095	0.16488
0.68136	0.16730
0.68179	0.16973
0.68222	0.17216
0.68265	0.17461
0.68310	0.17706
0.68355	0.17952
0.68401	0.18199
0.68448	0.18446
0.68495	0.18694
0.68543	0.18943
0.68592	0.19193
0.68642	0.19444
0.68692	0.19696
0.68743	0.19948
0.68795	0.20201
0.68848	0.20456
0.68901	0.20711

Coefficient	$\frac{b}{C}$
0.68956	0.20967
0.69011	0.21224
0.69067	0.21482
0.69123	0.21741
0.69181	0.22001
0.69239	0.22261
0.69299	0.22523
0.69359	0.22786
0.69420	0.23050
0.69482	0.23315
0.69545	0.23582
0.69608	0.23849
0.69673	0.24117
0.69738	0.24387
0.69805	0.24657
0.69872	0.24929
0.69941	0.25202
0.70010	0.25476
0.70080	0.25752
0.70151	0.26028
0.70223	0.26306
0.70297	0.26585
0.70371	0.26866
0.70446	0.27148
0.70522	0.27431
0.70600	0.27715
0.70678	0.28001
0.70758	0.28289
0.70838	0.28577
0.70920	0.28868
0.71003	0.29159
0.71087	0.29452
0.71172	0.29747
0.71258	0.30043
0.71345	0.30341
0.71434	0.30640
0.71524	0.30941
0.71615	0.31243
0.71707	0.31548
0.71800	0.31854
0.71895	0.32161
0.71991	0.32470
0.72088	0.32781
0.72187	0.33094
0.72287	0.33409

Coefficient	$\frac{b}{C}$
0.72388	0.33725
0.72491	0.34044
0.72595	0.34364
0.72701	0.34686
0.72808	0.35010
0.72916	0.35337
0.73026	0.35665
0.73137	0.35995
0.73250	0.36327
0.73364	0.36662
0.73480	0.36998
0.73598	0.37337
0.73717	0.37678
0.73838	0.38021
0.73960	0.38366
0.74084	0.38714
0.74210	0.39064
0.74337	0.39417
0.74466	0.39772
0.74597	0.40129
0.74730	0.40489
0.74865	0.40852
0.75001	0.41217
0.75140	0.41585
0.75280	0.41955
0.75422	0.42328
0.75566	0.42704
0.75713	0.43083
0.75861	0.43464
0.76011	0.43849
0.76164	0.44236
0.76318	0.44627
0.76475	0.45020
0.76634	0.45417
0.76795	0.45817
0.76959	0.46220
0.77125	0.46626
0.77293	0.47035
0.77463	0.47448
0.77636	0.47865
0.77812	0.48284
0.77990	0.48708
0.78171	0.49135
0.78354	0.49566
0.78540	0.50000

MANUAL DISCLAIMER

The references in this manual are reflective of the 2022 INDOT Standard Specifications. The material covered herein is for training purposes only. The Standard Specifications, Contract Information Book, General Instruction to Field Employees, and Construction Memos should be consulted for determining the current inspection procedures for a given contract. On-site procedures, field tests, and other operating procedures may vary from those described within this manual.

TABLE OF CONTENTS

CHAPTER ONE: INTRODUCTION.....	1-1
GENERAL DEFINITIONS.....	1-1
Polygon	1-1
Triangle	1-1
Right Triangle	1-1
Isosceles Triangle.....	1-1
Equilateral Triangle.....	1-1
Oblique Triangle	1-1
Congruent Triangles.....	1-1
Similar Triangles.....	1-1
Rectangle	1-2
Trapezoid	1-2
Circle.....	1-2
Perimeter	1-2
Radius.....	1-2
Chord.....	1-2
Diameter	1-2
Arc.....	1-2
Segment	1-2
AREA DEFINITIONS	1-2
Area of a Rectangle.....	1-2
Area of a triangle.....	1-3
Area of a Triangle with Known Sides	1-3
Area of a Trapezoid.....	1-3
Area of a Circle.....	1-3
Area of a Circular Segment using Rise and Chord.....	1-4
Composite Areas.....	1-4
ACCURACY OF CALCULATIONS	1-4
Rounding.....	1-4
Degree of Accuracy	1-4
Exceptions	1-5

CHAPTER TWO: HISTORICAL SURVEYING	2-1
DEFINITIONS.....	2-1
<i>Elevation</i>	2-1
<i>Mean Sea Level</i>	2-1
<i>Benchmark</i>	2-1
<i>Temporary Benchmark</i>	2-1
<i>Vertical Control</i>	2-1
<i>Leveling</i>	2-1
<i>Level Circuit</i>	2-2
<i>Turning Point</i>	2-2
<i>Backsight</i>	2-2
<i>Foresight</i>	2-2
<i>Height Of Instrument</i>	2-2
EQUIPMENT	2-2
<i>Plumb Bob</i>	2-2
<i>Theodolite</i>	2-3
<i>Level</i>	2-3
<i>Leveling Rod</i>	2-4
<i>Chains and Tapes</i>	2-4
<i>Level Run Procedure</i>	2-4
<i>Distance Measurements</i>	2-5
CHAPTER THREE: MODERN SURVEYING AND MEASURING.....	3-1
SURVEYING EQUIPMENT	3-1
<i>Robotic Total Station</i>	3-1
<i>Scanning Total Station</i>	3-1
<i>Self-Leveling Level</i>	3-1
INCORS	3-2
TAPE MEASURES.....	3-2
<i>Pocket Tape</i>	3-2
<i>Cloth Tape</i>	3-2
<i>Laser Tape</i>	3-3
<i>Measuring Wheel</i>	3-3
CHAPTER FOUR: DAILY REPORTING.....	4-1
FIELD ASSISTANT	4-1
<i>Crew</i>	4-1
<i>Equipment</i>	4-1
<i>Remarks</i>	4-1
<i>Work Items</i>	4-3
SITEMANAGER DWR	4-4
<i>Dwr Info</i>	4-4
<i>Contractors</i>	4-5
<i>Contractor Equipment</i>	4-5
<i>Work Items</i>	4-5

ADDITIONAL RESOURCES	4-5
CHAPTER FIVE: CROSS SECTIONS	5-1
SIDE SLOPES	5-1
ORIGINAL CROSS SECTIONS	5-2
PROFILES	5-2
ZERO SECTION	5-2
SPLIT SECTION	5-3
MATCH LINES	5-3
INTERPOLATION	5-3
EARTHWORK QUANTITIES	5-4
CHAPTER SIX: SLOPE STAKES	6-1
DEFINITIONS.....	6-1
<i>Control Point</i>	6-1
<i>Grade Rod</i>	6-1
<i>Ground Rod</i>	6-1
<i>Reading Slope Stakes</i>	6-2
CHAPTER SEVEN: RADIUS POINTS	7-1
LAYING OUT RADIUS POINTS FOR DRIVES/APPROACHES.....	7-1
<i>Layouts for Square Drives/Approaches</i>	7-1
<i>Layouts for Skew Drives/Approaches</i>	7-1
APPLICATION OF DRIVES AND APPROACHES	7-3
<i>Turn Lanes</i>	7-3
<i>Driveways</i>	7-3
<i>Mailbox Approaches</i>	7-3
CHAPTER EIGHT: PIPE STRUCTURES.....	8-1
PIPE TYPES.....	8-1
PIPE END TREATMENTS.....	8-1
<i>Grated Box End Section</i>	8-1
STRUCTURE DATA TABLE	8-2
BASIS OF USE FOR PIPE MATERIALS	8-2
<i>Metal Pipe</i>	8-2
<i>Concrete Pipe</i>	8-2
<i>Plastic Pipe</i>	8-2
<i>Metal Pipe End</i>	8-2
<i>Safety Metal End Section</i>	8-3
<i>Other Items</i>	8-3
<i>Recording Tags For Basis of Use</i>	8-3
<i>Multi-Plate Pipe</i>	8-3
<i>Miscellaneous Concrete</i>	8-3
<i>Recording Tags for Future Use</i>	8-3

CHAPTER NINE: PIPE PLACEMENT	9-1
EXCAVATION	9-1
<i>Rock Excavation.....</i>	<i>9-1</i>
<i>Unsuitable Material</i>	<i>9-1</i>
<i>Excess Excavation Payment.....</i>	<i>9-1</i>
<i>Removal Of Existing Structures</i>	<i>9-1</i>
<i>Safety.....</i>	<i>9-2</i>
LAYING PIPE	9-2
<i>Structure Bearing</i>	<i>9-2</i>
<i>Laying Concrete or Clay Bell Pipe</i>	<i>9-2</i>
<i>ABS Pipe</i>	<i>9-2</i>
<i>Metal Pipe.....</i>	<i>9-2</i>
<i>Multi-Plate Pipe.....</i>	<i>9-2</i>
JOINING PIPE WITH COLLARS.....	9-3
STUB-TEE CONNECTIONS	9-3
<i>Metal Pipe.....</i>	<i>9-3</i>
<i>Concrete Pipe.....</i>	<i>9-3</i>
PIPE END TREATMENTS.....	9-3
<i>Pipe Anchors</i>	<i>9-3</i>
<i>Pipe End Sections.....</i>	<i>9-3</i>
<i>Grated Box End Sections and Safety Metal End Sections</i>	<i>9-4</i>
CHAPTER TEN: MEASUREMENT OF PIPE ITEMS.....	10-1
PIPE MEASUREMENT	10-1
<i>Tees, Stub-Tees, and Wyes</i>	<i>10-1</i>
<i>Elbows</i>	<i>10-1</i>
<i>Other Connections.....</i>	<i>10-1</i>
<i>Anchors</i>	<i>10-1</i>
<i>Pipe End Sections and Safety Metal End Sections.....</i>	<i>10-1</i>
<i>Grated Box End Sections.....</i>	<i>10-1</i>
COMPUTING STRUCTURE LENGTH USING ELBOWS.....	10-1
CHAPTER ELEVEN: MANHOLES, INLETS, AND CATCH BASINS	11-1
STRUCTURE	11-1
METHODS OF CONSTRUCTION	11-1
MATERIAL REQUIREMENTS.....	11-1
<i>Concrete</i>	<i>11-1</i>
<i>Brick or Block</i>	<i>11-1</i>
STRUCTURES IN PAVEMENT AREA.....	11-2
HOODS FOR CATCH BASINS	11-2
MORTAR MIXTURE	11-2
PRECAST STRUCTURE OPENINGS	11-2
STRUCTURE JOINTS.....	11-2

ADJUSTMENTS.....	11-2
GRADE ADJUSTMENT TO EXISTING STRUCTURES	11-2
<i>Adjusting Existing Structures</i>	11-2
<i>Replacing Castings</i>	11-3
<i>Reconstructed Structures</i>	11-3
<i>Castings in Pavement Area</i>	11-3
<i>Adjustment on Resurface Contracts</i>	11-3
MANHOLE, INLETS, AND CATCH BASINS	11-3
<i>Basis of Payment</i>	11-3
<i>Miscellaneous Requirements</i>	11-3
CHAPTER TWELVE: PIPE AND STRUCTURE BACKFILL	12-1
BACKFILL LIMITS.....	12-1
BASIS OF USE	12-1
BACKFILL METHODS	12-1
TRENCH DETAILS.....	12-1
ROCK	12-1
BEDDING DETAILS	12-2
BACKFILL PLACEMENT.....	12-2
<i>Method 1 Backfill</i>	12-2
<i>Method 2 Backfill</i>	12-2
<i>Other Backfill</i>	12-2
<i>Outside Backfill Specified Limits</i>	12-3
COVER LIMITS.....	12-3
<i>Ramps Over Structure For Protection</i>	12-3
LIMITATIONS	12-3
PAYMENT FOR BACKFILL	12-3
<i>Structure Backfill</i>	12-3
<i>Flowable Backfill</i>	12-3
CHAPTER THIRTEEN: RELINING EXISTING PIPE STRUCTURES.....	13-4
SLIP LINING ROADWAY CULVERTS WITH POLYETHYLENE CULVERT PIPE	13-4
<i>Materials</i>	13-4
<i>Equipment</i>	13-6
<i>Right of Entries</i>	13-6
<i>Construction Requirements</i>	13-6
JACKED PIPE	13-7
<i>Construction Requirements</i>	13-7
<i>Jacking</i>	13-7
<i>Boring</i>	13-8
<i>Jacking Concrete Pipe</i>	13-8
<i>Jacking Steel Pipe</i>	13-1

CHAPTER FOURTEEN: MULTI-PLATE PIPE14-2
PLATES 14-2
BOLTS 14-3
NUTS 14-3
PLATE IDENTIFICATION AND LOCATION 14-4
PIPE-ARCH ASSEMBLY 14-4
BOLTING 14-5

CHAPTER ONE: INTRODUCTION

This introduction is intended to improve the Technician's ability to solve problems and to do various calculations required in construction layout and determining pay quantities.

GENERAL DEFINITIONS

Before there is any discussion of construction layout and measurements, there needs to be an understanding of the definitions of the generally used figures in this process.

POLYGON

A polygon is a closed figure bounded by straight lines lying in the same plane.

The sum S of the interior angles of a closed polygon is calculated as:

$$S = (N - 2) \times 180^\circ$$

where:

N = number of sides

Thus, the sum of the interior angles of a triangle is 180° , a rectangle is 360° , a five-sided figure is 540° , and so on.

TRIANGLE

A polygon of three sides.

RIGHT TRIANGLE

A triangle which has one right angle (90°).

ISOSCELES TRIANGLE

A triangle which has two equal sides and two equal angles.

EQUILATERAL TRIANGLE

A triangle which has three equal sides and three equal angles.

OBLIQUE TRIANGLE

A triangle which has no right angle and no equal sides.

CONGRUENT TRIANGLES

Two triangles are *congruent* if their corresponding sides and corresponding angles are equal. Congruent triangles have the same area. Triangles abc and def in Figure 1-1 are congruent.

SIMILAR TRIANGLES

Two triangles are *similar* if their corresponding angles are equal and their corresponding sides are proportional. Similar triangles may have different areas and rotation, but with one larger or smaller than the other, as shown in Figure 1-2.

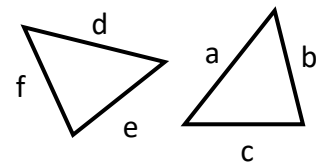

Figure 1-1 Congruent Triangles
 $a = d$, $b = e$ and $c = f$

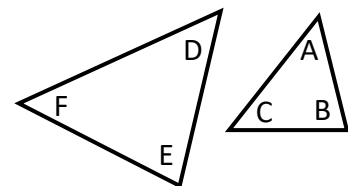

Figure 1-2 Similar Triangles
 $\angle A = \angle D$, $\angle B = \angle E$ and $\angle C = \angle F$

RECTANGLE

A four-sided polygon with four right angles. A *square* is a rectangle with equal sides.

TRAPEZOID

A four-sided polygon which has two parallel sides and two non-parallel sides.

CIRCLE

An enclosed curve on a plane whose perimeter points are equidistant from center. (Figure 1-3)

PERIMETER

The boundary (outer limits) of a closed area. The perimeter of a circle is its *circumference*. (Figure 1-3a)

RADIUS

The distance from the center of the circle to any point on its perimeter. (Figure 1-3b)

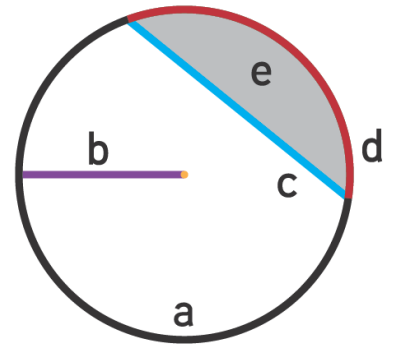

Figure 1-3 Parts of a Circle
a – circumference, b – radius
c – chord, d – arc, e – segment

CHORD

A straight line between any two points on the perimeter of a circle. (Figure 1-3c)

DIAMETER

A chord that passes through the center of the circle. The diameter is twice the radius.

ARC

A section of a circumference measured from one point to another. (Figure 1-3d)

SEGMENT

The area enclosed within any arc of a circle when the two endpoints are joined. (Figure 1-3e)

A *semi-circle* is half a circle, or a *segment made using a diameter and the arc it creates*.

AREA DEFINITIONS

Area is the surface within a set of lines. Area is measured in square units, square inches, square feet, square miles, etc.

AREA OF A RECTANGLE

The area A of a rectangle is equal to the product of the length and the width.

$$A = L \times W$$

where:

L = length of rectangle

W = width of rectangle

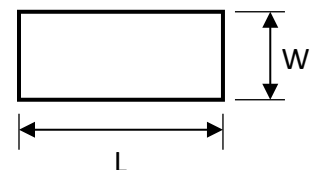

AREA OF A TRIANGLE

The area of a triangle is expressed in terms of its base and altitude. Any side of a triangle may be called the base. The altitude is the perpendicular distance from the base to the vertex opposing the base.

An angle is defined as *the space between two lines diverging from a common point* – this point is called the vertex. The area A of any triangle is:

$$A = \frac{1}{2}B \times H$$

where:

B = base length

H = altitude length

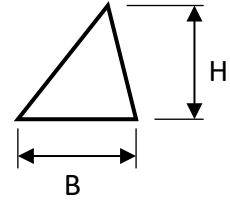

The area of a *right triangle* is calculated in the same manner.

AREA OF A TRIANGLE WITH KNOWN SIDES

If the length of the three sides of a triangle are known, the area A may be calculated from:

$$A = \sqrt{s(s - a)(s - b)(s - c)}$$

where:

a = length of side a

b = length of side b

c = length of side c

$$s = \frac{1}{2}(a + b + c)$$

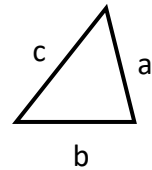

AREA OF A TRAPEZOID

The area A of a trapezoid is equal to the average width times the altitude.

$$A = \frac{B_1 + B_2}{2} \times H$$

where:

B_1 = length of Base 1

B_2 = length of Base 2

H = altitude height

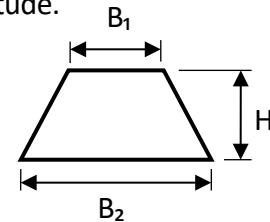

Expressed in another way, the area is the sum of the bases, divided by two, times the height.

AREA OF A CIRCLE

The area A of a circle is π times the square of its radius.

$$A = \pi r^2$$

where:

π = a constant, generally given as 3.14 or 3.14159

r = the radius of the circle

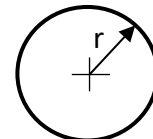

AREA OF A CIRCULAR SEGMENT USING RISE AND CHORD

The area *A* of a circular segment is determined by multiplying the chord length and rise by a coefficient from the *Area of a Circular Segment* table above. The formula is as follows:

$$A = c \times b \times C$$

where:

c = chord length

b = rise

C = Coefficient from table

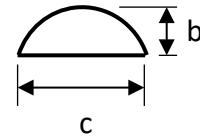

COMPOSITE AREAS

Irregular shaped areas may be divided into components and then the areas calculated. This method is very helpful where the technician is measuring sod, concrete driveways, etc.

ACCURACY OF CALCULATIONS

ROUNDING

When calculations are conducted, rounding is required to be in accordance with Section 109.01(a) using the standard 5-up procedure. There are two rules for rounding numbers:

1. When the first digit discarded is less than 5, the last digit retained should not be changed:
 - 2.4 rounds to 2
 - 2.43 rounds to 2.4
 - 2.434 rounds to 2.43
 - 2.4321 rounds to 2.434

2. When the first digit discarded is 5 or greater, the last digit retained should be increased by one unit:
 - 2.6 rounds to 3
 - 2.56 rounds to 2.6
 - 2.416 rounds to 2.42
 - 2.4157 rounds to 2.416

DEGREE OF ACCURACY

The degree of accuracy is defined as *how precise a number needs to be, reliably*. INDOT Spec bases the degree of accuracy on the dollar value per the item’s Unit of Measure – for example, EA, SQ YD, or LFT. Items that are more expensive therefore have higher accuracy requirements. While all measurements are made to the nearest first decimal place (0.1), calculations and final pay quantity degrees of accuracy are as follows:

Unit Price	Degree of Accuracy specified for:		
	Field Measurement	Calculation Results & Subtotals	Final Pay Quantity
\$ 0 - 9.99	0.1 unit	0.1 unit	1 unit
\$ 10 - 99.99	0.1 unit	0.01 unit	0.1 unit
\$ 100 - 999	0.1 unit	0.01 unit	0.01 unit
\$ 1000+	0.1 unit	0.001 unit	0.001 unit

EXCEPTIONS

- Weigh tickets are considered original notes for many items and are required to be measured to the nearest 100 pounds
- Pavement striping and pipe (except concrete pipe) is measured and calculated to the nearest one foot. The Specifications for concrete pipe should be checked to determine the measurement units
- Seed is weighed to the nearest one pound
- Fertilizer is weighed to the nearest one hundredth ton or 10 pounds
- Items whose proposal unit is listed as "each" or "lump sum" are measured or counted to that whole unit
- Linear grading is field measured to the nearest 0.001% of the unit, with calculations, sub totals, and final pay quantities as shown in the accuracy table
- Field measurements, calculations, sub totals and final pay quantity on herbicide contracts are made to the nearest one unit

CHAPTER TWO: *HISTORICAL SURVEYING*

Surveying, as a practice, dates back to ancient Egypt, where surveying was used to lay out construction, using ropes and plumb bobs for measurement. There have been many advancements throughout history, from the invention of the magnetic compass in China around 200 BC, to the first recorded land plots in 11th century England, the invention of the theodolite and dumpy levels in the 1700s & 1800s, to modern GPS and LiDAR instruments used today. This chapter covers equipment used by surveyors in the late 1900s and early 2000s.

DEFINITIONS

ELEVATION

A point of vertical control is known as an elevation. Elevations are measured to a reference which is usually mean sea-level so that a point having an elevation of 722.95 ft means that the particular point is 722.95 ft above sea-level. Sometimes in paving or in roadwork an elevation is referred to as a grade.

MEAN SEA LEVEL

The height of the sea surface averaged over all stages of the tide over a long period of time

BENCHMARK

A benchmark, or *BM*, is a definite point on a permanent object which has a known elevation and a known location. A benchmark is a point of reference which is convenient for leveling in a given locality. The relation to sea-level is very precise and obtained by running a level circuit such that the elevation of the beginning and the end of the circuit are known and tied together.

TEMPORARY BENCHMARK

Temporary benchmarks, or *TBM*s, are used supplement permanent benchmarks. They help provide temporary convenient access to a known elevation, and they are usually removed at the end of a project.

VERTICAL CONTROL

A point of vertical control is known as an elevation.

LEVELING

In highway surveying, leveling is done to provide the necessary vertical control to construct a highway or a bridge. Differential leveling is the operation of determining the elevations of points some distance apart. This is the method used in highway surveying to establish the necessary vertical control for construction. Historically, this procedure is done by differential leveling. Differential leveling requires a series of set-ups of the instrument along the general route. For each set-up, a rod-reading back to the point of known elevation and then forward to a point of unknown elevation is taken. One use of differential leveling is the level circuit.

LEVEL CIRCUIT

A level circuit involves a survey crew using a permanent or temporary benchmark to determine the elevation of another point. Below describes the various points in the circuit and how they are used to determine the elevation of the object in question.

TURNING POINT

A turning point, or *TP*, is an intermediate point between benchmarks which provides a temporary point of known elevation for a level circuit between two benchmarks a long distance apart. A turning point may be an iron pin which is driven firmly into the ground at a convenient location. Rod readings are taken on the pin before an instrument is advanced and again as the initial rod readings are taken before the instrument has been re-established ahead on the circuit. After the second reading, the pin is pulled and carried ahead. A turning point may be an existing convenient object upon which a rod reading may be taken; however, the object is required to be solid, stable, and not move or change in elevation for the few minutes needed between set-ups. A permanent or temporary benchmark may be used as a turning point.

BACKSIGHT

A backsight, or *BS*, is a rod reading taken at a point of known elevation, such as a benchmark or turning point. Another term for backsight is plus sight.

FORESIGHT

A foresight, or *FS*, is a rod reading taken on a point for which the elevation is to be established. A foresight is sometimes called a minus sight.

HEIGHT OF INSTRUMENT

The height of instrument (HI) is the elevation of the line of sight of the center of the cross-hairs in the telescope when the instrument is properly leveled. The height of instrument is equal to the elevation of the benchmark sighted plus the rod reading taken on the benchmark. In mathematical terms this may be written as follows:

$$H_I = BM_e + BM_s$$

where:

H_I = Height of Instrument

BM_e = Benchmark elevation (rod reading)

BM_s = Benchmark (sighted)

The precision of work done with these instruments is excellent to approximately 200 ft.

EQUIPMENT

PLUMB BOB

The plumb bob dates back to ancient Egypt and can still be purchased at your local hardware store today. It consists of a weight with a point on its end attached to a string, as shown in Figure 2-1. It is used to find a point on the ground directly below another object.



Figure 2-1 Plumb Bob

THEODOLITE

Theodolites (Figure 2-2) are used to measure both vertical and horizontal angles. A surveyor looks through a telescope that can be adjusted to point directly at a point in the distance. Originally, they would have used printed gauges that a surveyor would have to interpret and record, but these eventually transitioned to providing digital readouts for simplicity. Transits are theodolites with a telescope that can rotate on the vertical plane to allow backsights to be taken.

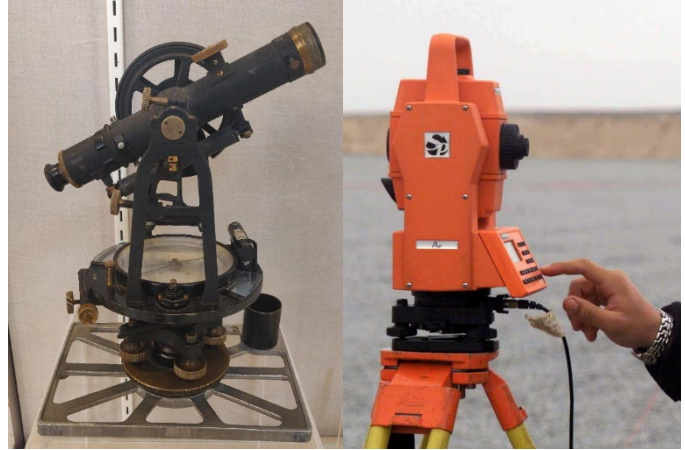

Figure 2-3 Two Transit-type Theodolites

LEVEL

The level is an instrument used to determine and establish elevations and differences in elevation between points. It contains a telescope that the surveyor will look through toward a rod in the distance to determine the elevation difference between two points.



Figure 2-2 Dumpy Level

An old type of level is the dumpy level (Figure 2-3). While similar to the self-leveling level, the telescope has no self-correcting attributes and is less accurate.

The most common type of level used by INDOT is the self-leveling level shown in Figure 2-4. The telescope (1) has the usual eyepiece system, objective lens, focusing mechanism, and reticle with cross lines. Also, there are three leveling screws at the base (3), and the instrument is supported on a tripod. The head (4), which encloses the tops of the leveling screws,



Figure 2-4 Self-Leveling Level

1) Telescope; 2) Viewing Prism; 3) Leveling Screws; 4) Head

may be leveled by means of these screws. To enable the operator to determine when the head is level, there is a circular level vial, which may be viewed through the window (2). With this bubble in position, the level may be turned and will stay the level allowing the operator to look horizontally at the target through the telescope. There is a hanging prism in the body to aid making the level more accurate. These have evolved over the years to include digital components that allow automatic reading of special rods and are still used today.

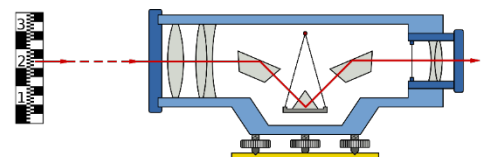

Figure 2-5 Internal Diagram of Self-Leveling Level

LEVELING ROD

Used in conjunction with the level, the second most important piece of equipment needed for differential leveling is the leveling rod. Several types of leveling rods are used in highway construction. The Chicago Rod and the Philadelphia Rod are the two types which are generally preferred. The Chicago Rod is a slip-joint rod which has a total length of 12 ½ ft when all sections are used. The Philadelphia Rod is a sliding joint type of rod that extends to 15 or 16 ft and is a more convenient rod when using a target. Selection of a rod type is a matter of personal preference or availability. More recent rods have a barcode like image on one side to allow for the instruments to digitally read the rod.

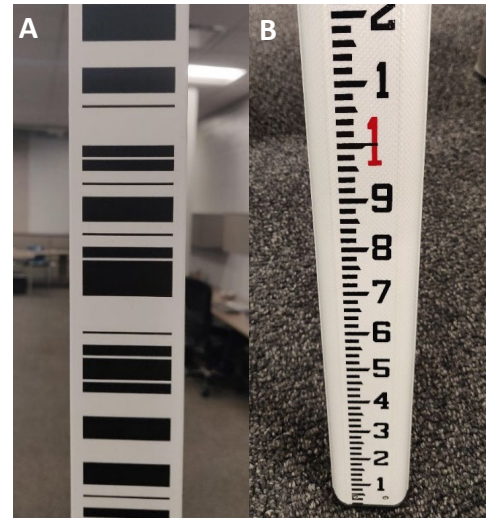

Figure 2-6 Leveling Rods
a) Digital Barcode; b) Philadelphia

CHAINS AND TAPES

One common method of determining distance is by direct measurement with a tape. The steel tape is usually 100 ft in length. The term "chain" comes from the Gunter's Chain (Figure 2-7) which was sixty-six feet long and was composed of 100 links, each being 7.92 inches long. Brass tags were fastened at each ten links and notches in the tags indicated the number of ten link segments between the tag and the end of the tape. Therefore, the early tapes looked like a chain of one hundred links. Chain is also applied to the operation of measuring lines with tapes. The term "taping" is gradually being used more exclusively.



Figure 2-7 Gunter's Chain

The distance measured with a steel tape (Figure 2-8) is much more precise than the distance obtained by pacing. The precision obtained depends upon the degree of refinement with which the measurements are taken. Ordinarily, taping over flat, smooth ground with a steel tape or chain, divided in hundredths of a foot, provides a precision of one in three thousand to one in five thousand.



Figure 2-8 Steel Tape

LEVEL RUN PROCEDURE

1. Set up the level part way to the desired point from the benchmark and level the instrument properly.
2. The rodman sets the rod on the BM and rocks the rod on this point. The instrument operator reads the rod for the backsight, making sure that the rod is at the center of the cross hairs and that the level bubble is truly centered when the reading is taken.

3. The rodman moves up to the first turning point, sets the rod on the stake, and rocks the rod as the instrument operator turns the instrument to obtain a precise reading of the rod at the first turning point. Once again, the bubble level is centered when the reading is taken. The instrument operator reads the rod for the foresight toward the turning point. This is the first set-up.
4. The level is then moved to a new location past the turning point and toward the point where the elevation is needed. Like in step 2, The rodman sets the rod on the turning point and rocks the rod. The instrument operator reads the rod.
5. The crew will continue the pattern until the point in question is reached.

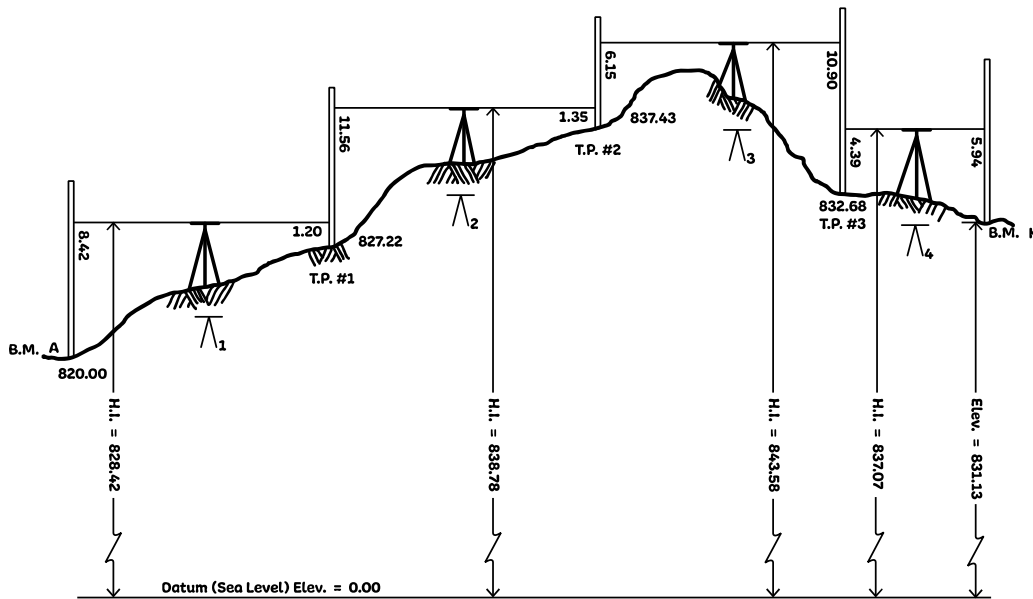

Figure 2-9 Level Set-up

DISTANCE MEASUREMENTS

In surveying, the distance between two points is understood to mean the horizontal distance, regardless of the relative elevation of the two points. Frequently, the lay of the land between the two points is not uniform, or the elevation of the two points is very different. Special equipment and techniques may be needed to obtain an accurate determination of the distance. Various methods of determining distance are available along with special and different types of equipment. The degree of precision required is another factor which is required to be considered before a measurement of distance is undertaken so that the correct type of equipment and method of measurement may be done.

PACING

Pacing is a rapid means of approximately checking more precise measurements of distance. Pacing over rough country may be done with a precision of one in one hundred. In average conditions, a person with some experience should have little difficulty in pacing with a precision of one in two hundred. Obviously, there is not much precision in this method and the procedure provides only an approximation of distance. The natural pace of each individual normally varies from 2 ½ to 3 ft. A convenient relation between the pace and the foot is 40 paces approximately equal 100 ft. Technicians involved in surveying standardize their pace by walking over known distances on level, sloping, and uneven ground. Pacing should never be used to determine official measurements.

TAPING

There is a formal procedure to be followed in measuring the distance between two points. Presented below is a simplified version of the procedure. The person moving ahead or away from the instrument is called the head chainman. The head chainman takes the zero end of the tape or the end of the tape with the graduated foot, and moves on the line toward the distance point. The person remaining behind to hold the end of the tape on the last established point of beginning is called the rear chainman. During this time, the rear chainman is responsible for keeping the head chainman on line and to make sure the tape does not snag or kink which could result in damage to the tape. As the hundred foot end of the tape reaches the rear chainman, he should call ahead to the head chainman to tell him he has gone far enough.

The next step requires a general lining-in procedure and a check to make sure that the tape is straight, not twisted. Obviously, the graduations on the face of the tape should be up at both ends. When the tape is straight and on line the rear chainman holds the 100 ft mark on the established point.

The head pulls the tape taut with the tension indicated by the tape's manufacturer (typically around 15 pounds). The stake or pin are held upright with the zero mark of the tape centered and low on the stake or pin. The instrument operator tells the head chainman to move the stake left or right to come precisely on line. When the instrument operator indicates the stake is exactly on line and the rear chainman calls that all is good, the head chainman sets the pin or begins to drive the stake. When the stake is solidly set, at least $\frac{3}{4}$ of the length in the ground, the top of the stake is marked for line and distance. A point is then established on the stake by the head chainman. A check of the point is made, and the head chainman takes the zero end of the tape, moves forward as before, and repeats the process.

If an odd distance is to be measured between two points, the head chainman holds the zero end of the tape approximately on the forward point. The rear chainman pulls the tape somewhat taut and checks to see where the rear point intersects the tape. The tape is then pulled so that the smaller graduation of the tape is on the point, and then this number is called out to the head chainman. The head chainman then pulls the tape with the proper tension and reads the fine division of the extra foot on the tape. The graduation held by the rear chainman on the new point added to the graduation read by the head chainman on the forward point gives the measurement between the two points in hundredths of a foot.

EXAMPLE

1. The distance between two stakes is less than 100 ft
2. The tape is pulled so that the head chainman is holding zero very close to the forward point, and the rear chainman pulls the tape and finds that the point is between the 63 and 64 graduations on the tape
3. The rear chainman then pulls the tape and holds the 63 mark on the rear point
4. The rear chainman then calls to the head chainman saying HOLDING 63
5. Both chainmen check to make sure the tape is straight, not twisted, and pulled taut
6. The head chainman reads 0.58 on the extra foot
7. The distance between the two points is 63.58 ft

Breaking tape is the measurement of a line when increments less than 100 ft are measured due to the roughness of the terrain. The tape does the adding of the increments to 100 ft. This is done by having the head chainman pull the zero end of the tape completely along the line down the rugged slope until the 100 ft mark is even with the rear chainman. The tape is left lying on the line in this fashion. With the rear chainman holding the 100 ft mark on the rear point, the head chainman backs up on the tape to a graduation which he can plumb comfortably and under which a stake may be set accurately. He proceeds to plumb, line and place the stake at this point on the line. This procedure is repeated until 100 ft are measured. The tape is not moved ahead until the zero mark is reached. The rear chainman occupies the mark that is just vacated by the head chainman as he moves ahead on the line and down the slope. Figure 2-10 shows how horizontal measurements are obtained on steep slopes by the process of breaking tape.

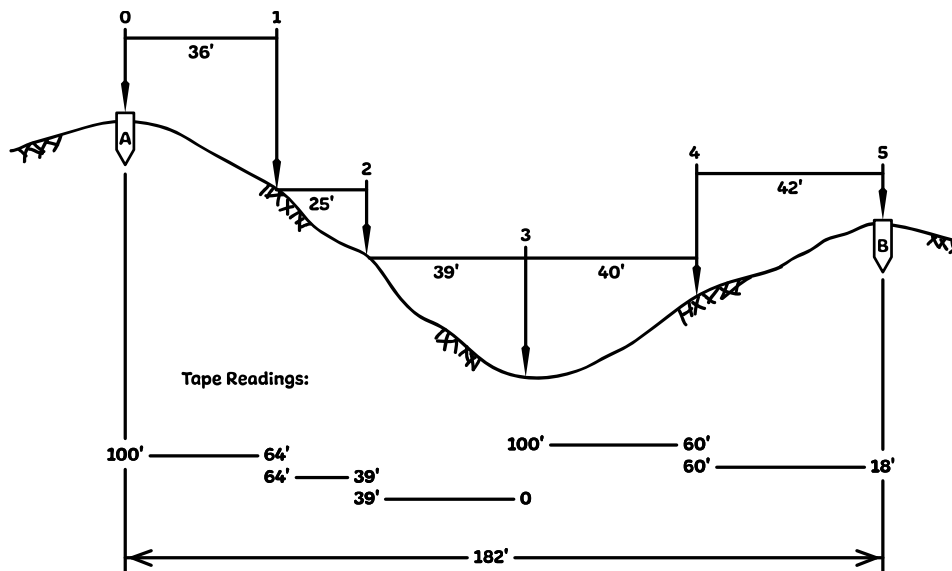

Figure 2-10 Breaking Tape

TAPING ERROR

Error is defined as the difference between the true value and the measured value of a quantity. Errors result from instrument imperfections, personal limitations, and natural conditions affecting the measurement. An error is either systematic or random. A mistake is not considered an error, but is a blunder on the part of the observer such as the failure to record each 100 ft in taping, misreading a tape, forgetting to level the instrument, etc. While the reasons for errors below are specifically for steel tapes, many of them apply to other types of tapes as well:

1. The tape is not the standard length. This results in systematic error which may be eliminated by standardizing the tape or comparing the true length of the tape with some permanent standard of length. The tape may be sent to the Bureau of Standards in Washington D.C. for standardization or may be standardized in a local laboratory equipped for this type of work. Generally, errors due to this reason may be offset by varying the amount of tension applied to the tape
2. Poor alignment of the tape. Both chainmen are required to be constantly aware of the condition of the tape as they move along the line. The instrument operator also helps ensure that the tape is on line over the entire length from point to point. Poor alignment results from sloppy or lazy habits developed by the chainmen. A variable

systematic error is produced which may be reduced almost completely if care is exercised in aligning the tape. This is probably the least important of the chaining errors because in 100 ft the error amounts only to 0.005 ft if one end is off line one foot. This type of error tends to make the measured length greater than the true length, therefore, the error is positive

3. Tape not horizontal. This error produces an effect similar to that due to poor alignment. Once again, this error results from a sloppy procedure and with a little care may be virtually eliminated. Even an experienced chainman probably underestimates the rate of slope. This may be a large source of error and in rough or deceptive terrain, a hand level may eliminate the error
4. Tape twisted or not straight. When taping through fairly dense undergrowth, when the wind is blowing, over a stubble field, or across a harvested cornfield, keeping all parts of the tape in perfect alignment with both ends is difficult. The error in this case is systematic and variable and has the same effect as that which arises from measuring with a tape that is too short
5. Human error of observations. There are accidental errors caused by misreading the tape, improper setting of pins and stakes, and errors due to plumbing improperly due to inexperience or sloppy procedure. All accidental errors may be kept to a minimum by exercising care and following proper procedures
6. Variations in temperature. Materials expand as the temperature rises and contract when the temperature falls. In Indiana the ambient air temperature may vary from 10 or 15° below zero to 100 to 105° F. Daily temperatures may vary from the 40 to 50°F early in the morning to 80 to 90°F by mid-afternoon. These temperature extremes cause the tape to expand and contract. A change in temperature of 15° F will result in a change in length of about 0.01 ft for a 100 ft tape
7. Variations in tension. A steel tape is elastic and stretches when tension is applied. The amount of pull is most important and is required to be known to make the tape the right length. Again, this type of error is systematic and depends on the methods employed and who is doing the taping. Generally, a pull of 10 pounds is sufficient when the tape is fully supported. A pull of 20 pounds or more is necessary when the tape is unsupported throughout its length. This information is obtained when the tape is standardized
8. Tape Sag. Error due to sag in the tape is significant if the tape is relatively heavy and unsupported over the length of the tape. This may be a very important consideration when both rear and head chainmen are plumbing over rough ground. The tapes typically used for highway surveying are heavy, and both the head and rear chainmen are required to be constantly aware of the amount of sag in the tape when plumbing. Controlling a plumb bob, when applying a tension of 30 pounds to a 100 ft tape which is fully unsupported, is very difficult. This procedure takes considerable effort and experience to do a good job

CHAPTER THREE: *MODERN SURVEYING AND MEASURING*

While the modern Highway Technician is rarely called upon to perform surveying tasks, it is helpful to know modern equipment and what it is used for. Understanding what a Contractor's surveyor is doing will help an HT double check that layouts are in accordance with the plans and may help identify concerns before they impact the project.

SURVEYING EQUIPMENT

The total station has taken the place of several traditional tools such as the theodolite and tape measures. Total stations allow a single surveyor to quickly record measurements that would traditionally take 2 people. They utilize various satellite systems like GPS and GLONASS to achieve base location accuracy within just a few centimeters. Once the surveyor has locked in the location of the station distance measurements are accurate to about 1mm for a 300m shot and angle measurements can be as accurate as 0.5 seconds which is 0.000139° . Measurements can then be uploaded into CAD software to create 3D models or used to verify accuracy of the construction progress.

ROBOTIC TOTAL STATION

The most common type of total station seen on INDOT projects is a robotic total station (Figure 3-1). This type is almost always used in conjunction with a rover, and handheld controller. The rover is attached to a rod and has a series of prisms that allow the total station to automatically track it. The surveyor will setup the station on a tripod then takes the prism and controller with them and acquire the required measurements.

SCANNING TOTAL STATION

A scanning total station (Figure 3-2) does exactly what its name implies. It can use its laser to automatically scan an area very quickly without the need for a surveyor to take individual shots with a rover. These are useful for measuring ADA ramps. Under the right conditions a scanning total station can measure all the ramps at an intersection in minutes after it is setup.

SELF-LEVELING LEVEL

As mentioned in Chapter 2, self-leveling levels are still used when a surveyor needs to run a level circuit.



Figure 3-1 Robotic Total Station



Figure 3-2 Scanning Total Station

INCORS

INDOT's Land Survey Section coordinates a network of continuously operating reference stations (CORS). These CORS operate on the Global Navigation Satellite Systems (GNSS) which include GPS, Galileo, and GLONASS. The network is the backbone that allows surveyors in the state to make accurate measurements without running physical measurements to a known fixed point. There are about 45 fixed stations maintained by INDOT, constantly reading satellite data. The data is fed into a central server that allows contractors to download real-time correction data for their equipment on site.

TAPE MEASURES

Finally, we come to the trusty ole tape measure. They may not be glamorous, but they are still widely used on the jobsite by workers and inspectors alike. There are many varieties of tape measures. We covered steel tapes in Chapter 2, but let's take a quick look at three other types you'll likely use in your day-to-day assignments.

POCKET TAPE

A tool you'll already be familiar with is the pocket tape measure. This type isn't used for surveying but is a common tool for length measurements on the jobsite. These are convenient for short distances and can be easily used by a single person.

CLOTH TAPE

The cloth tape is a ribbon of waterproof fabric into which small brass or bronze wires are woven to prevent stretching. This tape may be 50, 100, or even 300 ft long and graduated in feet, tenths, and half-tenths. This type of tape is used principally for earthwork cross-sectioning or in similar work where a light, flexible tape is desired and where small errors in length are not critical. Due to the metallic wires woven into the fabric, a cloth tape conducts electricity and is used carefully near power lines.



Figure 3-3 INCOR Station at the Indianapolis Division of Materials and Tests Building



Figure 3-4 Cloth, Pocket, and Laser Tapes

LASER TAPE

The newest of the three tapes, this uses a laser to measure distances at the push of a button. These are very convenient to take quick accurate measurements and a welcome addition to an inspector's toolbox.

MEASURING WHEEL

The measuring wheel is one of the least accurate tools used on a jobsite for distance measurements. Measured distances are affected by the operator moving the wheel side to side and objects in the path of the wheel among other difficulties. Nonetheless, they are often the quickest and most convenient method an inspector has when measuring long distances.



Figure 3-5 Measuring Wheel

CHAPTER FOUR: *DAILY REPORTING*

Daily Work Reports, or *DWRs*, contain valuable information which details and describes the layout, elevations, and quantities of features and materials incorporated in a construction contract. As such, they are part of the official and legal record of the work done. Notes are required to be kept so that sufficient documentation of original data becomes part of the permanent contract record.

FIELD ASSISTANT

INDOT's own data entry method, Field Assistant, or *FA* for short, allows for entry on any device with a browser and only requires internet connection at the beginning of a shift to download the contract information and at the end of a shift to upload your info. There are some templates that can only be used in Field Assistant and not in the older SiteManager system. Overall, Field Assistant offers a cleaner interface, easier access, and more entry options, and is INDOT's preferred method for data entry.

Field Assistant ensures the data being entered meets system expectations, as this data is used not only by INDOT Construction personnel, but also by many other Divisions whose systems are expecting to see it in a certain way.

In addition to *DWRs*, many different tests can be entered through Field Assistant, and some of them *require* Field Assistant to be used; for instance, HMA 530s *must* be entered via FA.

CREW

In Field Assistant, the first tab as you start a *DWR* is for crew information. You can use the dropdowns to enter your info and even enter more than one crew for a contractor. The required fields are Contractor, Personnel Type, Crew No., and Qty.

EQUIPMENT

The Equipment tab is very similar to the crew tab. Select the correct equipment for each crew and add it to the *DWR*. The required fields are Contractor, Crew No., Equipment, Qty, and Qty Used.

REMARKS

Remarks will cover your description of the day's work operations and other various remark types. After selecting the type of remark you want, type out your information in the box below. The only required remark is *DWR Work Operations*. In the remarks portion of the *DWR* be sure to include enough information that someone reading your *DWR* has a picture of the work accomplished for the day. Consider answering the six basic questions: Who? What? When? Where? Why? How?

Crew Equipment Remarks

(*) Denotes required fields

*Contractor: Select Contractor... *Personnel type: Select Personnel Type...
 *Crew No.: Select Crew... Add Crew *Qty: 1

Add Delete Selected

Show 10 entries Search/Filter:

Contractor	Crew	Personnel Type	Qty	Action
No data available in table				

Showing 0 to 0 of 0 entries Previous Next

Figure 4-3 The Field Assistant "Crew" tab

Crew Equipment Remarks

(*) Denotes required fields

*Contractor: Select Contractor... *Crew No.: Select Crew...
 *Equipment: Select Equipment... *Qty: 0 *Qty Used: 0

Add Delete Selected

Show 10 entries Search/Filter:

Contractor	Crew	Equipment	Qty	Qty Used	Action
No data available in table					

Showing 0 to 0 of 0 entries Previous Next

Figure 4-1 The Field Assistant "Equipment" tab

Crew Equipment Remarks

(*) Denotes required fields

*Select a Remark Type: BCOP : DWR Work Operations

Remark

Add/Update Remarks

Show 10 entries Search:

Remark Type	Text	Action
No data available in table		

Showing 0 to 0 of 0 entries Previous Next

Figure 4-2 The Field Assistant "Remarks" tab

WORK ITEMS

The last tab filled out in a typical daily is the work items tab. You will need to select the appropriate item for payment and input additional information on the following tab including location, station, quantity, and contractor who installed the item. Many items have templates that will calculate the paid quantity based on field measurements. If you have an item that has these select the appropriate shape and input the required information.















Icon	Name	Requirement	Icon	Name	Requirement
	Rectangle	Base, Height		Rectangular Volume	Base, Height, Length
	Circle	Diameter		Sphere	Diameter
	Trapezoid	Base 1, Base 2, Height		Trapezoidal Volume	Base 1, Base 2, Height, Length
	Right Triangle	Base, Height		Right Triangle Volume	Base, Height, Length
	Triangle	Side A, Side B, Side C		Pyramid	2-D Base Shape, Height
	Segment	Chord Rise		Cone	Base Diameter, Height
	Planned Quantity*	Pay Quantity, Plan Pg #		Cylinder	Diameter, Height
*Not a geometric shape				Average End Area	Two 2-D Base Shapes, Length

Figure 4-4 Field Assistant's Template Options

Pay Items							
PLN	CLN	Item Code	Item Desc	Item Unit	Bid Qty	Remaining Qty	Daily Qty
0013	0013	202-02240	PAVEMENT REMOVAL	SYS	73263	-196.96	
0014	0015	202-02637	PIPE ABANDON AND GROUT FILL	LFT	730	488	
0015	0016	202-51368	SLOPEWALL, REMOVE	SYS	390	-65.86	
0016	0017	202-91385	INLET, REMOVE	EACH	11	0	
0017	0018	202-93995	SIGNAL POLE FOUNDATION, REMOVE	EACH	1	0	
0018	0019	202-94954	BARRIER WALL, CONCRETE, REMOVE	LFT	896	-604.80	
0019	0020	202-96133	PIPE, REMOVE	LFT	2171	-72	
0020	0021	203-02000	EXCAVATION, COMMON	CYS	505	505	
0021	0022	203-02000	EXCAVATION, COMMON : , FOUNDATION IMPROVEMENT	CYS	4302	4302	
0024	0026	207-09934	SUBGRADE TREATMENT, TYPE IB	SYS	95628	-29013.65	

Showing 1 to 10 of 145 entries

Previous 1 2 3 4 5 .. 15 Next

Figure 4-5 The Field Assistant "Pay Items" panel

Figure 4-6 The Pay Item Amount screen

SITEMANAGER DWR

SiteManager is INDOT’s legacy record-keeping software and has been in use for decades. While Field Assistant is the most convenient method to enter Dailies and Pay Quantities, the data generally ends up in SiteManager, with some exceptions. SiteManager is a viable place to enter data directly but requires a reliable internet connection which may cause issues in the field. It also has a maximum amount of sign-in time which, if eclipsed, may cause entered data to be lost.

This section covers the tabs that need filled out on a typical DWR in SiteManager.

DWR INFO

Your SiteManager DWR should contain information on the crews you observe each day. Take notes of the work progress, and questions or concerns that arise, and bring any concerns to the attention of the PEMS. On multi-project contracts it may be helpful to keep notes in separate paragraphs for easier tracking. The only required remark is the DWR Work Operations. In the remarks portion of the DWR be sure to include enough information that someone reading your DWR has a picture of the work accomplished. Consider the six basic questions: Who? What? When? Where? Why? How?

Figure 4-7 SM DWR Info

CONTRACTORS

On the Contractors tab you will need to select the contractors you observed for the day and input the supervisors and workers from each trade that were on site.

Figure 4-8 SM Contractor tab

CONTRACTOR EQUIPMENT

On the Contractor Equip tab you will need to select the equipment types on-site and how many of each were used for the day.

Figure 4-9 SM Contractor Equipment tab

WORK ITEMS

The last tab filled out in a typical daily is the work items tab. You will need to select the appropriate item for payment and input additional information on the following tab including location, station, quantity, and contractor who installed the item.

INDOT Instid	Project Number	Project Line Nbr	Contract Line Nbr	Category Number	Category Description	Item Code	Description
<input checked="" type="checkbox"/>	1111114	0012	0037	0001	BRIDGE DECK REPLACEMENT	205-51230	EXCAVATION, FOUNDATION, UNCLASS
<input checked="" type="checkbox"/>	1111111	0040	0198	0001	BRIDGE DECK REPLACEMENT	801-06710	FLASHING ARROW SIGN
<input checked="" type="checkbox"/>	1111112	0060	0265	0001	REPLACE SUPERSTRUCTURE	807-86843	WIRE NO 4 CU 1/C
<input checked="" type="checkbox"/>	1111113	0014	0034	0001	BRIDGE REPLACEMENT	205-12108	STORM WATER MANAGEMENT BUDGET
<input checked="" type="checkbox"/>	1111113	0021	0042	0001	BRIDGE REPLACEMENT	211-09264	STRUCTURE BACKFILL, TYPE 1
<input checked="" type="checkbox"/>	1111113	0121	0170	0001	BRIDGE REPLACEMENT	718-12308	GEOTEXTILE FOR UNDERDRAIN, TYPE 2
<input checked="" type="checkbox"/>	1111114	0011	0035	0001	BRIDGE DECK REPLACEMENT	205-12109	SWGCP PREPARATION AND IMPLEMENT

Figure 4-10 SM Work Items tab

ADDITIONAL RESOURCES

For additional technical information on Field Assistant and SiteManager, please go to the INDOT Construction Information website found below and scroll down to the SiteManager Manuals link under Personnel Development Tools. The SiteManager Manuals link includes manuals not only for SiteManager and Field Assistant, but also for other frequently used INDOT applications like *DMF Entry*, *Contractor Payroll Management System*, and more.

<https://www.in.gov/indot/div/construction.htm>

CHAPTER FIVE: CROSS SECTIONS

Cross sections are necessary for measurement of earthwork volumes in roadway construction. They are profile views of the ground, perpendicular to the centerline or base line, and indicate ground elevations at points of change in the ground slope (Figure 5-1).

Sections are taken at pre-determined intervals, normally 50 ft or 100 ft along the centerline or baseline.

An elevation is taken at the centerline and at intervals right and left of the centerline, normally 25 or 50 ft. Sometimes elevations are taken at points other than normal intervals depending on the terrain, for instance, at locations of change in the slope of the ground, lane lines, etc.

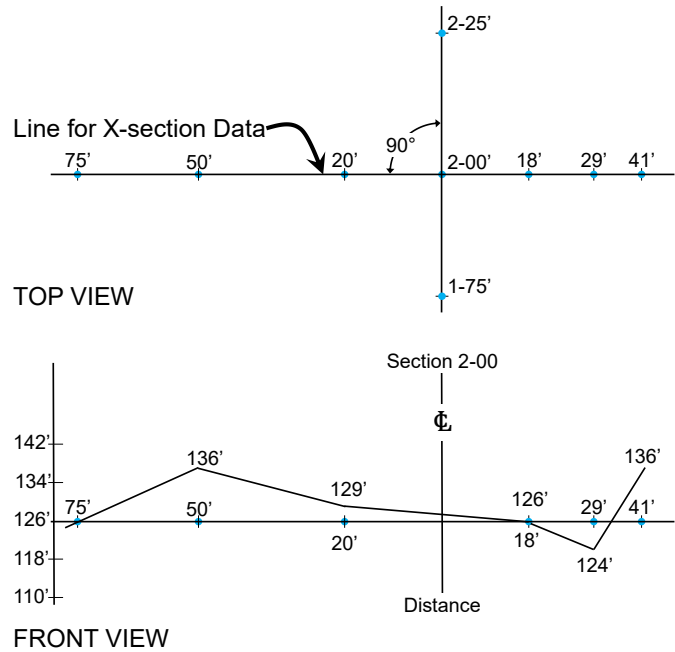

Figure 5-1 Cross Section

SIDE SLOPES

Side slope (Figure 5-2) is defined as the slope of the cut or fill expressed as the ratio of horizontal distance to vertical distance.

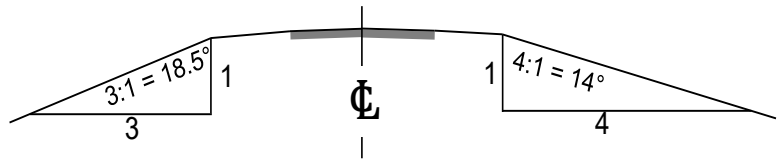

Figure 5-2 Side Slope

EXAMPLE

A 2:1 side slope indicates that for every horizontal distance of 2 ft, the corresponding vertical distance is 1 ft as indicated in Figure 5-3.

$$\text{Side Slope} = \frac{\text{Horizontal Distance}}{\text{Vertical Distance}} = \frac{50'}{25'} = \frac{2}{1} = 2:1$$

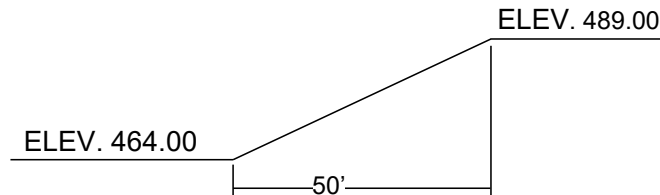

Figure 5-3 Slope Example

ORIGINAL CROSS SECTIONS

Original cross sections indicate the profile of the original ground before the ground is disturbed. These measurements may be used for primary design, estimating volumes, etc. Borrow pit original cross sections are taken after stripping has occurred.

Before beginning a contract, the original cross sections are checked every 500 ft and compared to the cross sections shown on the plans. If these check sections vary consistently by more than 0.2 ft, the original sections may have to be retaken.

PROFILES

Profiles indicate a vertical cross section or side view of the surface of the earth, and are necessary for design and construction of the roads, curbs, sidewalks, drainage systems, etc.

The plotting of profiles is generally a graph of elevations plotted on the vertical axis as a function of horizontal distance (stations or offset distances). The vertical scale is usually exaggerated in comparison to the horizontal scale, which helps make the shape of the ground more easily visible. This is especially helpful when plotting profile grades at intersections, railroad crossings, bridge approaches, wedge levels, etc.

Profiles are plotted on plan and profile sheets in the plans. Figure 5-4 is one example:

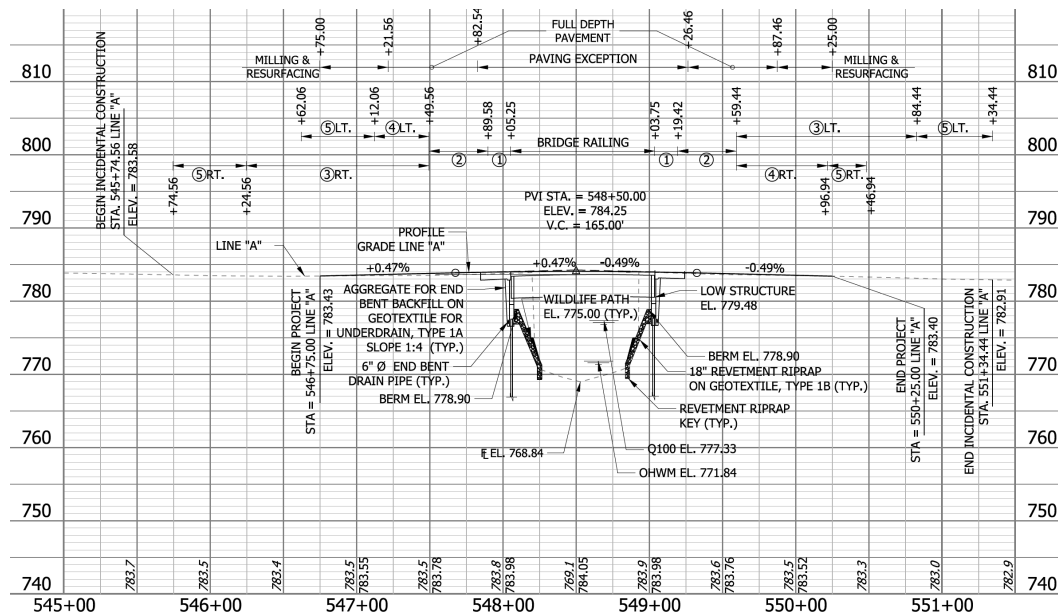

Figure 5-4 Profile

ZERO SECTION

A zero section is a section in which no earthwork was done. These usually occur at the beginning and ending of contracts.

SPLIT SECTION

A split section is sometimes necessary so earth quantities are not overestimated. They consist of two sets of cross sections taken at the same station. You might find a split section at an MSE wall where there is an abrupt change in fill from one side of the wall to the next.

EXAMPLE

Two Sections would be required at station 5+50, one labeled *5+50 back* and one labeled *5+50 ahead*. Not splitting the section into *back* and *ahead* sections would result in an erroneous quantity. Splitting the section ensures that a break is made in the earthwork computations so the assessment is accurate.

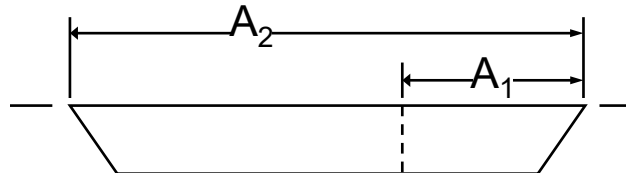

Figure 5-5 Section Break Example

SECTION AT 5+50

A1 = Area to be used for 5+50 back
A2 = Area to be used for 5+50 ahead

MATCH LINES

Match lines occur when two sections from two separate baselines intersect at a point common to both baselines. Match lines are also those lines made when there is not enough cross section paper to accommodate the entire section.

INTERPOLATION

The estimation of an unknown section from two known adjacent sections is called interpolating that section. Usually, an original section requires to be interpolated since the original conditions no longer exist. The number of required interpolated sections varies depending on the number of changes in ground elevation between the two known sections.

To interpolate, assume that the ground is on a straight grade between the known sections. Points that are equidistant from the baseline for the known sections are selected. This distance is figured for the unknown section.

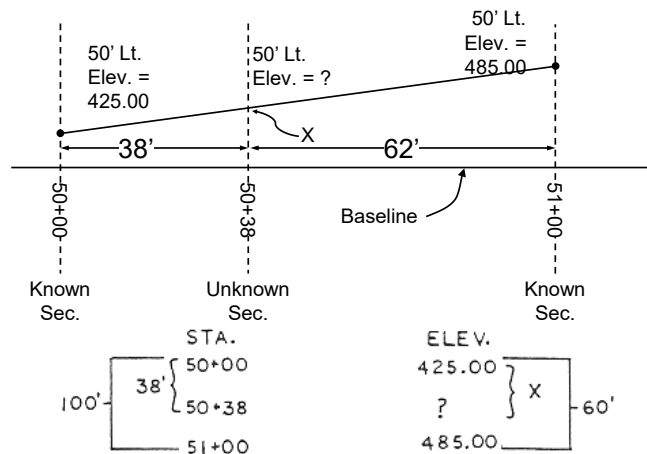

Figure 5-6 Interpolation Example

EXAMPLE

To figure the elevation of a point 50 ft left of a baseline at station 50+38, Figure 5-6 is explained in the procedure outlined below.

1. x is the difference in elevation from station 50+00 to station 50+38
2. 38 is to 100 as x is to 60,

$$38/100 = x/60$$

3. Therefore,

$$x = (38/100) \times 60 = 22.80 \text{ ft}$$

4. Note that the ground elevation from station 50+00 to 51+00 is rising. This means that the elevation at station 50+38 is greater than the elevation at station 50+00, so we add 22.8 ft to 425.00 to obtain the elevation at station 50+38:

$$425.00 + 22.80 = 447.80 \text{ ft}$$

EARTHWORK QUANTITIES

Earthwork quantities are usually measured in cubic yards and may be a cut or fill. The volumes are computed as the product of an area and a distance. Methods for determining volume include:

1. Picking or stripping
2. Plane geometry
3. Planimeter
4. Coordinates

Plane geometry is the method most commonly used by INDOT. It simplifies volume calculation by reducing complex shapes into more basic geometric figures.

Plane Geometry starts by dividing the section into regular shapes such as triangles and trapezoids, with dimensions being determined either by scaling or from field data. Areas are then computed from basic geometric formulas.

Once the areas of the sections are determined, the volume V between two adjacent sections may be computed by using the Average End Area Method shown in Figure 5-7 and described below:

$$V (yd^2) = \frac{A_1 + A_2}{2} \times L \times \frac{1 yd^3}{27 ft^3} \quad \text{or} \quad \frac{(A_1 + A_2)(L)}{(2)(27)}$$

where:

A_1 = End Area 1 in ft^2

A_2 = End Area 2 in ft^2

L = distance between stations in lft

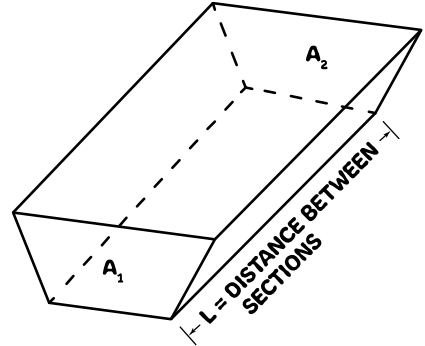
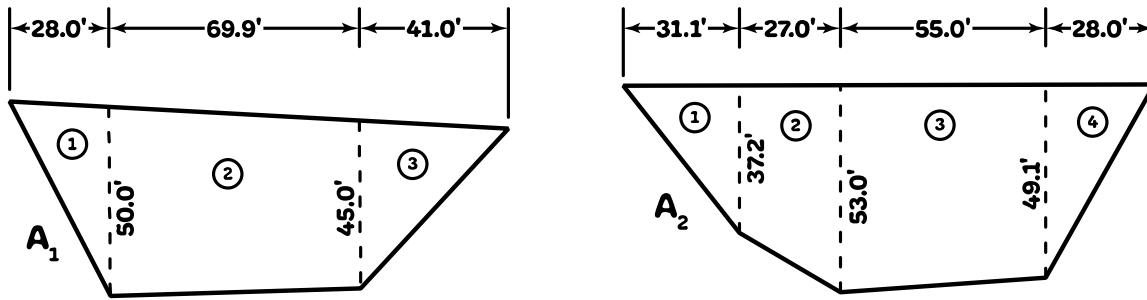

Figure 5-7 Average End Area

EXAMPLE

Given the following end sections A_1 , located at 805+75.00, and A_2 , located at 805+00.00, as shown below, determine the quantity of earthwork.



For End Area A_1 :

Area 1:

$$\frac{1}{2} \times 28.0 \text{ ft} \times 50.0 \text{ ft} = 700.0 \text{ ft}^2$$

Area 2:

$$\frac{50.0 \text{ ft} + 45.0 \text{ ft}}{2} \times 69.9 \text{ ft} = 3320.25 \text{ ft}^2$$

Area 3:

$$\frac{1}{2} \times 41.0 \text{ ft} \times 45.0 \text{ ft} = 922.5 \text{ ft}^2$$

Total Area A_1 :

$$700 \text{ ft}^2 + 3320.25 \text{ ft}^2 + 922.5 \text{ ft}^2 = 4942.75 \text{ ft}^2$$

For End Area A_2 :

Area 1:

$$\frac{1}{2} \times 37.2 \text{ ft} \times 31.1 \text{ ft} = 578.46 \text{ ft}^2$$

Area 2:

$$\frac{37.2 \text{ ft} + 53.0 \text{ ft}}{2} \times 27.0 \text{ ft} = 1217.7 \text{ ft}^2$$

Area 3:

$$\frac{53.0 \text{ ft} + 49.1 \text{ ft}}{2} \times 55.0 \text{ ft} = 2807.75 \text{ ft}^2$$

Area 4:

$$\frac{1}{2} \times 28.0 \text{ ft} \times 49.1 \text{ ft} = 687.4 \text{ ft}^2$$

Total Area A_2 :

$$578.46 \text{ ft}^2 + 1217.7 \text{ ft}^2 + 2807.75 \text{ ft}^2 + 687.4 \text{ ft}^2 = 5291.31 \text{ ft}^2$$

Total Volume V :

$$V = \frac{4942.75 \text{ ft}^2 + 5291.31 \text{ ft}^2}{2} \times 75.0 \text{ ft} \times \frac{1 \text{ yd}^3}{27 \text{ ft}^3} = 14213.97 \text{ yd}^3$$

CHAPTER SIX: *SLOPE STAKES*

Slope staking is a special form of leveling to determine the point at which the proposed slope intersects the existing ground. Since these stakes define the actual construction limits, they are set in the early stages of a contract and as such require preservation for later use.

Information that is required to be known before the setting of slope stakes may proceed is:

1. The profile grade for each station.
2. Typical cross section for each station.
3. Original cross section with elevations.

Scaling the distance from plots of original and proposed cross sections is a graphical method for establishing the slope stake location. While this method is widely used, the procedure may not be advisable for the following reasons:

1. Incomplete or incorrect information at needed stations.
2. Original survey of sections may not be accurate, especially in rough terrain.
3. Changes in the original ground, due to farming, erosion, etc., may have occurred if the time from design to construction is extensive.

The Trial and Error method using the centerline as the reference is the proposed method discussed in this chapter.

DEFINITIONS

CONTROL POINT

The control point for a fill section is the shoulder break. For a cut section the control point is the bottom of a side ditch (Figure 6-1). The elevation of these points and the distances from the centerline are required.

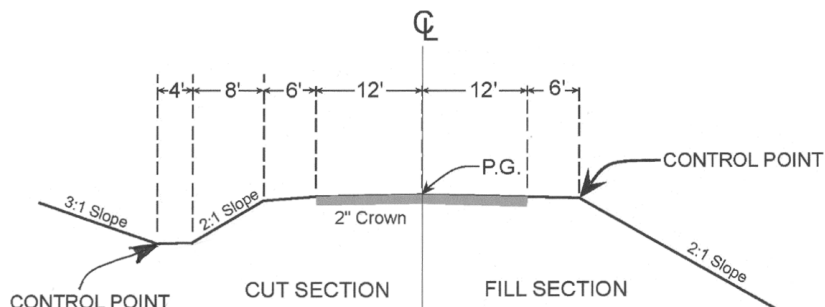

Figure 6-1 Control Points

GRADE ROD

A grade rod is defined as the height of instrument (HI) minus the control point elevation.

GROUND ROD

The ground rod is the actual rod reading during a trial. The grade rod reading minus the ground rod reading designates whether the section is a cut or fill section.

READING SLOPE STAKES

Historically, slope stakes have been necessary to determine if the roadway is being built to the required lines and grades. The slope stake is the tool that is used to ensure that slopes are graded correctly and fill or cuts are made to the required elevations. The following example explains how to read a typical slope stake.

EXAMPLE

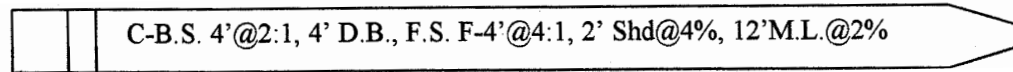

Starting at the slope stake, the following steps are taken:

1. Cut the back slope 4 ft deep at a 2:1 slope.
2. Grade a 4 ft ditch bottom.
3. Go up the foreslope 4 ft at a 4:1 slope.
4. Go 2 ft at a 4 % slope for the shoulder.
5. Go 12 ft at a 2 % slope to the centerline.

The outcome of these steps is presented in the cross section shown in Figure 6-2.

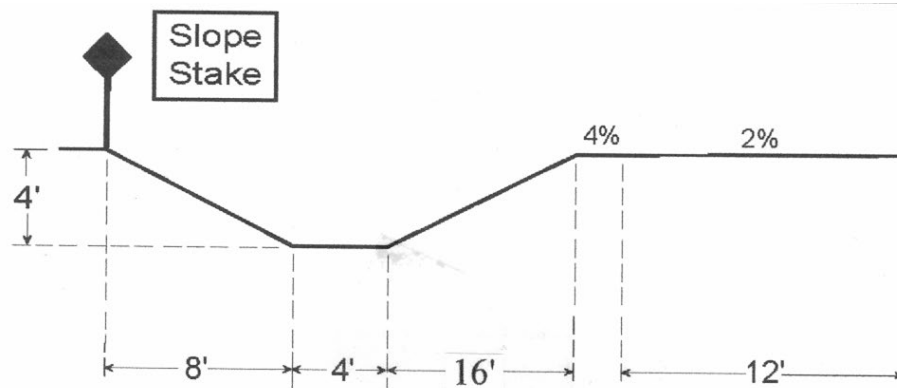

Figure 6-2 Example Slope Stake Grading Cross Section

CHAPTER SEVEN: RADIUS POINTS

LAYING OUT RADIUS POINTS FOR DRIVES/APPROACHES

The layout of a radius point may be done by a single person with a steel, fiberglass, or cloth tape. Since a cloth tape is subject to stretching or shrinking, depending upon the age and/or weather conditions, a steel or fiberglass tape is preferred.

LAYOUTS FOR SQUARE DRIVES/APPROACHES

The procedure for determining a layout for a square drive or approach (Figure 7-1) is:

1. Determine the point, or station, where the drive or approach and the width of the drive or approach intersect
2. Measure one half of the drive width along the edge of pavement from the intersection and mark this point A
3. Measure the radius distance from point A along the edge of pavement and mark this point B
4. Measure the radius distance from point B perpendicularly and mark this point C, the *radius point*

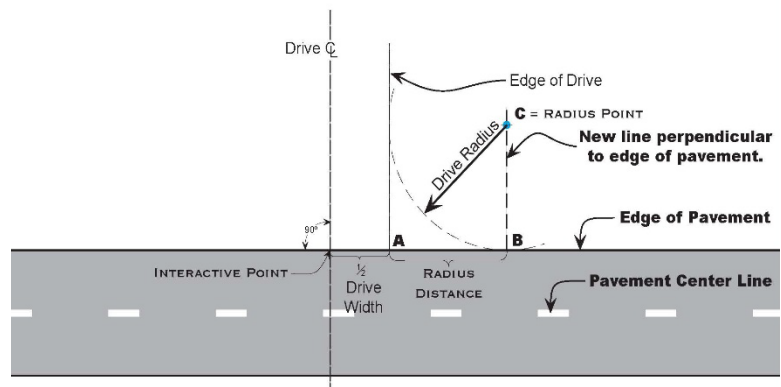

Figure 7-1 Radius Layout for Square Drive/Approach

To verify, a chaining pin is used to mark point C. When the radius is swung from this point, it should intersect the edge of pavement and the edge of the drive, in which case a hub with a nail should be set to mark the radius point C. If the radius does not fit, point C may be adjusted by moving the chaining pin and rechecking until the above criteria are met prior to driving the hub. After the hub is set, the *drive radius* can be determined by hooking the end of the tape over the nail (Figure 7-1).

LAYOUTS FOR SKEW DRIVES/APPROACHES

Driveways and approaches on skew angles are determined as indicated in .

Examples of drives and approaches can be found in these Standard Drawings:

- E 610-DRIV
- E 610-PRAP

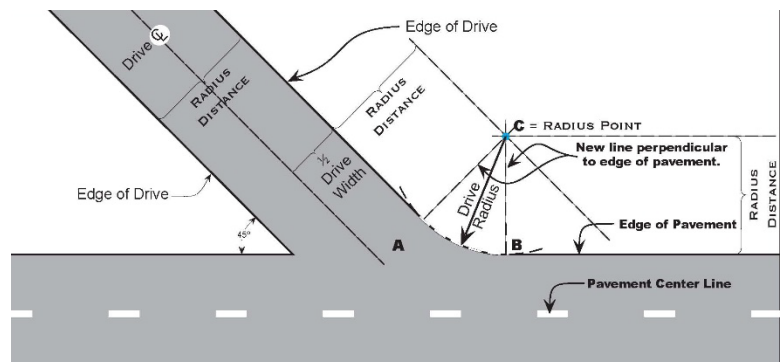

Figure 7-2 Drive/Approach on Skew Angle

EXAMPLE

A new road is being constructed in an East-West direction. A Class II Drive intersects the new pavement on the north side at Station 49+75 at a 90 degree angle. The radius is 15 ft on the west side and 25 ft on the east side. The drive width is 14 ft, the lane width is 12 ft and there is no paved shoulder. Stationing increases from west to east. Find the station and offset of the radius points.

Solution:

1. Locate the Drive \mathbb{C} , Station 49+75, on the north edge of pavement
2. Measure one half the drive width, $\frac{14\text{ ft}}{2} = 7\text{ ft}$, in each direction from Station 49+75:
 - a. [STA. 49+75] - 7 ft = [STA. 49+68] (to west of drive)
 - b. [STA. 49+75] + 7 ft = [STA. 49+82] (to east of drive)Mark these points A_{west} and A_{east} to use for sight lines.
3. Add the radius distances to the 7 ft previously measured:
 - a. $15\text{ ft} + 7\text{ ft} = 22\text{ ft}$ from drive \mathbb{C} on west side
 - b. $25\text{ ft} + 7\text{ ft} = 32\text{ ft}$ from drive \mathbb{C} on east sideMark these points B_{west} and B_{east} on the edge of the mainline pavement
4. Use the distances from the previous step to determine the stations of the radius points:
 - a. [STA. 49+75] - 22 ft = [STA. 49+53] (to west of drive)
 - b. [STA. 49+75] + 32 ft = [STA. 50+07] (to east of drive)
5. Calculate the offset for radius points using the radius and lane width:
 - a. $12\text{ ft} + 15\text{ ft} = 27\text{ ft}$ LT offset for C_{west}
 - b. $12\text{ ft} + 25\text{ ft} = 37\text{ ft}$ LT offset for C_{east}
6. Mark radius points C_{west} and C_{east} using the determined stationing and offset
7. Swing in the radius for each side and check that it just intersects the *Edge of Drive* line, 7 ft from the Drive \mathbb{C} , on the right and left of the driveway

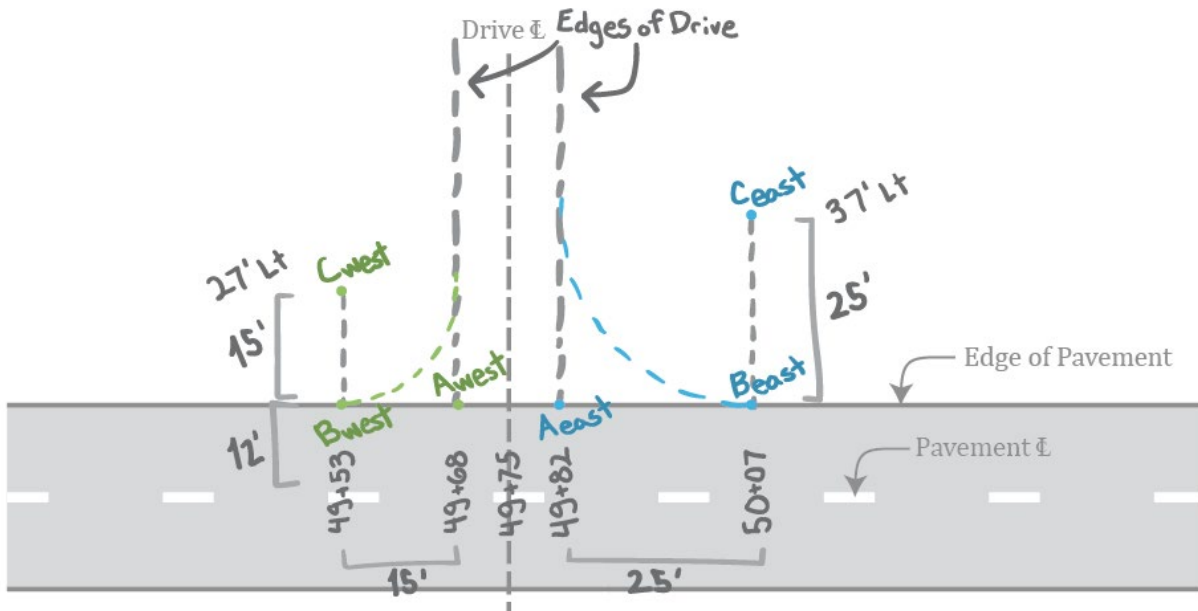

Figure 7-3 Solution to the Example

APPLICATION OF DRIVES AND APPROACHES

TURN LANES

Turn lanes are used in conjunction with Public Road Approaches *Type C* and *Type D* as indicated on Standard Drawings **E 610-PRAP**. The lengths of the tapers and turn lanes depend on the designed speed of the mainline pavement, the angle of intersection, and the intersecting approaches traffic count. The Standard Drawings include Tables for determining the required distances given the design speed, vertical roadway grade, and angle of intersection. Distances are measured from the station of the approach intersection, then required offsets are measured and marked so the radius points can be set.

DRIVEWAYS

Driveways are indicated on Standard Drawings **E 610-DRIV**. There are several types of drives, as follows:

CLASS I:	Private Drive, 6" concrete, 10 to 20 ft wide
CLASS II:	Private Drive, 4" HMA, 12 to 24 ft wide
CLASS III:	Commercial Drive, 9" concrete, 20 to 40 ft wide
CLASS IV:	Commercial Drive, 10" HMA or 9" concrete, 20 to 40 ft wide
CLASS V:	Field Entrance (dirt), 24 to 40 ft width (minimum 32 ft desirable)
CLASS VI:	Heavy Industrial & truck stops, 10" HMA or 9" concrete, 32 to 50 ft wide
CLASS VII:	Heavy Industrial & truck stops (w/ curb/gutter), 10" HMA or 9" concrete, 32 to 50 ft wide

Using the class, station number and width of the drives as given in the approach table in the plans, radius points may be set and the drives marked out as previously discussed.

MAILBOX APPROACHES

Standard Drawings **E 610-MBAP** list approaches for driveways and mailboxes. There are three types of approaches indicated in these Standard Drawings:

1. Typical Mailbox (no nearby associated drive)
2. Combination Mailbox & Drive, Mailbox Located in Advance of Drive
3. Combination Mailbox & Drive, Mailbox Located Beyond Drive

The width of the approach varies according to the traffic volume, or *ADT*, of the road. Low traffic volume width is used only when the design speed is less than or equal to 45 mph.

Approaches are a minimum 8' wide when $ADT < 1500$ and 10' wide when $ADT > 1500$.

Most HMA resurface contracts have approach widths of 8 ft maximum. On some older roads, mailbox approaches may be only 2 ft wide.

Required dimensions are given on the Standard Drawings. For new construction, approaches may be marked out using the stations given in the plans' approach table with dimensions from the Standard Drawings. Adjustments may be made for approaches to match existing driveways. On resurface contracts, stationing for driveways and mailboxes are not given and must be marked out to match what exists in the field.

CHAPTER EIGHT: *PIPE STRUCTURES*

Proper placement and backfilling of pipe structures is critical for maintaining the base support for the pavement placed over the pipe, and for providing correct loading of the pipe for structural integrity. This chapter discusses installation methods for pipe and sewer work.

PIPE TYPES

Pipe is specified by types, according to the pipe use, as set out in the miscellaneous Standard Sheets and Standard Specifications. Type 1 is placed under mainline or public road approaches, Type 2 is used for storm sewers, Type 3 is placed under all drives and field entrances, and Type 4 is used for drainage tile and longitudinal underdrains. Under each pipe type, the pipe materials that are required are indicated. These sheets also indicate the pipe material abbreviations which are used throughout construction in the plans and proposals (Figure 8-1). When pipe is listed by type, the Contractor may use any pipe material that meets the requirements of that type. If the item states a pipe material such as Reinforced Concrete Pipe, that is the material that is required to be used.

When using the Standard Drawings, checked for the effective date of the standards required for the contract. The effective date on a standard drawing is required to be the most recent September 1st prior to the contract letting date. In other words, if a contract is let on May 05, 2022, the effective date would be September 1, 2021.

Besides listing pipe materials, the Standard Drawings list notes for cover limits and other installation information. The pipe type table is shown in Standard Drawing **E 715-PIPE-01**. Construction details shall be in accordance with Standard Specifications Section **715**.

PIPE END TREATMENTS

There are several different types of pipe end treatments being used. The Technician is required to know which type is required for each structure because some end treatments affect the length of pipe necessary for construction. The standard drawings indicate details for each type of end treatment. The end treatments used are as follows:

1. Metal pipe end sections
2. Safety metal end sections
3. Concrete pipe anchors
4. Grated box end sections
5. Inlets or catch basins
6. Manholes

Of the units indicated above only concrete pipe anchors do not affect the overall length of a pipe structure significantly.

GRATED BOX END SECTION

If a grated box end section (GBES) was being used on the same type of slopes, there would be 6 ft less pipe on each end of the pipe structure.

STRUCTURE DATA TABLE

The structure data table is a summary table at the end of the plan set that shows many important details for all the pipe structures on the project. Some of the details found in the table are:

1. Station
2. Diameter
3. Pipe Type
4. Structure Type
5. Pipe Length
6. Backfill Method
7. Backfill Quantity
8. Type of End Treatment

Construction details shall be in accordance with Standard Specifications Section **715.03**. The inspector must review all of the pipe and structure locations prior to installation to verify there are no errors in the table. Any possible problems should be reported to the PEMS.

In new construction, most structure lengths may be paid the listed lengths in the structure data table after verifying in the field. Take special note, of locations for Tees or Elbows.

BASIS OF USE FOR PIPE MATERIALS

Different types of pipe materials have different testing markings.

METAL PIPE

Metal pipe items are marked with metal tags having a 6-digit number stamped onto the tag. This tag verifies that the pipe has been inspected.

CONCRETE PIPE

Concrete pipe items are required to be produced by a Certified Precast Concrete Producer on the Approved list. The pipe is required to have the date of manufacture and the source number on the pipe. Also, pipe manufactured by a Producer who is also certified by the American Concrete Pipe Association is required to have the "QCast" symbol or have the words "ACPA Certified Material" on the pipe. Pipe made by a manufacturer certified by the National Precast Concrete Association is required to have the words "NPCA Certified Material" on the pipe.

PLASTIC PIPE

Plastic pipe items are accepted by a Certification stating that the pipe meets the required Specification ratings. This certification is usually a Type A or Type C as indicated in the Frequency Manual.

METAL PIPE END

Metal pipe end sections have tag numbers as described for metal pipe.

SAFETY METAL END SECTION

Safety metal end sections have tag numbers as described for metal pipe.

OTHER ITEMS

Precast inlets, catch basins, manholes and GBES are required to be produced by Producers that are on the Approved list for Certified Precast Concrete Producers the same as concrete pipe.

RECORDING TAGS FOR BASIS OF USE

When a shipment of metal pipe arrives on the job-site, all tag numbers on the invoice are recorded as the pipe is checked. The count of these numbers and units is required to agree with what the Supplier is indicating. The PEMS also receives a report (TD-392) from the pipe plant Technician indicating all the pipes produced and the corresponding tag numbers.

MULTI-PLATE PIPE

On structural plate steel pipe or multi-plate pipe, a yellow card is attached to the invoice indicating the inspection numbers. A pipe report is issued by the pipe Technician, similar to the report for the other pipe items.

MISCELLANEOUS CONCRETE

For any concrete items poured in place, such as pipe anchors, inlets, or pipe collars, the basis of use is the **IT 652** report in Field Assistant.

RECORDING TAGS FOR FUTURE USE

When placing pipe items, the pipe tag numbers are recorded in the Technician's daily reports. These numbers are used by the PEMS to obtain lab numbers necessary for the completion of the material record.

CHAPTER NINE: PIPE PLACEMENT

EXCAVATION

Unless otherwise directed the trench cross sectional dimensions are required to be as indicated on the plans. The trench bottom gives full support to the pipe. Recesses are cut to receive any

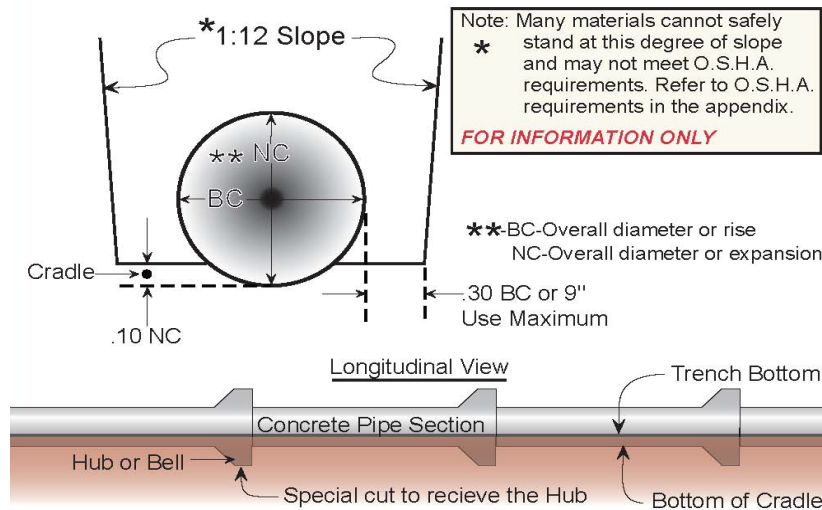

projecting hubs or bells on concrete pipe.

Figure 9-1 indicates some basic trench requirements. These are also indicated on Standard Drawings E 715-BKFL. Construction details shall be in accordance with Section 715.04.

Pipes trenches in fill areas are excavated only after the fill elevation is to a height equal to the top of the pipe plus the minimum cover on the pipe.

Figure 9-1 Pipe Excavation

Recommended cover where heavy construction equipment crosses the pipe structure is:

1. Up to and including 18" diameter or equal – 1' 6" cover
2. Greater than 18" diameter up to and including 54" diameter or equal – 3 ft cover
3. Greater than 54" diameter or equal – 4 ft cover

When the fill height is sufficient to provide the cover listed, the structure may be placed.

ROCK EXCAVATION

When rock is encountered during trench excavation at the flowline elevation, the trench bottom is required to be excavated at least 8" below the required elevation, backfilled with B borrow to the proper grade, and compacted to INDOT Standard Specification requirements.

UNSUITABLE MATERIAL

Any time soft or unstable material is found at the required flowline elevation, such material is required to be removed and replaced. B borrow may be used as the replacement material.

EXCESS EXCAVATION PAYMENT

Cut volumes and B borrow for replacing soft areas are required to be recorded. If the quantity of excavation exceeds 10 yd³, the quantity is paid as three times the excavation class required.

REMOVAL OF EXISTING STRUCTURES

Normally, removal of an existing structure is included in the cost of a new structure item unless a special item is included for the removal. This procedure consists of removing the existing pipe, head walls, box culvert, and footings to outside the limits of excavation for the new structure.

SAFETY

A special concern for safety is required for deep pipe trenches. The Contractor is required to have the necessary safety equipment available such as safety boxes in deep pipe or sewer cuts and/or sheeting or shoring as directed by safety requirements.

LAYING PIPE

STRUCTURE BEARING

Each section of pipe is required to have full bearing for the entire length of pipe and be placed true to the line and grade. Any pipe that does not meet these requirements is required to be re-laid at no additional cost. No pipe is allowed to be placed on a frozen trench bottom.

LAYING CONCRETE OR CLAY BELL PIPE

When laying concrete or clay pipe, the hub or bell end is required to be placed up-grade with the spigot end fully inserted into the next hub and with all ends fitted together tightly.

Pipe joints designed to accommodate seals or pipe joints requiring seals are sealed with approved rubber type gaskets, caulking, asphalt mastic pipe joint sealer, electrometric material, or sealing compound.

If infiltration of water is a factor, each joint, regardless of the type used, is required to be sealed with an approved compression type joint sealer in accordance with the Specifications.

ABS PIPE

If ABS pipe (plastic) is used, all joints are required to be of the solvent cement type and installed according to the recommendations of the manufacturer.

METAL PIPE

Prior to placing corrugated metal pipe, the sections are required to be checked for the proper fit. If sections do not fit together properly, they may be rejected since they could easily leak. This may be a problem on spiral pipe because some Suppliers cut sections to lengths and the end cuts are not square cut. Pipe sections are joined with approved coupling bands. When placing riveted corrugated metal pipe, the section laps are required to be placed downstream.

MULTI-PLATE PIPE

When placing and assembling Structural Plate Steel or Multi-Plate Structures, the Contractor is required to follow the lap of the plate sections as indicated on the shop drawings. The shop drawings are furnished by the Supplier for the proper fit and loading of the pipe structure. Special nuts and bolts may be used for assembly. These nuts and bolts may have crowned faces so they fit down into the corrugations. The proper bolts are always used.

JOINING PIPE WITH COLLARS

When a satisfactory joint cannot be made, different types of pipe are connected, or an existing structure is extended, a concrete collar is required to be placed. At the connection of two different types of pipe, the collars are required to be at least 18" wide and 6" thick.

When joining pipes of different strengths, the pipe of lesser strength than the main pipe is required to be incased in concrete at least 6" thick.

STUB-TEE CONNECTIONS

At locations indicated on the plans or where directed, a stub-tee connection of the size required is furnished and connected to the pipe type specified.

METAL PIPE

The stub-tee for corrugated metal pipe structures is required to be long enough to band to connecting pipes. The band may be a band-type tee or saddle type tee. The stub-tee is bolted or banded to the larger pipe.

CONCRETE PIPE

On concrete pipe, the tee connection may be factory made or field fitted. The stub for the tee is required to be at least 6" long and no more than 12" in length and be secured in place by a mortar bead or a concrete collar.

PIPE END TREATMENTS

The pipe end treatments that may be used include:

1. Pipe anchors
2. Pipe end sections
3. Safety metal end sections
4. Grated box end sections

PIPE ANCHORS

Standard Drawings **E 715-MPCA-01** and **02**, **E 715-PAHB-01**, and **E 715-PASD-01** indicate different sizes and measurements for pipe anchors, which are mainly used on larger pipe. They prevent water flow from undermining the pipe ends, causing settlement or wash outs.

Pipe anchors are poured in place using class A concrete and are held to the pipe by either anchor bolts or straps.

PIPE END SECTIONS

Standard Drawings **E 715-MPES-01** thru **03** and **E 715-PCES-01** indicate different pipe end sections that are available in either metal or precast concrete. Metal pipe end sections connect to the pipe by a strap band or a ring type bolt that draws the end section tight to the pipe. These units have a toewall that is placed in a cut trench and backfilled. This toewall serves the same purpose as an anchor which is to keep water from undermining the pipe.

Precast concrete end sections are designed for use on concrete pipe. The inside of the end section is grooved to accept the spigot end of the pipe. After the precast pipe end section is placed, an anchor of class A concrete is poured. Nuts and washers secure the hook bolts extending through the anchor end section floor.

GRATED BOX END SECTIONS AND SAFETY METAL END SECTIONS

Grated box end sections and safety metal end sections are used to provide a safety slope over the structure opening. Safety metal end sections are detailed on Standard Drawings **E 715-SMES**, and grated box end sections on Standard Drawings **E 715-GBTO** and **E 715-GBTT**. There are two basic types of grated box end sections: Type I and Type II.

GBES TYPE I

Type I grated end sections (Figure 9-2) are used on cross-pipes under the roadway or other structures perpendicular to the direction of traffic. These units are constructed to the same slope as the embankment they fit into and have a tubular type grating which supports vehicles traveling across them.

GBES TYPE II

Type II grated box end sections (Figure 9-3) are used where the end of a structure is facing incoming traffic. They are built to flatter slopes and have a crossbar grating for vehicle support.

Both Type I and Type II units may be either precast or constructed in place. In either case, the units are set on a bed of No. 8 aggregate and the structure is partially backfilled with No. 8 aggregate. This procedure allows ground water to filter in through weep pipes in the sides of the units. Precast units have a toe wall that is poured with class A concrete after the unit is set. Constructed in place units are poured with class A concrete and reinforcing steel as designated in the Standard Sheets.

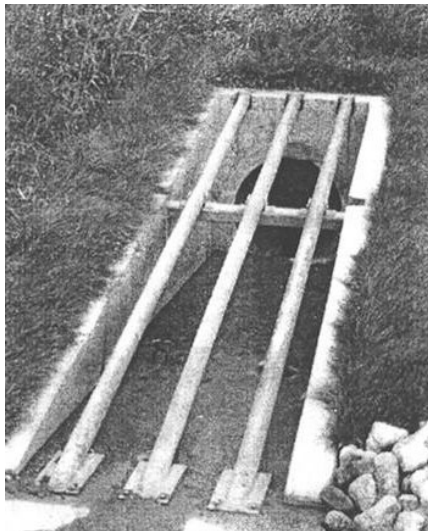

Figure 9-2 GBES Type I



Figure 9-3 GBES Type II

CHAPTER TEN: *MEASUREMENT OF PIPE ITEMS*

PIPE MEASUREMENT

Pipes are paid for by the linear measurement as specified in Section **715.13** and measured from outside of manhole to outside of manhole. For pipes connecting to inlets and catch basins, the pipes are also measured to the outside face of the structure.

TEES, STUB-TEES, AND WYES

Tee, Stub-Tee, and Wye connections are measured along the centerline of the barrel. For making the connection, an additional 5 ft of the smaller pipe size is paid.

ELBOWS

Elbow connections are measured along the centerline of the elbow. An additional payment of 2 ft is allowed for each elbow connection.

OTHER CONNECTIONS

Other connections, such as size reducers, are measured for length and paid as the larger diameter pipe size specified.

ANCHORS

Pipe anchors are paid as each for the size. The reinforcing steel and/or straps are to be included in other costs.

PIPE END SECTIONS AND SAFETY METAL END SECTIONS

Pipe end sections, metal or precast concrete, and safety metal end sections are paid for each according to the diameter of the pipe the sections connect to. This is because 15" metal end sections are required to fit a 12" concrete pipe.

GRATED BOX END SECTIONS

Grated box end sections are paid for each, by the size, slope, and type specified.

COMPUTING STRUCTURE LENGTH USING ELBOWS

Sometimes structures use elbows or bends to decrease the depth of cut in large fills. The following example (Figure 10-1) displays the proper method for computing pipe lengths when bends or elbows are used.

[See an example on the following page.]

EXAMPLE

E-7 Inlet inside measure = $2.5 \text{ ft}/2 = 1.25 \text{ ft}$ on ϕ to end of pipe

If elbows = 4 ft measured along ϕ :

Section (1) = $36 \text{ ft} + 4 \text{ ft} + 12 \text{ ft} + 12 \text{ ft} + 11 \text{ ft}$
= 75 ft

Section (2) = 54 ft

Section (3) = $18 \text{ ft} + 8 \text{ ft}$
= 26 ft

Add Sections = $75 \text{ ft} + 54 \text{ ft} + 24 \text{ ft}$
= 155 ft

Elbow Length = $2 \text{ elbows @ } 4 \text{ ft each} + 2 \text{ connections @ } 2 \text{ ft each}$
= 12 ft

Total Length = $155 \text{ ft} + 12 \text{ ft}$
= 167 ft

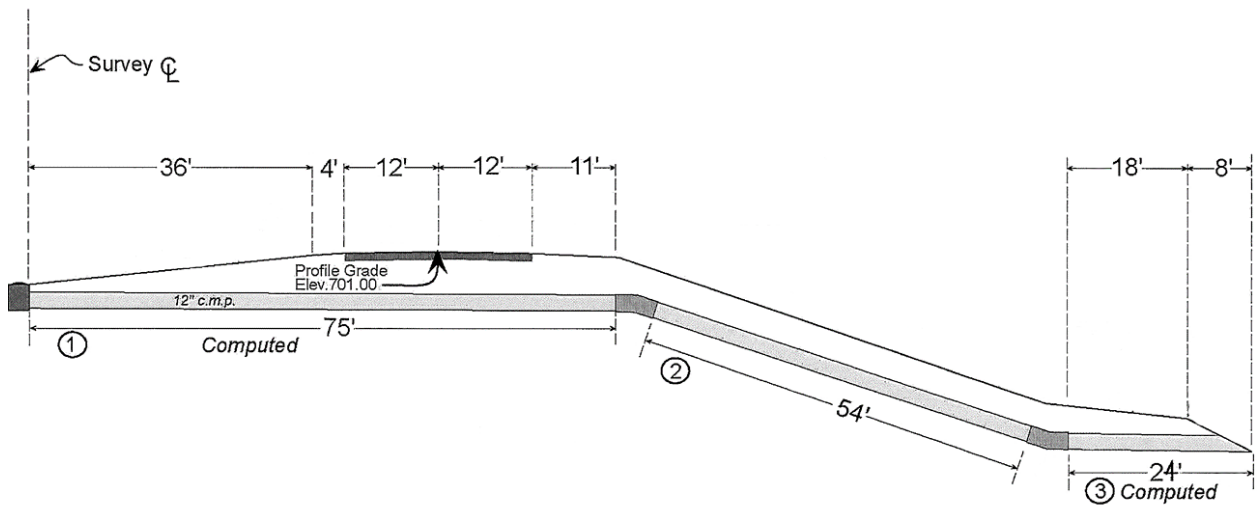

Figure 10-1 Structure with Elbows or Bends

CHAPTER ELEVEN: *MANHOLES, INLETS, AND CATCH BASINS*

There are numerous types of manholes, inlets and catch basins. Diagrams for each type of structure are shown in Standard Drawings **E 720-CBCA**, **E 720-INST**, **E 720-INCA**, **E 720-MHCA**, and **E 720-MHST1**. Construction details shall be in accordance with Section **720**.

STRUCTURE

The letter prefix listed in the Standard Drawings represents the structure type and the number suffix is for the casting type. Thus, an E-7 inlet would be type E box using a type 7 casting.

METHODS OF CONSTRUCTION

Several types of construction methods are designated for manholes, inlets, or catch basins. Some units may be constructed from brick, block, concrete class A, or precast, when allowed. The materials that are used for each type of structure are noted on the applicable Standard Drawing.

When constructing manholes, inlets, or catch basins in the field, the excavation for the floor slab is required be on firm, stable soil. If rock is encountered, the rock is required to be removed 6" below the bottom elevation and backfilled with approved material.

When precast units are used, bases are required to be set on a minimum of 4" of compacted B borrow.

MATERIAL REQUIREMENTS

CONCRETE

Concrete construction is required to be in accordance with Section **702** and reinforcing steel in accordance with Section **910.01**.

BRICK OR BLOCK

Brick or other masonry units are required to be laid with joints not exceeding $\frac{3}{8}$ ". If brick is used, at least every 7th course is required to be laid as a header course (Figure 11-1).

In the header course, the bricks are turned so that the mortar joint does not run continuously from the top to the bottom of the structure.

Brick or block structures are required to have a $\frac{1}{2}$ " mortar plaster coat on the inside and outside of the structure, as designated.

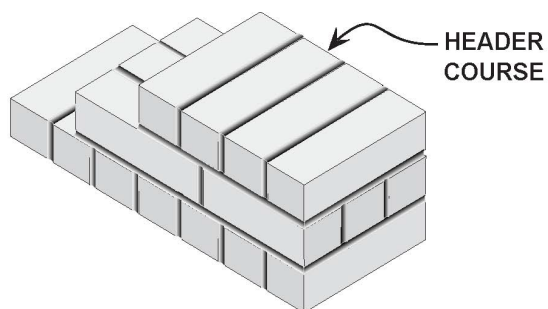

Figure 11-1 Brick Manhole, Inlet or Catch Basin

STRUCTURES IN PAVEMENT AREA

When manhole castings are surrounded by concrete pavement, the casting is required to be the same thickness as the concrete pavement. Where castings are adjacent to or surrounded by concrete pavement, they are separated from the concrete pavement by using a $\frac{3}{8}$ " minimum thickness preformed joint filler.

HOODS FOR CATCH BASINS

Cast iron hoods for catch basins are to be installed in the walls of the structure as shown on the plans or in the Standards. These are to be placed so that a 6" seal is formed. Joints between castings and the structure are required to be made gas tight by use of cement mortar.

MORTAR MIXTURE

Mortar for laying brick or block is required to be 1 part masonry cement and 2 parts mortar sand. The mortar for plastering a brick or block structure may be the same or may be made using 1 part Portland cement, 1 part hydrated lime and 2 parts mortar sand. The lime should not exceed 10% of the cement.

PRECAST STRUCTURE OPENINGS

When using precast structure components, the opening for the pipe may be either preformed or field cut. The gap between the structure and the pipe is required to be filled with Class A concrete. If openings are cast or cut in the wrong locations, they are required to be filled satisfactorily and the new holes placed in the required locations. The cost to cut or form holes and seal the pipe with a concrete collar is included in the structure cost.

STRUCTURE JOINTS

Horizontal joints may be used in the construction of precast structures. The Contractor or Supplier is required to submit drawings showing the location of the joints, type of joints, and types of sealers to be used for approval prior to the construction of these units. No joint may be closer than 3" above standing water for those catch basins requiring hoods.

ADJUSTMENTS

There is no cost adjustment for precast structures that are required to be located in a different location or that require height adjustment to meet the necessary grade. These costs are included in the structure costs.

GRADE ADJUSTMENT TO EXISTING STRUCTURES

ADJUSTING EXISTING STRUCTURES

When grade adjustments for existing structures is required, the casting frame, covers, or gratings are required to be removed and the walls of the structure reconstructed as required to meet the necessary elevation. If an existing casting is unfit for re-use, the casting is replaced

with the type specified. If an existing casting is in good condition and is of the type required, the elevation may be adjusted by the use of risers or adjusting rings.

REPLACING CASTINGS

Castings are replaced with the type specified and adjusted to the required grade. This grade adjustment includes up to 12" of masonry reconstruction in average height, cleaning of the existing structure, and keeping the structure clean until the final acceptance of the work.

RECONSTRUCTED STRUCTURES

If masonry reconstruction exceeds 12", that portion above 12" is required to be paid as a reconstructed structure of the type of inlet, manhole, or catch basin specified.

CASTINGS IN PAVEMENT AREA

When castings adjusted to grade are in concrete pavement or adjacent to concrete pavement, they are separated from the concrete by at least $\frac{3}{8}$ " preformed joint filler. The cost of the joint filler is to be included in the cost of other items.

ADJUSTMENT ON RESURFACE CONTRACTS

On resurface contracts, unless otherwise allowed, castings are required to be adjusted prior to placing the surface course.

MANHOLE, INLETS, AND CATCH BASINS

BASIS OF PAYMENT

Payment, by each, is made for the placed quantity and type specified of manholes, inlets, or catch basins. Castings are paid as each, for the type specified. Castings furnished and adjusted to grade (not exceeding 12" or masonry work) are paid as each for the type specified. The portion of masonry work necessary above a 12" average height is paid for by the linear foot and the type of structure specified.

MISCELLANEOUS REQUIREMENTS

Excavation, backfill, reinforcing steel, replacing pavement, and other miscellaneous items necessary to complete the work are not paid for directly, but are included in the cost of the other items.

CHAPTER TWELVE: *PIPE AND STRUCTURE*

BACKFILL

BACKFILL LIMITS

The trench for a pipe must be backfilled as indicated on the plans or Standard Sheets with structural backfill or coarse aggregate (Section **211.02**) or flowable backfill (Section **213.02**). Flowable backfill must use an approved mix design with a successful trial batch demonstration.

BASIS OF USE

The basis of use for structure backfill or coarse aggregate is a Certified Aggregate Producer Program (CAPP) D Number. The Contractor has the option of using a local site and having a CAPP Certified Aggregate Technician or a consultant on the Department's list of approved Geotechnical Consultants for gradation control. The Frequency Manual is reviewed to verify the testing requirements. The basis of use for flowable mortar is the flow test in accordance with **ASTM D 6103**, the lightweight dynamic cone penetrometer test in accordance with **ITM 216**, and the dry unit weight test in accordance with **ITM 218**.

To conduct the flow test, a 3" diameter by a 6" cylinder is placed on a smooth level surface and filled to the top with the flowable mortar. The cylinder is quickly pulled straight up and the mortar spread measured. The diameter of the mortar spread is required to be at least 8".

The lightweight dynamic cone penetrometer (DCP) test requires determination of the blow count penetration resistance of flowable backfill, after a 3 day cure, to assess the strength of the material. Removable flowable backfill shall have a penetration resistance blow count of not less than 12 nor greater than 30. Non-removable flowable backfill mixes shall have an average penetration resistance blow count greater than 30.

The dry unit weight test is used to calculate the removability modulus (RM) of the flowable backfill. If the RM is calculated at 1.0 or less, the flowable backfill is classified as removable.

BACKFILL METHODS

There are different methods of required backfill depending on the pipe structure location and purpose, as indicated on Standard Drawings **E 715-BKFL**.

TRENCH DETAILS

Standard Drawings **E 715-BKFL** give general trench details.

ROCK

If rock is encountered during excavation for the pipe, the rock is required to be removed 8" below the bottom of the pipe. B borrow is used as backfill to bring the pipe to the proper flowline.

BEDDING DETAILS

All of the details use structure backfill or flowable backfill bedding for pipe, where pipe is bedded in a soil cradle cut. The Standard Drawings indicate the proper limits and dimensions for backfilling with its material.

BACKFILL PLACEMENT

All plastic pipes that are not fabricated with hydrostatic design basis resins, except underdrains, are to be backfilled with flowable mortar when the pipes are within 5 ft of the mainline or public road approaches.

Placement of structure backfill material is required to be placed in no greater than 8" loose lifts and compacted with mechanical compactors to the required density. When compacting structure backfill, the material may be compacted to the required density with a moisture content which is normally several points below optimum density. Section **211.03** of the Standard Specifications discusses structure backfill types 1, 2, and 3.

Flowable mortar must be uniformly placed up to the fill line as indicated on the plans or Standards. All standing water must be removed before flowable mortar is placed in a trench. If this is not possible, it is filled with structure backfill to 2 ft above ground water level.

METHOD 1 BACKFILL

When a pipe is placed under mainline pavement or under public road approaches, or it is within 5 ft or less of pavement, sidewalk, curbs or gutters, Method 1 Backfill is used. Method 1 requires that flowable mortar or structure backfill be used as backfill for the width of the pavement + 5 ft on each side of the pavement. Method 1 is used for a distance required to maintain a 2:1 slope from the determined width to the bottom of the pipe structure. Method 1 Backfill for a fill section is indicated on Standard Drawings **E 715-BKFL-02** and for a cut section is indicated in Standard Drawings **E 715-BKFL-01**. Proper elevation of backfill material is maintained as indicated in the Standard Drawings. The remaining area may be backfilled with suitable materials in layers of not more than 6" when inside the slope stake area.

METHOD 2 BACKFILL

When a pipe is placed under commercial or private drive approaches, Method 2 Backfill is used. Method 2 requires that B borrow or flowable mortar be placed at a height of over one-half the outside diameter of the pipe structure. The length of the backfill material is the same as Method 1 Backfill. Method 2 Backfill for a cut and a fill section is indicated on Standard Sheets **715-BKFL-06** and **715-BKFL-07**. The remaining area may be backfilled with suitable materials in layers of not more than 6" when inside the slope stake area.

OTHER BACKFILL

Where other than special backfill material is required, the material is required to be easily compacted and free of large stones for the portions around and 6" above the pipe.

OUTSIDE BACKFILL SPECIFIED LIMITS

If the structure is outside the aforementioned areas, the pipe may be backfilled with suitable material.

COVER LIMITS

The proper cover is required to be maintained for heavy equipment to cross pipe structures during construction. The cover requirements are:

- 1. Up to and including 18" diameter or equal1' 6" cover
- 2. Greater than 18" up to and including 54" diameter or equal3' 0" cover
- 3. Greater than 54" diameter or equal4' 0" cover

RAMPS OVER STRUCTURE FOR PROTECTION

If the minimum amount of cover is not available, the Contractor is required to ramp over with soil to provide the coverage needed to prevent structure damage.

LIMITATIONS

Flowable mortar will not be placed on frozen ground and must be protected from freezing for 72 hours. Flowable mortar may not be loaded or disturbed until obtaining an average penetration resistance of 70 psi under PCCP pavement or 1200 psi under HMA pavement.

PAYMENT FOR BACKFILL

STRUCTURE BACKFILL

When the proposal contains an item for structure backfill, the material is paid for by the cubic yard based on a theoretical measurement. The Construction Record Guide has charts indicating different cover heights and the amount of structure backfill per linear foot required for different pipe diameters and material types. This guide is for pipe backfill limits only. The cost of backfilling manholes, inlets and catch basins is included in the item cost.

FLOWABLE BACKFILL

When the contract contains an item for flowable backfill, this material is paid for by the cubic yard based on a neat line theoretical measurement. If flowable backfill is used as a substitute for structure backfill or if used to backfill plastic pipe fabricated with nonhydrostatic design basis resins, flowable backfill is paid for as structure backfill.

EXAMPLE

A Contractor placed a 30" diameter corrugated metal pipe measuring 152 lft outside to outside of the inlets. The Technician measured the cover in several locations and found it to be an average of 5.8 ft. Calculate the theoretical pay quantity for structural backfill:

Using the table for backfill, we get a factor of 1.2203 yd³/lft. Therefore,

$$152 \text{ lft} \times 1.2203 \text{ yd}^3/\text{lft} = 185.5 \text{ yd}^3$$

CHAPTER THIRTEEN: *RELINING EXISTING PIPE STRUCTURES*

A new method of reconditioning existing structures, by which an existing structure is relined with a thermoplastic liner, is currently being used. Using this method saves costly disruption to traffic, especially in areas where a structure has a high fill over the pipe.

SLIP LINING ROADWAY CULVERTS WITH POLYETHYLENE CULVERT PIPE

High density polyethylene pipe liner is used for relining existing in-place concrete, vitrified clay, or metal culvert pipe. The annular space between the liner and the existing culvert is filled with cellular grout. The Contractor is required to furnish and install the liner and grout in accordance with Section **105.03** and **725**.

MATERIALS

The materials used to manufacture the liner are required to be high density high molecular weight polyethylene pipe material meeting the requirements of Type III, Class C, Category 5, Grade P34 as defined in **ASTM D 1248**. Clean rework material, generated by the manufacturer's own production, may be used if the liner produced meets all the requirements of the Specifications.

The liner material is required to be homogeneous and free from visible cracks, holes, foreign inclusions, or other injurious defects. The liner is required to be uniform as commercially practical in color, capacity, density and other physical properties. Standard laying lengths are required to be a minimum of 19 ft, but not exceed 40 ft or as specified by the PEMS.

The liner is required to have a maximum n-factor of .012 and be capable of maintaining a minimum flow rate equivalent to 100 percent of the original in-place culvert. The liner is also required to have a Standard Dimension Ratio (SDR) equal to 32.5, have a minimum pipe stiffness of 46 psi when tested per **ASTM D 2412**, or be Class 160 type pipe in accordance with **ASTM F 894**. SDR is defined as the ratio of the liner outside diameter to the minimum thickness of the wall of the liner. and may be expressed mathematically as:

$$SDR = \frac{D}{T}$$

where:

D = liner outside diameter in inches

T = minimum liner wall thickness in inches

Jointing the liner is by either bell and spigot, screw type, thermal welding, or a grooved press-on joint approved by the PEMS. The joint is required to have sufficient mechanical strength to allow the liner to be installed through the existing pipe without affecting the joint's integrity. Jointing is required to provide water tight integrity for all joints and not interrupt the flow characteristics of the pipe.

A 12" section of the liner is required to show no evidence of splitting, cracking, or breaking when compressed between parallel plates to 40 percent of its outside diameter within 2 to 5 minutes. The liner is required to have sufficient rigidity to withstand being placed by either pulling or pushing and exhibit a minimum amount of distortion.

The manufacturer is required to furnish certifications to the Office of Materials Management stating that the materials used in the manufacture of the liner meet the requirements of **ASTM D 1248** for the type, class, category, and grade specified. The manufacturer is required also to certify that the finished liner is in compliance with this Specification.

The materials used to manufacture the cellular grout are governed by the following:

- Fine Aggregate**904.02**
- Fly Ash.....**901.02**
- Foam Concentrate**ASTM C 796**
- Water**913.01**

Admixtures, retarders, and plasticizers used are required to be in accordance with the foam concentrate Supplier's specifications. Portland cement is required to be in accordance with Section **901.01 (b)**, except Type II cement is not allowed.

The grout is made using the preformed foam process using generating equipment calibrated by the manufacturer to produce a precise and predictable volume of foam. The foam concentrate is certified by the manufacturer to have specific liquid/foam expansion ratio at a constant dilution ratio with water.

The specific job mix is submitted by the foam concentrate certified Contractor to the PEMS for approval prior to use on the contract. The mix is required to have a minimum 28-day compressive strength of 150 psi or be approved based on prior acceptance and suitable performance on INDOT contracts.

Grout mixed off site is delivered to the job site in a half-filled truck mixer, per **702.09**. The foam concentrate is then added to the cement mix in the truck and mixed to a uniform consistency. Grout mixed on site is batched in a deck mate or a similar device. Small batches of approximately 1 yd³ are mixed and pumped in a continuous operation.

For each day worked or for each 100 yd³ placed, four test cylinders measuring 3" by 6" are cast. The cylinders are obtained from the point of placement and are prepared, cured, and transported per **ASTM C 31** and **ASTM C 192**. The cylinders are tested per **ASTM C 39**, except the test specimens are broken within the permissible tolerance prescribed as follows:

Test Age	Permissible Tolerance
24 hours	½ h
3 days	1 h
7 days	3 h
28 days	22 h

EQUIPMENT

All equipment necessary for the satisfactory performance of this work is required to be approved by the PEMS. The equipment includes all machinery necessary for the installation of the liner, grout, and the reworking of the temporary easements.

The equipment used to produce the grout and all equipment used in the mixing, pumping and placing is certified as to suitability by the Supplier of the foam concentrate.

The Contractor supplying and placing the grout is certified by the foam concentrate Supplier and is required to be capable of developing a mix design, batching, handling, pumping and placing grout under the contract conditions.

RIGHT OF ENTRIES

All right of entries necessary for the work are required to be acquired by the Contractor. All damage within these areas is repaired to the original condition and bare areas having sod cover are required to be repaired. The Contractor is required to install and maintain temporary fence as directed by the PEMS.

CONSTRUCTION REQUIREMENTS

The Contractor is required to re-establish the flow line of any eroded inverts, with grout meeting the requirements as set out in the Specifications. Pre-mixed grout may be used subject to approval of the PEMS. The Contractor is required to maintain a positive flowline in the liner. Any obvious cavities under the existing pipe are filled with grout.

After the liner has been completely inserted and has been inspected by the PEMS, the liner is cut off flush with the ends of the existing culvert or as directed by the PEMS and grouted in place. If the liner had been exposed to the sun before insertion is made, the liner is allowed to cool to the temperature of the existing culvert before being cut off and grouted.

Block and mortar bulkheads are placed at both ends of the culvert. A 2" vent hole at the crown and a 1" hole at the invert are placed in the downstream bulkhead. An access hole, sized to facilitate the method of grout input, and a 2" air vent are placed at the crown in the upstream bulkhead.

The grout is placed from the upstream end of the culvert where practical. The vent holes in the downstream bulkhead are plugged as soon as grout begins to flow out each hole. The 2" air vent in the upstream bulkhead is kept clear until grout begins to flow out of the vent.

The grout is placed by either gravity flow or by low pressure pumping to completely fill all voids within the annular space without causing deformation of the liner. The grout extends for the full length of the culvert.

Grout placed by gravity flow is limited to a maximum length of flow of 10 ft for each foot of available head per access hole. Additional access holes, where required, are drilled from the top and sleeved with 6" PVC piping.

Liner storage areas are required to be approved by the PEMS. All drainage structures and ditches are required to remain open at all times, and traffic control is required to be in accordance with the MUTCD or as directed.

All liner sizes are required to be approved by the PEMS prior to installation.

All incidental work, such as brush removal, flowline adjustments, etc., is done by the Contractor. Where required, and practical, a bull nose device is pulled through the existing culvert to facilitate the liner installation. The bull nose device is of appropriate diameter to permit the installation of the intended liner size. The pipe is completely cleared of all foreign material just prior to the installation of the liner.

JACKED PIPE

Jacking steel or reinforced concrete pipe consists of pushing the pipe through or under an embankment. See Standard Specifications Section **716** for additional information.

CONSTRUCTION REQUIREMENTS

An approach trench is dug at the forward end of the proposed pipe to a depth sufficient to form a vertical face at least 1 ft higher than the top of the pipe and large enough to provide ample working room. The size and height of this vertical face may vary; however, the roadbed and shoulders are required to always be adequately protected. After the pipe is installed, the excavated area not occupied by the pipe is backfilled with suitable material and thoroughly compacted into place.

Sheeting and bracing is provided if the nature and conditions of the soil or height of exposed face is such as to endanger either the traveling public or the integrity of the road surface.

When the use of explosives is necessary for the prosecution of the work, their use is required to be in accordance with Section **107.13**.

When ground water is known or anticipated, a dewatering system of sufficient capacity to handle the flow is maintained at the site until the dewatering system operation may be safely halted. The dewatering system is required to be equipped with screens or filter media sufficient to prevent the displacement of fines.

Jacked pipe is constructed so as to prevent leakage of any substance throughout the length of the pipe. Installation by open-trench methods is permitted only at locations indicated and is required to be in accordance with the applicable specifications for that type of installation.

JACKING

Excavation is undertaken within a steel cutting edge or shield attached to the front section of pipe to form and to cut the required opening for the pipe. Excavation is not carried ahead of the pipe far enough to cause a loss of soil. When jacking in loose, granular, or running soils, the shield is required to have a means for inserting steel baffle plates and shelves for the purpose of preventing voids.

The thrust wall is required to be adequate for installation of the jacked pipe and be constructed normal to the proposed line of thrust.

A suitable lubricant, such as bentonite, may be applied to the outside surface of the jacked pipe to reduce frictional forces. This material is applied by the use of pressure equipment which

pumps the lubricant to the outside of the shield on the lead pipe. The lubricant may be pumped outside the surfaces of the pipe through the grout holes.

The jacking equipment conveys its thrust load to the pipe through a sufficiently rigid thrust ring to ensure distribution of the load without creating point loading.

Bracing, backdrops and jacks are required to be sufficient so that jacking may progress without stoppage, except for adding lengths of pipe, until the pipe reaches the leading edge of the pavement as shown on the plans.

When necessary to prevent loss of soil at the heading, the face of the excavation is required to have an adequate bulkhead when the work is shut down at the end of the working day.

BORING

Boring consists of pushing a pipe into the fill with a boring auger rotating within the pipe to remove the spoil. Advancement of the cutting head ahead of the pipe is not allowed, except for that distance to permit the cutting head teeth to cut clearance for the pipe. If granular, loose, or unstable soil is encountered during the boring operation, the cutting head is retracted into the casing a distance that assures no voiding is taking place. The excavation by the cutting head is required to not exceed the outside diameter of the pipe by more than ½". The face of the cutting head is arranged to provide reasonable obstruction to the free flow of soft or porous material.

The use of water or liquids to soften or wash the face of the cutting head is not permitted. Water may be used in sticky clays to facilitate spoil removal provided the water is introduced behind the cutting head. Lubricating agents, such as bentonite, may be used to lubricate the casing and reduce friction between the casing and embankment.

If an obstruction is encountered during installation which stops the forward progress of the pipe, operations are required to cease. The pipe is abandoned in place and filled completely with grout or other approved materials. The abandoned work is paid for in the amount of at least 75% of the contract unit price as specified in the schedule of pay items.

Bored or jacked installations have a bored hole essentially the same as the outside diameter of the pipe. If voids should develop or if the bored hole diameter is greater than the outside diameter of the pipe by more than approximately 1", grouting or other approved methods are required to be used to fill such voids with no additional payment.

JACKING CONCRETE PIPE

Only reinforced concrete pipe of 30" inside diameter and larger may be jacked. The pipe is required to be class IV or stronger with tongue and groove joints. All pipes are required to have steel reinforcement concentric with the pipe wall, and, where required, additional reinforcement at the ends of the pipe. The pipe is required to be in accordance with **ASTM C 76**.

To avoid concentrated loads at the joints from pipe to pipe, strips of plywood, asphalt roofing paper, or other similar resilient materials are inserted around the circumference in the joints as each pipe is placed ahead of the thrust ring. Resilient material is also used between the pipe end and the thrust ring.

JACKING STEEL PIPE

For jacking steel pipe, the joints are welded in accordance with Section **711.32** and required to be water tight. The minimum wall thickness of the pipe is as follows:

Outside Diameter (in)	Wall Thickness (in)	
	Casing Contains Carrier	Casing Used as Carrier
≤ 18	¼	¼
19-20	¼	5/16
21-26	¼	3/8
27-30	3/8	½
31-42	3/8	½
43-48	½	9/16

CHAPTER FOURTEEN: *MULTI-PLATE PIPE*

PLATES

The plates for Multi-Plate pipe are furnished in two lengths, nominally 10 ft and 12 ft long. In special instances, one or more 6 ft long plates may be furnished. Plate widths and hole counts are shown in the following table:

Plate Width (ft)	# holes across each end
3	4
4	6
5	7
6	8
7	9

Each plate is identified by numbers stamped into the inside crest of an end corrugation near the middle of the plate, except plates for special ends have these numbers stamped near each corner before cutting. The first three numbers are the sub item number. The second three numbers are the plate radius in inches. The seventh number is the plate gage number, with the exception that 0 is for 10 gage plate, 2 is for 12 gage plate, and a blank designates a thickness greater than 1 gage. The eighth number is the order item number. The last four numbers are the mill order number. See Figure 14-1 for more detail.

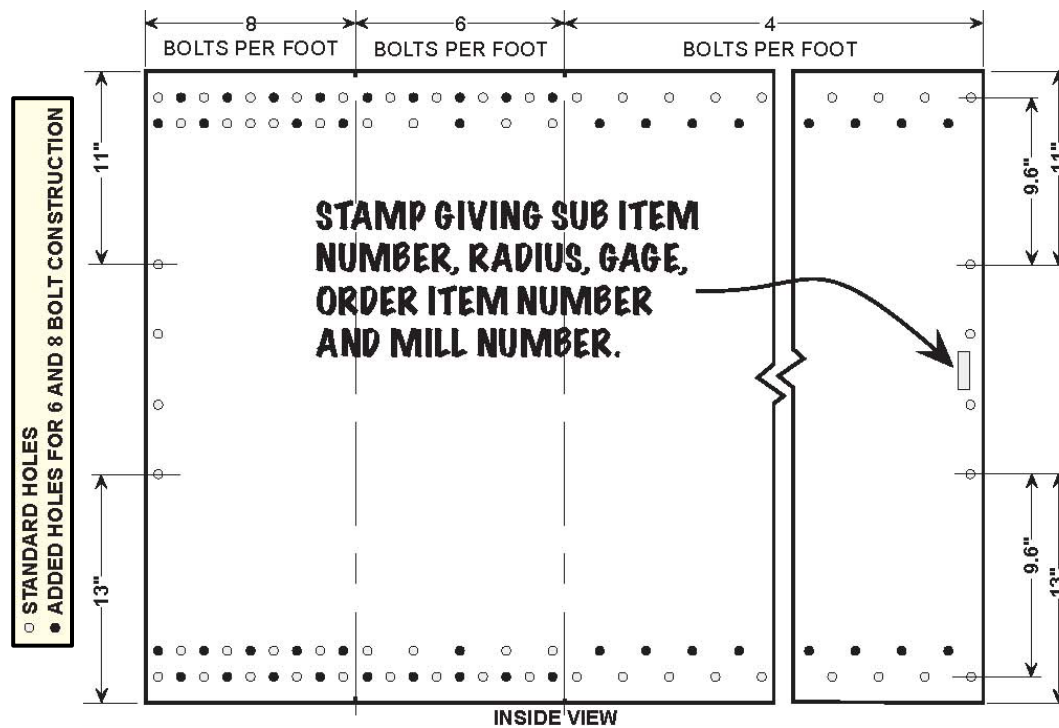

Figure 14-1 Pipe Plate

If the structure is to be erected with skewed or sloped ends, the embossed identification marks are on the inside of each cut plate. Plates to be used in an elbow section are identified with similar embossed numbers on the inside of each cut and welded plate. These numbers correspond to plates marked on the cut end or elbow layout drawing.

BOLTS

For convenience, Multi-Plate bolt and nut containers are stenciled as follows:

$\frac{3}{4}$ " x 1- $\frac{1}{4}$ "

$\frac{3}{4}$ " x 1- $\frac{1}{2}$ "

$\frac{3}{4}$ " x 1- $\frac{3}{4}$ "

$\frac{3}{4}$ " x 2"

$\frac{3}{4}$ " x 3"

NUTS

Each structure has six 3"-long service bolts that are used as assembly tools to temporarily draw the plates together where needed. These bolts should not remain in the structure. The required number of bolts for a structure rarely amounts to full keg lots. The carton containing partial amounts of one size also has the required 3" bolts. This carton is marked accordingly.

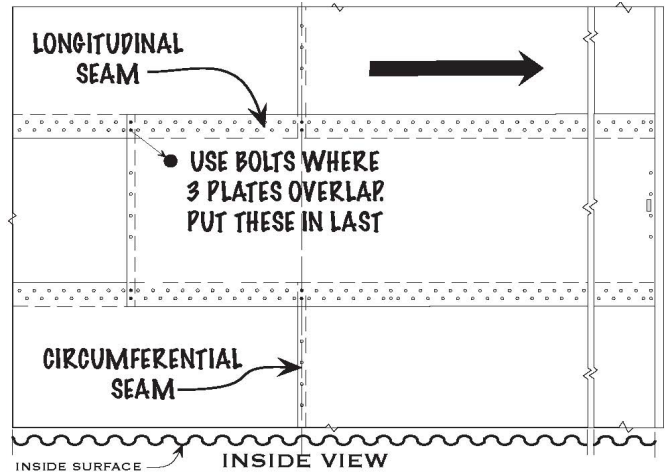

Figure 14-2 Bolt Placement

Bolts are furnished in two lengths. The longer length is used for three thicknesses of metal. The length of bolts furnished for the various plate thickness requirements is as follows:

GALVANIZED PLATES

<u>Plate Gage</u>	<u>Thickness</u>	<u>Bolt Lengths</u>
1 Gage	0.280"	1- $\frac{1}{2}$ " and 2"
3 Gage	0.249"	1- $\frac{1}{2}$ " and 2"
5 Gage	0.218"	1- $\frac{1}{2}$ " and 1- $\frac{3}{4}$ "
7 Gage	0.188"	1- $\frac{1}{2}$ " and 1- $\frac{3}{4}$ "
8 Gage	0.168"	1- $\frac{1}{4}$ " and 1- $\frac{1}{2}$ "
10 Gage	0.138"	1- $\frac{1}{4}$ " and 1- $\frac{1}{2}$ "
12 Gage	0.109"	1- $\frac{1}{4}$ " and 1- $\frac{1}{2}$ "

ASPHALT COATED PLATES

<u>Plate Gage</u>	<u>Thickness</u>	<u>Bolt Lengths</u>
1 Gage	0.280"	1- $\frac{3}{4}$ " and 2"
3 Gage	0.249"	1- $\frac{3}{4}$ " and 2"
5 Gage	0.218"	1- $\frac{3}{4}$ " and 2"
7 Gage	0.188"	1- $\frac{3}{4}$ " and 2"
8 Gage	0.168"	1- $\frac{1}{2}$ " and 1- $\frac{3}{4}$ "
10 Gage	0.138"	1- $\frac{1}{2}$ " and 1- $\frac{3}{4}$ "
12 Gage	0.109"	1- $\frac{1}{2}$ " and 1- $\frac{3}{4}$ "

The longer bolt length is placed in the corners of the plates where three thicknesses of metal overlap, and in the hole next to the corner in the longitudinal seam. The shorter bolt is placed where only two thicknesses of metal overlap (Figure 14-2).

PLATE IDENTIFICATION AND LOCATION

The various widths of plates are located in the barrel in accordance with the plate layout drawings. The numbers appearing in the barrel area or on the plates are the number of bolt holes across the end of each plate. The line layout and/or plate layout shows total 10-ft and 12-ft-long rings making up the structure.

The beginning and ending rings are indicated in Figure 14-3 for square end structures and these structures contain combinations of 10-ft and 12-ft rings required to obtain the proper plate stagger. Special plates in cut end structures are shown on the plate layout together with the necessary 10-ft and 12-ft long plates required to obtain the proper seam stagger in the barrel. Intermediate barrel rings contain plates which are all the same length. For cut plates and elbow cut and welded plates, the numbers appear on the plate layout corresponding to the embossed numbers on the plates themselves.

PIPE-ARCH ASSEMBLY

The pipe-arch is assembled in three stages as follows:

1. bottom
2. corners
3. top

The bottom (invert) plates are assembled by laying the first bottom plate at the outlet end, then placing each succeeding plate in the longitudinal row so the plate laps one corrugation of the preceding plate (Figure 14-3). The invert plates are positioned accurately with a stringline before tightening the bolts.

The two corner bolt holes (Figure 14-4) are different. One bolt is close to the plate edge and the other bolt is set in from the plate edge. When beginning construction, the corner bolt hole pattern is required to match the pattern shown on the plate layout drawing.

After several invert plates have been laid down, aligned, and bolts tightened, the corner plates are attached to each side at the outlet end. The corner plate may lap either inside or outside the invert plates (Figure 14-5). Also, each additional corner plate is required to lap over the preceding plate by one corrugation.

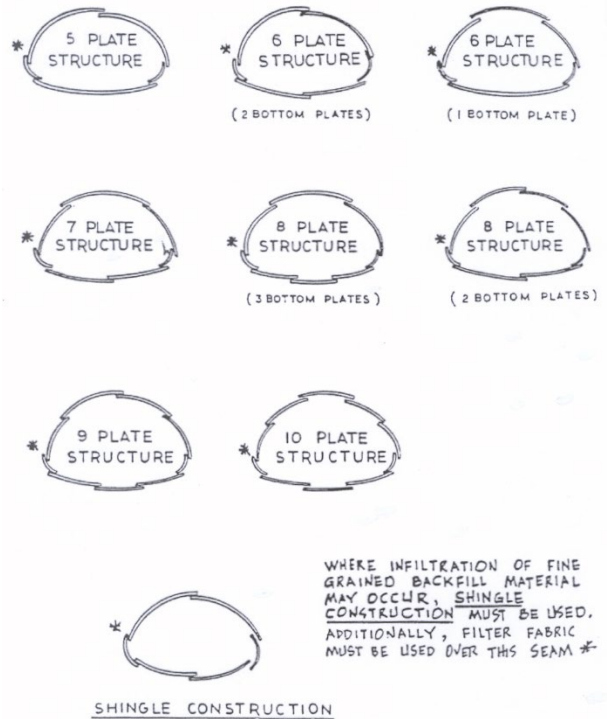

Figure 14-3 Typical Barrel End Views (looking downstream)

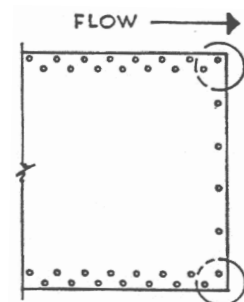

Figure 14-4 Inside View of Pipe

Finally, the top plates are put in place. The upper half of the pipe-arch is assembled with each plate lapping outside the plate immediately below, except at the top corner plate (Figure 14-5). Each row is extended only far enough to support the next row of plates above to a place where one final plate may be added to complete the ring. Each additional top plate laps over the previous plate by one corrugation.

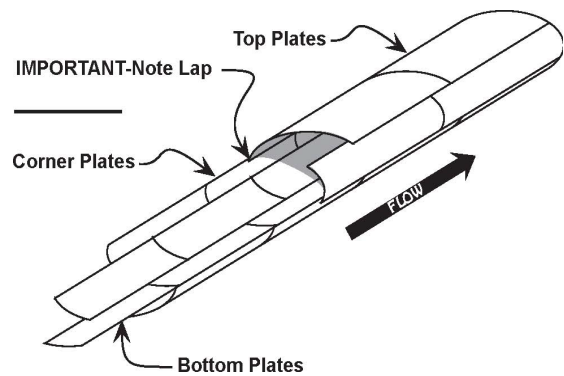

Figure 14-5 Plate Assembly

BOLTING

To facilitate alignment, the initial assembly is done with a minimum number of bolts. Sufficient bolts are inserted in each seam to hold the plates in position; however, the nuts are not tightened, thus leaving the plate free to move slightly to help in matching the remaining bolt holes. Bolting the circumferential seam is best done by first placing the bolts near the middle of the plate. About three rings behind the plate assembly, the remaining bolts are inserted using pins or a pry bar to align the holes. After all bolts are in place, the nuts are tightened. Aligning of bolt holes is done easier when the bolts are loose while drifting of holes is best done with adjacent bolts tight.

Sometimes, tightening all of the bottom plate bolts as the bottom is assembled is desirable. If this procedure is done, certain plates are required to be properly aligned before tightening the bolts. Corner and top plates are always assembled with as few bolts as possible while initially assembling the structure.

The recommended range for bolt torque is between 100 and 300 foot-pounds. A balanced progression of tightening is maintained with respect to the axis of the structure, to prevent a spiraling tendency.