

ADA Transition Plan



Cass County Indiana

December 10, 2012

Completed by:



Union Station/300 S. Meridian St.
Indianapolis, IN 46225

ADA Checklist for Readily Achievable Barrier Removal

Priority 1 – Approach & Entrance



Project

Building Cass County Courthouse

Location Logansport, IN

Date 12-10-2012

Surveyors Henry Stellema & Dustin Schrougham

Contact Information 1-800-321-6959

An accessible route from site arrival points and an accessible entrance should be provided for everyone.



Institute for Human Centered Design
www.HumanCenteredDesign.org

November 2011



ADA National Network
Questions on the ADA 800-949-4232 voice/tty

www.ADAchecklist.org



This checklist was produced by the New England ADA Center, a project of the Institute for Human Centered Design and a member of the ADA National Network. This checklist was developed under a grant from the Department of Education, NIDRR grant number H133A060092-09A. However the contents do not necessarily represent the policy of the Department of Education, and you should not assume endorsement by the Federal Government.

Questions or comments on the checklist contact the New England ADA Center at 617-695-0085 voice/tty or ADAinfo@NewEnglandADA.org

For the full set of checklists, including the checklists for recreation facilities visit www.ADAchecklist.org.

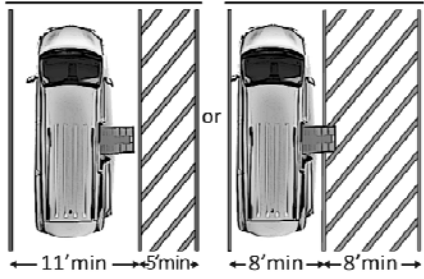
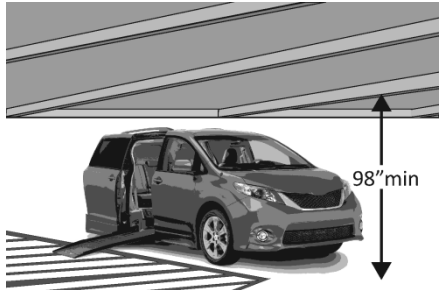
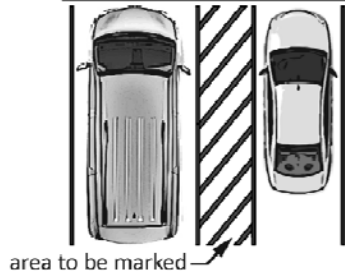
Priority 1 – Approach & Entrance		Comments	Possible Solutions												
<p>1.1 Is there at least one route from site arrival points (parking, passenger loading zones, public sidewalks and public transportation stops) that does not require the use of stairs?</p>	<p><input checked="" type="checkbox"/> Yes <input type="checkbox"/> No</p> <p>If yes, location of route:</p>														
<p>Parking (2010 Standards – 208 & 502) Note: Accessible parking spaces should be identified by size, access aisle and signage.</p>															
<p>1.2 If parking is provided for the public, are an adequate number of accessible spaces provided?</p>	<p><input checked="" type="checkbox"/> Yes <input type="checkbox"/> No</p> <p>Total #:34</p> <p>Accessible #: 3</p>	<table border="1"> <thead> <tr> <th>Total Spaces</th> <th>Accessible Spaces</th> </tr> </thead> <tbody> <tr> <td>1 - 25</td> <td>1</td> </tr> <tr> <td>26 - 50</td> <td>2</td> </tr> <tr> <td>51 - 75</td> <td>3</td> </tr> <tr> <td>76 - 100</td> <td>4</td> </tr> <tr> <td colspan="2">100+ see 2010 Standards 208.2</td> </tr> </tbody> </table>	Total Spaces	Accessible Spaces	1 - 25	1	26 - 50	2	51 - 75	3	76 - 100	4	100+ see 2010 Standards 208.2		
Total Spaces	Accessible Spaces														
1 - 25	1														
26 - 50	2														
51 - 75	3														
76 - 100	4														
100+ see 2010 Standards 208.2															
<p>1.3 Of the accessible spaces, is at least one a van accessible space?*</p>	<p><input checked="" type="checkbox"/> Yes <input type="checkbox"/> No</p>	<p>*For every 6 or fraction of 6 parking spaces required by the table above, at least 1 should be a van accessible space.</p>													
<p>1.4 Are accessible spaces at least 8 feet wide with an access aisle at least 5 feet wide?</p>	<p><input checked="" type="checkbox"/> Yes <input type="checkbox"/> No</p> <p>Measurement: 2 compliant & 1 non-compliant</p>	<p>← 8' min → → 5' min →</p>													

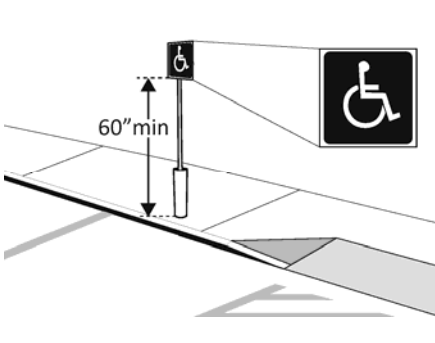

<p>1.5 Is the van accessible space:</p> <p>At least 11 feet wide with an access aisle at least 5 feet wide? Or At least 8 feet wide with an access aisle at least 8 feet wide?</p>	<p><input type="checkbox"/> Yes <input type="checkbox"/> No</p> <p>Measurement:</p> <p><input checked="" type="checkbox"/> Yes <input type="checkbox"/> No</p> <p>Measurement:</p>			
<p>1.6 Is at least 98 inches of vertical clearance provided for the van accessible space?</p>	<p><input checked="" type="checkbox"/> Yes <input type="checkbox"/> No</p> <p>Measurement:</p>			
<p>1.7 Are the access aisles marked so as to discourage parking in them?</p>	<p><input checked="" type="checkbox"/> Yes <input type="checkbox"/> No</p> <p>Measurement:</p>			
<p>1.8 Is the slope of the accessible parking spaces and access aisles no steeper than 1:48 in all directions?</p>	<p><input checked="" type="checkbox"/> Yes <input type="checkbox"/> No</p> <p>Measurement:</p>			

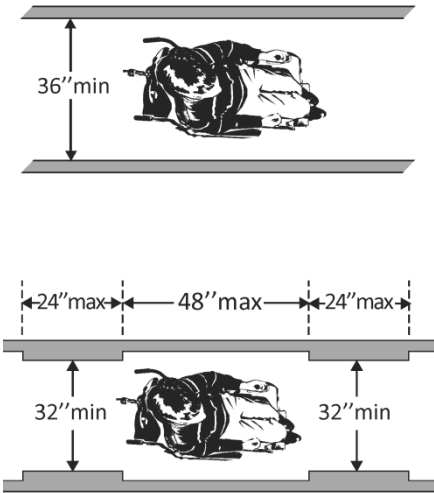
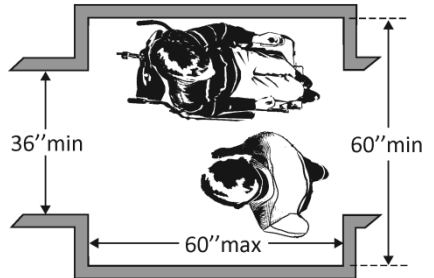

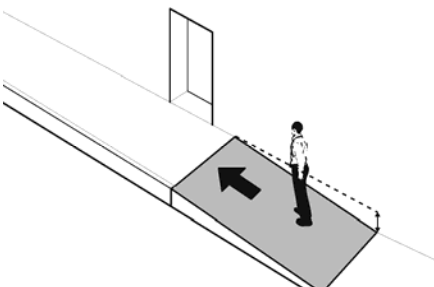
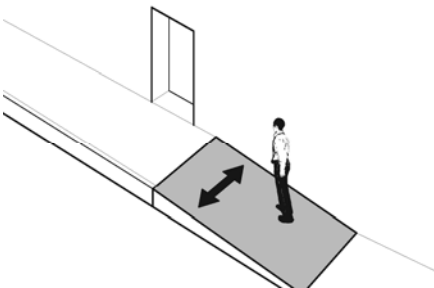
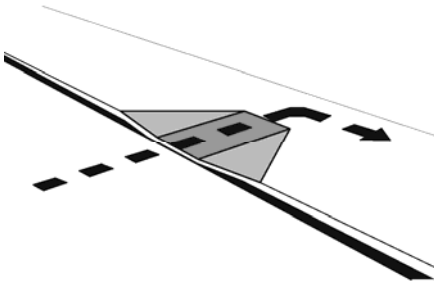
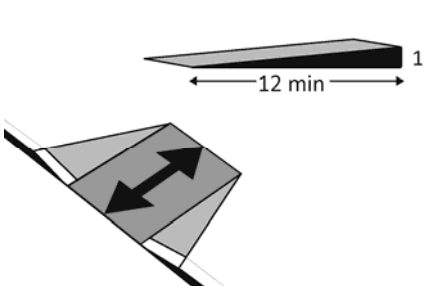
<p>1.9 Do the access aisles adjoin an accessible route?</p>	<p><input checked="" type="checkbox"/> Yes <input type="checkbox"/> No</p>			
<p>1.10 Are accessible spaces Identified with a sign that includes the International Symbol of Accessibility?</p> <p>Is the bottom of the sign at least 60 inches above the ground?</p>	<p><input type="checkbox"/> Yes <input checked="" type="checkbox"/> No</p> <p><input type="checkbox"/> Yes <input type="checkbox"/> No</p> <p>Measurement:</p>		 <p>Photo #001</p>	<ul style="list-style-type: none"> • Install signs
<p>1.11 Are there signs reading “van accessible” at van accessible spaces?</p>	<p><input type="checkbox"/> Yes <input checked="" type="checkbox"/> No</p>			<ul style="list-style-type: none"> • Install signs
<p>1.12 Of the total parking spaces, are the accessible spaces located on the closest accessible route to the accessible entrance(s)?</p>	<p><input checked="" type="checkbox"/> Yes <input type="checkbox"/> No</p>			

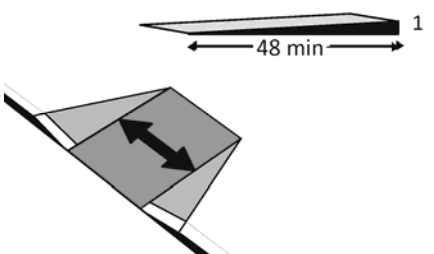
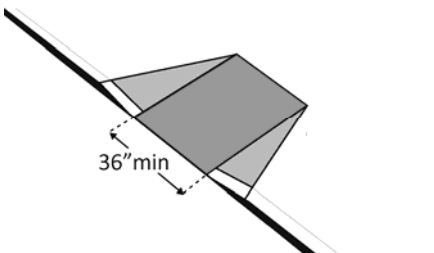
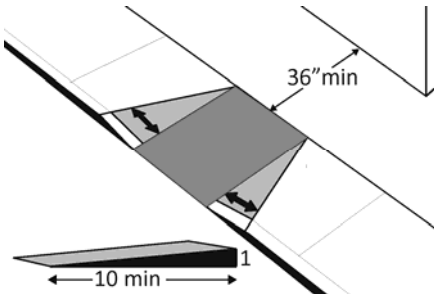
Exterior Accessible Route (2010 Standards – Ch.4)				
<p>1.13 Is the route stable, firm and slip-resistant?</p>	<p><input checked="" type="checkbox"/> Yes <input type="checkbox"/> No</p>			
<p>1.14 Is the route at least 36 inches wide?</p> <p>Note: The accessible route can narrow to 32 inches min. for a max. of 24 inches. These narrower portions of the route must be at least 48 inches from each other.</p>	<p><input checked="" type="checkbox"/> Yes <input type="checkbox"/> No</p> <p>Measurement:</p>	 <p>The diagram illustrates two scenarios for route width. The top scenario shows a wheelchair on a route with a minimum width of 36 inches. The bottom scenario shows a wheelchair on a route with a minimum width of 32 inches, with narrow sections of a maximum width of 24 inches. These narrow sections must be separated by sections that are at least 48 inches wide.</p>		
<p>1.15 If the route is greater than 200 feet in length and no less than 60 inches wide, is there a passing space no less than 60 x 60 inches?</p>	<p><input checked="" type="checkbox"/> Yes <input type="checkbox"/> No</p> <p>Measurement:</p>	 <p>The diagram shows a wheelchair on a passing space. The passing space is defined as a rectangular area that is at least 60 inches wide and 60 inches deep. The diagram shows a wheelchair positioned within this space, with a 36 inch minimum clearance on the left side.</p>		

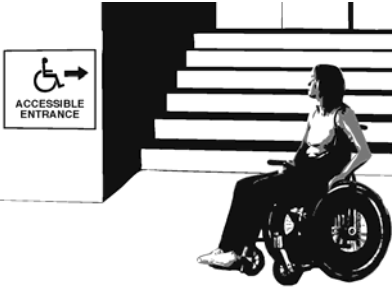
<p>1.17 Is the running slope no steeper than 1:20, i.e. for every inch of height change there are at least 20 inches of route run?</p>	<p><input checked="" type="checkbox"/> Yes <input type="checkbox"/> No</p> <p>Measurement:</p>			
<p>1.18 Is the cross slope no steeper than 1:48?</p>	<p><input checked="" type="checkbox"/> Yes <input type="checkbox"/> No</p> <p>Measurement:</p>			
<p>Curb Ramps (2010 Standards – 406)</p>				
<p>1.19 If the accessible route crosses a curb, is there a curb ramp?</p>	<p><input checked="" type="checkbox"/> Yes <input type="checkbox"/> No</p>			
<p>1.20 Is the running slope of the curb ramp no steeper than 1:12, i.e. for every inch of height change there are at least 12 inches of curb ramp run?</p>	<p><input checked="" type="checkbox"/> Yes <input type="checkbox"/> No</p> <p>Measurement:</p>			

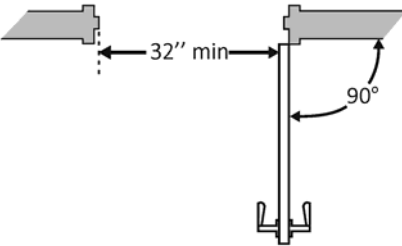
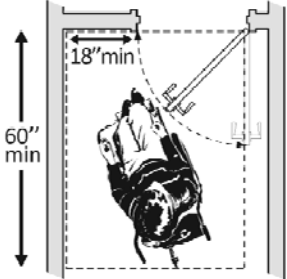
<p>1.21 Is the cross slope of the curb ramp, excluding flares, no steeper than 1:48?</p>	<p><input checked="" type="checkbox"/> Yes <input type="checkbox"/> No</p> <p>Measurement:</p>			
<p>1.22 Is the curb ramp, excluding flares, at least 36 inches wide?</p>	<p><input checked="" type="checkbox"/> Yes <input type="checkbox"/> No</p> <p>Measurement:</p>			
<p>1.23 At the top of the curb ramp is there a level landing (slope no steeper than 1:48 in all directions) that is at least 36 inches long and at least as wide as the curb ramp?</p> <p>If there are curb ramp flares, are the slopes of the flares no steeper than 1:10, i.e. for every inch of height change there are at least 10 inches of flare run?</p>	<p><input checked="" type="checkbox"/> Yes <input type="checkbox"/> No</p> <p>Measurement:</p> <p><input checked="" type="checkbox"/> Yes <input type="checkbox"/> No</p> <p>Measurement:</p>			
<p>Entrance (2010 Standards – 404)</p>				
<p>1.37 Is the main entrance accessible?</p>	<p><input checked="" type="checkbox"/> Yes <input type="checkbox"/> No</p>			

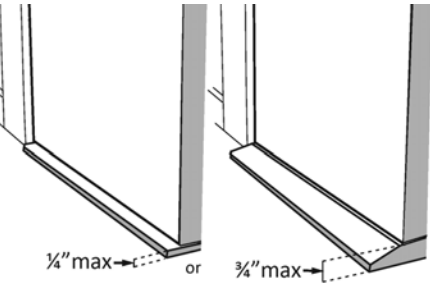
<p>1.39 Do all inaccessible entrances have signs indicating the location of the nearest accessible entrance?</p>	<p><input type="checkbox"/> Yes <input checked="" type="checkbox"/> No</p>		<ul style="list-style-type: none"> • Install signs 	
<p>1.40 If not all entrances are accessible, is there a sign at the accessible entrance with the International Symbol of Accessibility?</p>	<p><input checked="" type="checkbox"/> Yes <input type="checkbox"/> No</p>			
<p>1.41 Is the clear opening width of the accessible entrance door at least 32 inches, between the face of the door and the stop, when the door is open 90 degrees?</p>	<p><input checked="" type="checkbox"/> Yes <input type="checkbox"/> No</p> <p>Measurement:</p>			
<p>1.42 If there is a front approach to the pull side of the door, is there at least 18 inches of maneuvering clearance beyond the latch side plus at least 60 inches clear depth?</p> <p>On both sides of the door, is the ground or floor surface of the maneuvering clearance level (no steeper than 1:48)?</p>	<p><input checked="" type="checkbox"/> Yes <input type="checkbox"/> No</p> <p>Measurement:</p> <p><input type="checkbox"/> Yes <input type="checkbox"/> No</p> <p>Measurement:</p>			

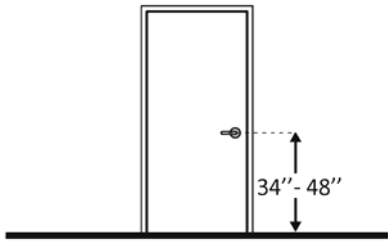
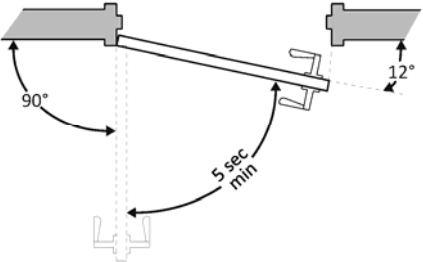
<p>1.43 Is the door threshold edge no more than ¼ inch high?</p> <p>Or</p> <p>No more than ¾ inch high if slope is beveled no steeper than 1:2?</p> <p>Note: The first ¼ inch of the threshold may be vertical; the rest must be beveled.</p>	<p><input checked="" type="checkbox"/> Yes <input type="checkbox"/> No</p> <p>Measurement:</p> <p><input checked="" type="checkbox"/> Yes <input type="checkbox"/> No</p> <p>Measurement:</p>			
<p>1.44 Is the door equipped with hardware, including locks, that is operable with one hand and does not require tight grasping, pinching, or twisting of the wrist?</p>	<p><input checked="" type="checkbox"/> Yes <input type="checkbox"/> No</p>			
<p>1.45 Are the operable parts of the door hardware no less than 34 inches and no greater than 48 inches above the floor or ground surface?</p>	<p><input checked="" type="checkbox"/> Yes <input type="checkbox"/> No</p> <p>Measurement:</p>			
<p>1.46 If the door has a closer, does it take at least 5 seconds to close from an open position of 90 degrees to a position of 12 degrees from the latch?</p>	<p><input checked="" type="checkbox"/> Yes <input type="checkbox"/> No</p> <p>Measurement:</p>			

<p>1.47 If there are two doors in a series, e.g. vestibule, is the distance between the doors at least 48 inches plus the width of the doors when swinging into the space?</p>	<p><input checked="" type="checkbox"/> Yes <input type="checkbox"/> No</p> <p>Measurement:</p>			
<p>1.48 If provided at the building entrance, are carpets or mats no higher than ½ inch thick?</p>	<p><input checked="" type="checkbox"/> Yes <input type="checkbox"/> No</p> <p>Measurement:</p>			

<p>1.49 Are edges of carpets or mats securely attached to minimize tripping hazards?</p>	<p><input type="checkbox"/> Yes <input checked="" type="checkbox"/> No</p>			<ul style="list-style-type: none"> • Secure carpeting or mats at edges
-------------------------------------------------------------------------------------------------	----------------------------------------------------------------------------	--	--	---------------------------------------------------------------------------------------

ADA Checklist for Readily Achievable Barrier Removal

Priority 2 – Access to Goods & Services

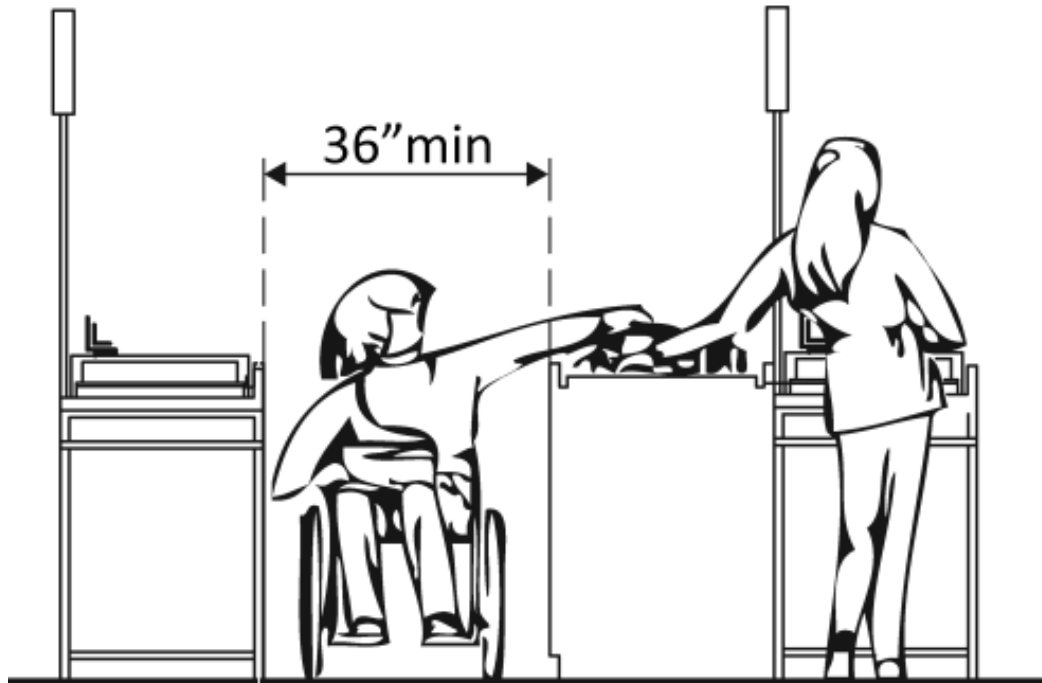

Project _____

Building _____

Location _____

Date _____

Surveyors _____

Contact Information _____

The layout of the building should allow people with disabilities to obtain goods and services and to participate in activities without assistance.



Institute for Human Centered Design
www.HumanCenteredDesign.org
November 2011





ADA National Network
Questions on the ADA 800-949-4232 voice/tty
www.ADAchecklist.org

This checklist was produced by the New England ADA Center, a project of the Institute for Human Centered Design and a member of the ADA National Network. This checklist was developed under a grant from the Department of Education, NIDRR grant number H133A060092-09A. However the contents do not necessarily represent the policy of the Department of Education, and you should not assume endorsement by the Federal Government.

Questions or comments on the checklist contact the New England ADA Center at 617-695-0085 voice/tty or ADAinfo@NewEnglandADA.org

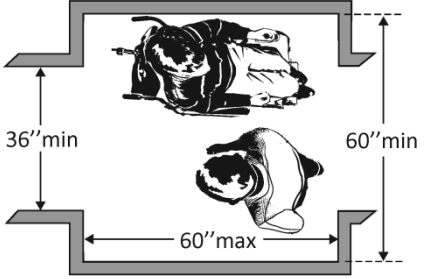
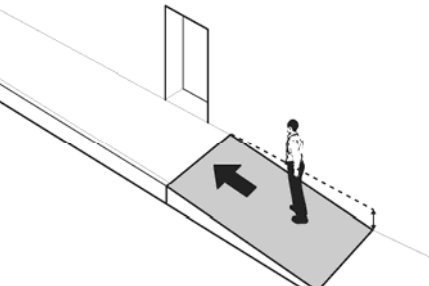
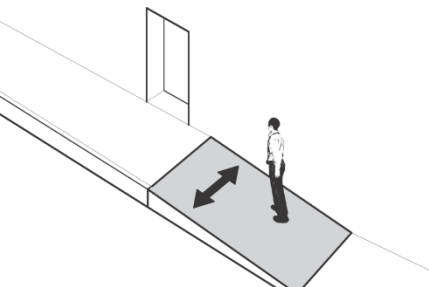

For the full set of checklists, including the checklists for recreation facilities visit www.ADAchecklist.org.

Priority 2 – Access to Goods & Services		Comments	Possible Solutions
<p>2.1 Does the accessible entrance provide direct access to the main floor, lobby and elevator?</p> <p><input checked="" type="checkbox"/> Yes <input type="checkbox"/> No</p>			
<p>Interior Accessible Route (2010 Standards – Ch.4)</p>			
<p>2.2 Are all public spaces on at least one accessible route?</p> <p><input checked="" type="checkbox"/> Yes <input type="checkbox"/> No</p>		<p>407 Clerk - no 12" on push</p> <p>Photo #:</p>	
<p>2.3 Is the route stable, firm and slip-resistant?</p> <p><input checked="" type="checkbox"/> Yes <input type="checkbox"/> No</p>			
<p>2.4 Is the route at least 36 inches wide?</p> <p>Note: The accessible route can narrow to 32 inches min. for a max. of 24 inches. These narrower portions of the route must be at least 48 inches from each other.</p> <p>Measurement:</p>	<p>The diagram illustrates two scenarios for wheelchair width. The top scenario shows a wheelchair between two parallel lines with a vertical double-headed arrow indicating a minimum width of 36 inches. The bottom scenario shows a wheelchair between two parallel lines with a vertical double-headed arrow indicating a minimum width of 32 inches. Above the wheelchair, three horizontal double-headed arrows indicate narrow sections: two 24-inch maximum sections on the ends and a 48-inch maximum section in the middle.</p>	<p>3rd & 4th Floor cross corridor doors are too narrow</p>	

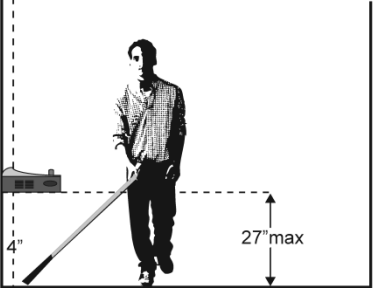
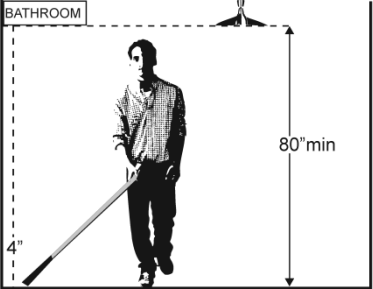
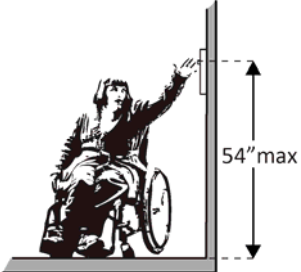
<p>2.5 If the route is greater than 200 feet in length and no less than 36 inches wide, is there a passing space no less than 60 x 60 inches?</p>	<p><input checked="" type="checkbox"/> Yes <input type="checkbox"/> No</p> <p>Measurement:</p>			
<p>2.6 Is the running slope no steeper than 1:20, i.e. for every inch of height change there are at least 20 inches of route run?</p>	<p><input checked="" type="checkbox"/> Yes <input type="checkbox"/> No</p> <p>Measurement:</p>			
<p>2.7 Is the cross slope no steeper than 1:48?</p>	<p><input checked="" type="checkbox"/> Yes <input type="checkbox"/> No</p> <p>Measurement:</p>			
<p>2.8 Do all objects on circulation paths through public areas, e.g. fire extinguishers, drinking fountains, signs, etc., protrude no more than 4 inches into the path? Or If an object protrudes more than 4 inches, is the bottom leading edge at 27 inches or lower above the floor?</p>	<p><input checked="" type="checkbox"/> Yes <input type="checkbox"/> No</p> <p>Measurement:</p> <p><input type="checkbox"/> Yes <input type="checkbox"/> No</p> <p>Measurement:</p>	 <p style="text-align: center;">Or</p>		

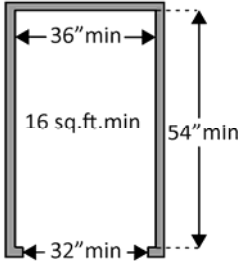
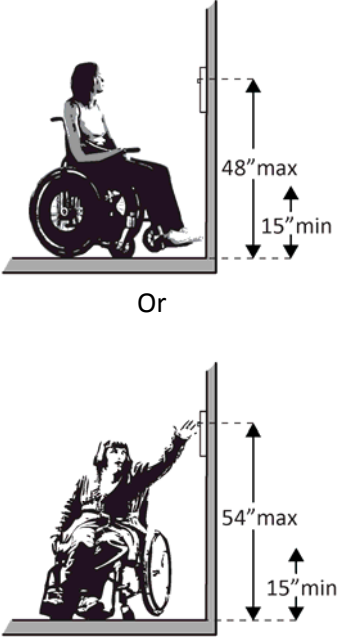
<p>Or Is the bottom leading edge at 80 inches or higher above the floor?</p>	<p><input type="checkbox"/> Yes <input type="checkbox"/> No Measurement:</p>	 <p>Or</p> 		
<p>2.9 Are there elevators or platform lifts to all public stories?*</p>	<p><input checked="" type="checkbox"/> Yes <input type="checkbox"/> No</p>			
<p>Elevators – Full Size & LULA (limited use, limited application) (2010 Standards – 407 & 408) Note: LULA elevators are often used in alterations.</p>				
<p>2.22 If there is a full size or LULA elevator, are the call buttons no higher than 54 inches above the floor?</p>	<p><input checked="" type="checkbox"/> Yes <input type="checkbox"/> No Measurement: 44</p>			

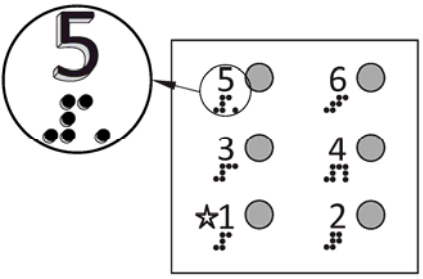
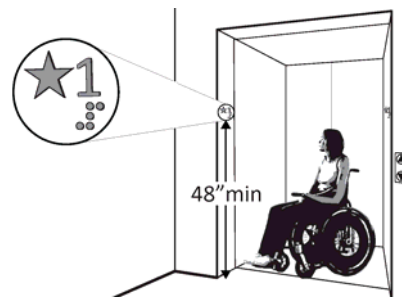
<p>2.23 If there is a full size or LULA elevator, does the sliding door reopen automatically when obstructed by an object or person?*</p>	<p><input checked="" type="checkbox"/> Yes <input type="checkbox"/> No</p>		
<p>2.25 If there is a full size elevator:</p> <p>Is the interior at least 54 inches deep by at least 36 inches wide with at least 16 sq. ft. of clear floor area?</p> <p>Is the door opening width at least 32 inches?</p>	<p><input type="checkbox"/> Yes <input checked="" type="checkbox"/> No</p> <p>Measurement: 50" d x 80" w</p> <p><input checked="" type="checkbox"/> Yes <input type="checkbox"/> No</p> <p>Measurement:</p>		<ul style="list-style-type: none"> • Replace elevator
<p>2.27 If there is a full size or LULA elevator, are the in-car controls:</p> <p>No less than 15 inches and no greater 48 inches above the floor?</p> <p>Or</p> <p>Up to 54 inches above the floor for a parallel approach?</p>	<p><input type="checkbox"/> Yes <input checked="" type="checkbox"/> No</p> <p>Measurement: 57"</p> <p><input type="checkbox"/> Yes <input type="checkbox"/> No</p> <p>Measurement:</p>		<ul style="list-style-type: none"> • Change control height

<p>2.29 If there is a full size or LULA elevator:</p> <p>Are the car control buttons designated with raised characters?</p> <p>Are the car control buttons designated with Braille?</p>	<p><input type="checkbox"/> Yes <input checked="" type="checkbox"/> No</p> <p><input type="checkbox"/> Yes <input checked="" type="checkbox"/> No</p>		<ul style="list-style-type: none"> • Add raised characters • Add Braille
<p>2.30 If there is a full size or LULA elevator, are there audible signals which sound as the car passes or is about to stop at a floor?</p>	<p><input type="checkbox"/> Yes <input checked="" type="checkbox"/> No</p>		<ul style="list-style-type: none"> • Install audible signals
<p>2.31 If there is a full size or LULA elevator:</p> <p>Is there a sign on both door jambs at every floor identifying the floor?</p> <p>Is there a tactile star on both jambs at the main entry level?</p> <p>Do text characters contrast with their backgrounds?</p> <p>Are text characters raised?</p> <p>Is there Braille?</p> <p>Is the sign mounted between 48 inches to the baseline of the lowest character and 60 inches to the baseline of the highest character above the floor?*</p>	<p><input type="checkbox"/> Yes <input checked="" type="checkbox"/> No</p> <p><input type="checkbox"/> Yes <input checked="" type="checkbox"/> No</p> <p><input checked="" type="checkbox"/> Yes <input type="checkbox"/> No</p> <p><input checked="" type="checkbox"/> Yes <input type="checkbox"/> No</p> <p><input checked="" type="checkbox"/> Yes <input type="checkbox"/> No</p> <p><input checked="" type="checkbox"/> Yes <input type="checkbox"/> No</p> <p>Measurement:</p>		 <p>Photo #002</p> <ul style="list-style-type: none"> • Install signs

Signs (2010 Standards – 703) Note: “Tactile characters” are read using touch, i.e. raised characters and Braille.

2.38 If there are signs designating permanent rooms and spaces not likely to change over time, e.g. room numbers and letters, room names, and exit signs:

Do text characters contrast with their backgrounds?

Yes No

Are text characters raised?

Yes No

Is there Braille?

Yes No

Is the sign mounted:
On the wall on the latch side of the door?

Yes No

Note:

Signs are permitted on the push side of doors with closers and without hold-open devices.

Yes No

With clear floor space beyond the arc of the door swing between the closed position and 45-degree open position, at least 18 x 18 inches centered on the tactile characters?*

Measurement:

Yes No

So the baseline of the lowest character is at least 48 inches above the floor and the baseline of the highest character is no more than 60

Measurement:

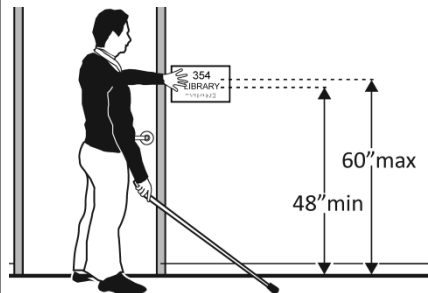
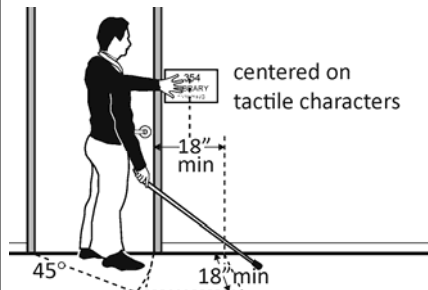
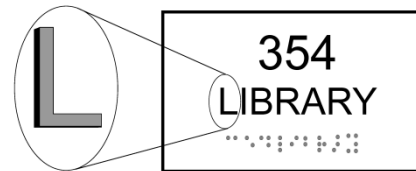

inches above the floor? *

Note:

If the sign is at double doors with one active leaf, the sign should be on the inactive leaf; if both leaves are active, the sign should be on the wall to the right of the right leaf.

Interior Doors – to classrooms, medical exam rooms, conference rooms, etc. (2010 Standards – 404)

2.40 Is the door opening width at least 32 inches clear, between the face of the door and the stop, when the door is open 90 degrees?

Yes No

Measurement:

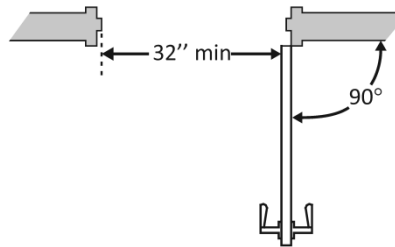

2.41 If there is a front approach to the pull side of the door, is there at least 18 inches of maneuvering clearance beyond the latch side plus at least 60 inches clear depth?

Yes No

Measurement:

Yes No

Measurement:

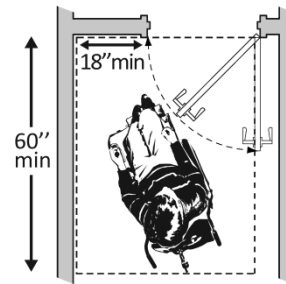

Auditor's Office - counter too close to door

Assessor's Office - 17" to wall @ election storage room 106A

- Remove obstructions
- Reconfigure walls
- Add automatic door opener

See 2010 Standards 404.2.4 for maneuvering clearance requirements on the push side of the door and side approaches to the pull side of the door

Courtrooms (2010 Standards –808)			
<p>2.106 Do all elevated platforms have a 60” turn around?</p>	<p><input type="checkbox"/> Yes <input checked="" type="checkbox"/> No</p> <p>Measurement:</p>		<p>Existing elevated platforms in Circuit Court Room 210 are too small for turn around.</p> <ul style="list-style-type: none"> • Provide alternate accommodations for the disabled.
<p>2.107 Are jury and witness boxes provided with a 30”x48” clear space?</p>	<p><input checked="" type="checkbox"/> Yes <input type="checkbox"/> No</p>		
<p>2.108 Do judge’s bench and associated work stations comply with items 2.66-2.67?</p>	<p><input checked="" type="checkbox"/> Yes <input type="checkbox"/> No</p>		

The ADA Checklist for Readily Achievable Barrier Removal

Priority 3 - Toilet Rooms

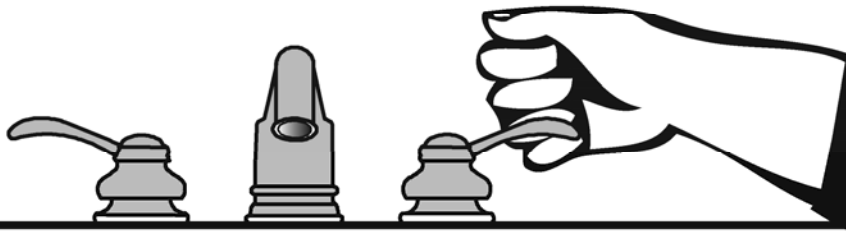

Project

Building

Location

Date

Surveyors

Contact Information

When toilet rooms are open to the public they should be accessible to people with disabilities.



Institute for Human Centered Design
www.HumanCenteredDesign.org
November 2011





ADA National Network
Questions on the ADA 800-949-4232 voice/tty
www.ADAchecklist.org

This checklist was produced by the New England ADA Center, a project of the Institute for Human Centered Design and a member of the ADA National Network. This checklist was developed under a grant from the Department of Education, NIDRR grant number H133A060092-09A. However the contents do not necessarily represent the policy of the Department of Education, and you should not assume endorsement by the Federal Government.

Questions or comments on the checklist contact the New England ADA Center at 617-695-0085 voice/tty or ADAinfo@NewEnglandADA.org

For the full set of checklists, including the checklists for recreation facilities visit www.ADAchecklist.org.

Priority 3 – Toilet Rooms			Comments	Possible Solutions
<p>3.1 If toilet rooms are available to the public, is at least one toilet room accessible? (Either one for each sex, or one unisex.)</p>	<input checked="" type="checkbox"/> Yes <input type="checkbox"/> No		<p>2nd Floor is most compliant</p> <p>1st, 3rd & 4th Floor are entirely non-compliant</p> <p>Photo #:</p>	
<p>3.2 Are there signs at inaccessible toilet rooms that give directions to accessible toilet rooms?</p>	<input type="checkbox"/> Yes <input checked="" type="checkbox"/> No			<ul style="list-style-type: none"> • Install signs
<p>3.3 If not all toilet rooms are accessible, is there a sign at the accessible toilet room with the International Symbol of Accessibility?</p>	<input checked="" type="checkbox"/> Yes <input type="checkbox"/> No			
<p>Accessible Route (2010 Standards – Chapter 4)</p>				
<p>3.4 Is there a route to the accessible toilet room(s) that does not include the use of stairs?</p>	<input checked="" type="checkbox"/> Yes <input type="checkbox"/> No			
<p>Is the route accessible? (See Priority 2 Interior Accessible Route for specifics.)</p>	<input type="checkbox"/> Yes <input type="checkbox"/> No			

Signs at Toilet Rooms (2010 Standards – 703)

3.5 Do text characters contrast with their backgrounds?

Yes No

Are text characters raised?

Yes No

Is there Braille?

Yes No

Is the sign mounted:
On the wall on the latch side of the door?

Yes No

Note:

Signs are permitted on the push side of doors with closers and without hold-open devices.

With clear floor space beyond the arc of the door swing and 45-degree open position, at least 18 x 18 inches centered on the tactile characters? *

Yes No

Measurement:

So the baseline of the lowest character is at least 48 inches above the floor and the baseline of the highest character is no more than 60 inches above the floor? *

Yes No

Measurement:

Note:

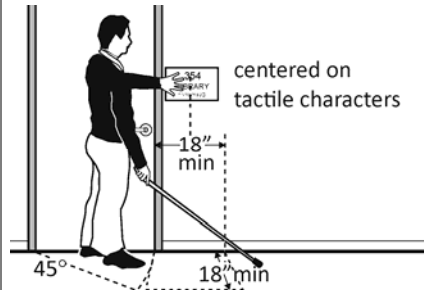
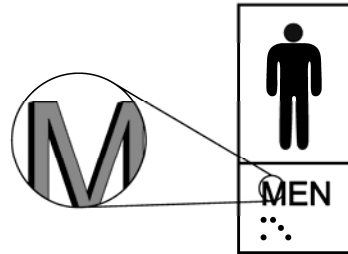

If the sign is at double doors with one active leaf, the sign



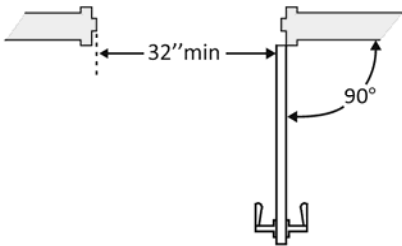
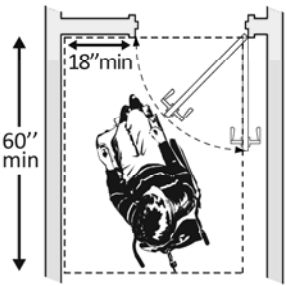
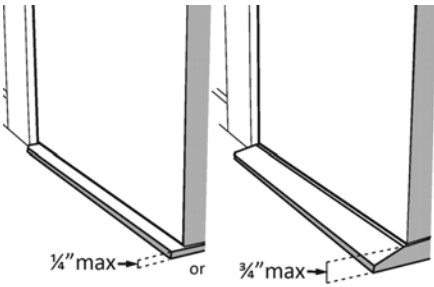

should be on the inactive leaf; if both leaves are active, the sign should be on the wall to the right of the right leaf.

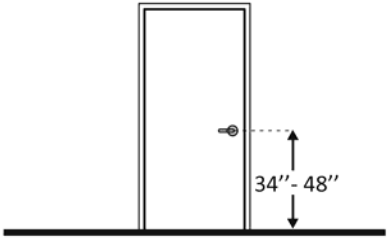
Entrance (2010 Standards – 404)

<p>3.6 Is the door opening width at least 32 inches clear, between the face of the door and the stop, when the door is open 90 degrees?</p> <p><input type="checkbox"/> Yes <input checked="" type="checkbox"/> No</p> <p>Measurement: 28"</p>	<p><input type="checkbox"/> Yes <input checked="" type="checkbox"/> No</p> <p>Measurement: 28"</p>			<ul style="list-style-type: none"> • Install offset hinges • Alter the doorway
<p>3.7 If there is a front approach to the pull side of the door is there at least 18 inches of maneuvering clearance beyond the latch side plus 60 inches clear depth?</p> <p>On both sides of the door, is the floor surface of the maneuvering clearance level (no steeper than 1:48)?</p> <p><input type="checkbox"/> Yes <input checked="" type="checkbox"/> No</p> <p>Measurement:</p>	<p><input checked="" type="checkbox"/> Yes <input type="checkbox"/> No</p> <p>Measurement:</p>		<p>@ 2nd Floor - Privacy partition is too close to door.</p>	<ul style="list-style-type: none"> • Remove obstructions <p>See 2010 Standards 404.2.4 for maneuvering clearance requirements on the push side of the door and side approaches to the pull side of the door</p>
<p>3.8 Is the door threshold edge no more than ¼ inch high?</p> <p>Or</p> <p>No more than ¾ inch high if slope is beveled no steeper than 1:2?</p> <p>Note: The first ¼ inch of the</p>	<p><input checked="" type="checkbox"/> Yes <input type="checkbox"/> No</p> <p>Measurement:</p> <p><input checked="" type="checkbox"/> Yes <input type="checkbox"/> No</p> <p>Measurement:</p>			

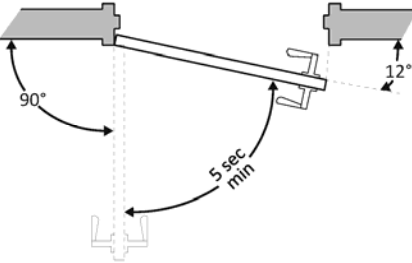
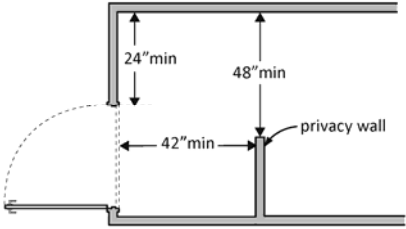
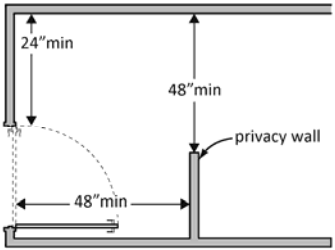
<p>threshold may be vertical; the rest must be beveled.</p>				
<p>3.9 Is the door equipped with hardware that is operable with one hand and does not require tight grasping, pinching, or twisting of the wrist? Check door handle and lock (if provided).</p>	<p><input checked="" type="checkbox"/> Yes <input type="checkbox"/> No Measurement:</p>			
<p>3.10 Are the operable parts of the door hardware mounted no less than 34 inches and no greater than 48 inches above the floor?</p>	<p><input checked="" type="checkbox"/> Yes <input type="checkbox"/> No Measurement:</p>			
<p>3.11 Can the door be opened easily (5 pounds maximum force)?</p>	<p><input checked="" type="checkbox"/> Yes <input type="checkbox"/> No Measurement:</p>			

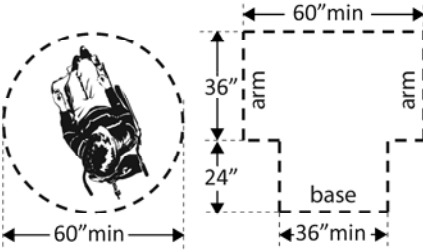
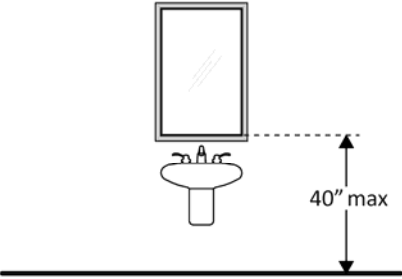

<p>3.12 If the door has a closer, does it take at least 5 seconds to close from an open position of 90 degrees to a position of 12 degrees from the latch?</p>	<p><input checked="" type="checkbox"/> Yes <input type="checkbox"/> No</p> <p>Measurement:</p>			
<p>3.14 If there is a privacy wall and the door swings out, is there at least 24 inches of maneuvering clearance beyond the door latch side and 42 inches to the privacy wall?</p>	<p><input checked="" type="checkbox"/> Yes <input type="checkbox"/> No</p> <p>Measurement:</p>			
<p>3.15 If there is a privacy wall and the door swings in, is there at least 24 inches of maneuvering clearance beyond the door latch side and at least 48 inches to the privacy wall if there is no door closer or at least 54 inches if there is a door closer?</p>	<p><input checked="" type="checkbox"/> Yes <input type="checkbox"/> No</p> <p>Measurement:</p>			
<p>In the Toilet Room</p>				
<p>3.16 Is there a clear path to at least one of each type of fixture, e.g. lavatory, hand dryer, etc., that is at least 36 inches wide?</p>	<p><input checked="" type="checkbox"/> Yes <input type="checkbox"/> No</p> <p>Measurement:</p>			

<p>3.17 Is there clear floor space available for a person in a wheelchair to turn around, i.e. a circle at least 60 inches in diameter or a T-shaped space within a 60-inch square?*</p>	<p><input checked="" type="checkbox"/> Yes <input type="checkbox"/> No</p> <p>Measurement:</p>			
<p>3.19 If the mirror is over a lavatory or countertop, is the bottom edge of the reflecting surface no higher than 40 inches above the floor? Or If the mirror is not over the lavatory or countertop, is the bottom edge of the reflecting surface no higher than 35 inches above the floor?*</p>	<p><input type="checkbox"/> Yes <input checked="" type="checkbox"/> No</p> <p>Measurement: 42"</p> <p><input type="checkbox"/> Yes <input type="checkbox"/> No</p> <p>Measurement:</p>			<p>•Lower mirror</p>

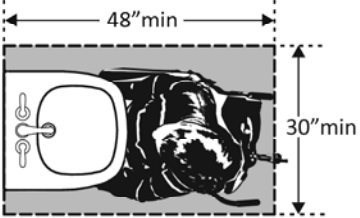
Lavatories (2010 Standards – 606) Note: 2010 Standards refer to sinks in toilet rooms as lavatories.

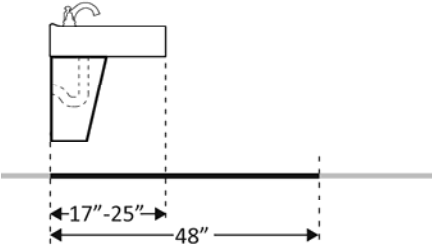
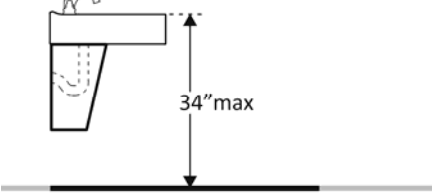
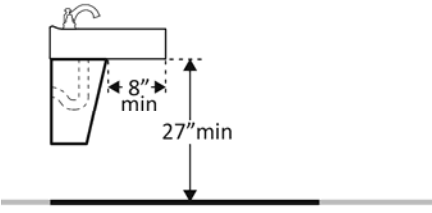
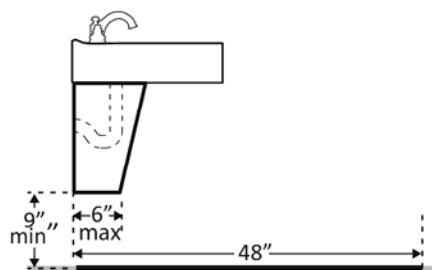
<p>3.21 Does at least one lavatory have a clear floor space for a forward approach at least 30 inches wide and 48 inches long?</p>	<p><input checked="" type="checkbox"/> Yes <input type="checkbox"/> No</p> <p>Measurement:</p>			
-------------------------------------------------------------------------------------------------------------------------------------------	------------------------------------------------------------------------------------------------	--------------------------------------------------------------------------------------	--	--

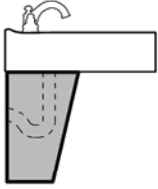
<p>3.22 Do no less than 17 inches and no greater than 25 inches of the clear floor space extend under the lavatory so that a person using a wheelchair can get close enough to reach the faucet?</p>	<p><input checked="" type="checkbox"/> Yes <input type="checkbox"/> No</p> <p>Measurement:</p>			
<p>3.23 Is the front of the lavatory or counter surface, whichever is higher, no more than 34 inches above the floor?</p>	<p><input checked="" type="checkbox"/> Yes <input type="checkbox"/> No</p> <p>Measurement: 32"</p>			
<p>3.24 Is there at least 27 inches clearance from the floor to the bottom of the lavatory that extends at least 8 inches under the lav for knee clearance?</p>	<p><input checked="" type="checkbox"/> Yes <input type="checkbox"/> No</p> <p>Measurement:</p>			
<p>3.25 Is there toe clearance at least 9 inches high?</p> <p>(Space extending greater than 6 inches beyond the available toe clearance at 9 inches above the floor is not considered toe clearance.)</p>	<p><input checked="" type="checkbox"/> Yes <input type="checkbox"/> No</p>			

<p>3.26 Are pipes below the lavatory insulated or otherwise configured to protect against contact?</p>	<p><input checked="" type="checkbox"/> Yes <input type="checkbox"/> No</p>			
<p>3.27 Can the faucet be operated without tight grasping, pinching, or twisting of the wrist?</p> <p>Is the force required to activate the faucet no greater than 5 pounds?</p>	<p><input checked="" type="checkbox"/> Yes <input type="checkbox"/> No</p> <p><input checked="" type="checkbox"/> Yes <input type="checkbox"/> No</p>			

Soap Dispensers and Hand Dryers (2010 Standards – 603)

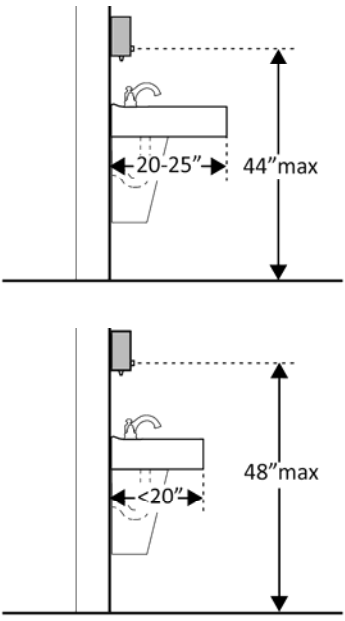
<p>3.28 Are the operable parts of the soap dispenser within one of the following reach ranges:</p> <p>Above lavatories or counters no less than 20 inches and no greater than 25 inches deep: no higher than 44 inches above the floor?</p> <p>Above lavatories less than 20 inches deep: no higher than 48 inches above the floor?</p> <p>Not over an obstruction: no higher than 48 inches above the</p>	<p><input type="checkbox"/> Yes <input type="checkbox"/> No Measurement:</p> <p><input checked="" type="checkbox"/> Yes <input type="checkbox"/> No Measurement:</p> <p><input type="checkbox"/> Yes <input type="checkbox"/> No Measurement:</p>			
-------------------------------------------------------------------------------------------------------------------------------------------------------------------------------------------------------------------------------------------------------------------------------------------------------------------------------------------------------------------------------------------------------------------	---------------------------------------------------------------------------------------------------------------------------------------------------------------------------------------------------------------------------------------------------------------	-------------------------------------------------------------------------------------	--	--

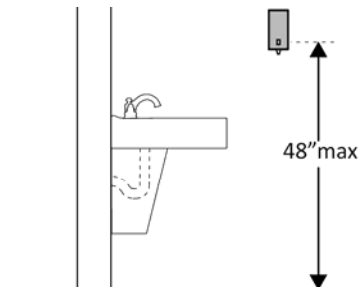
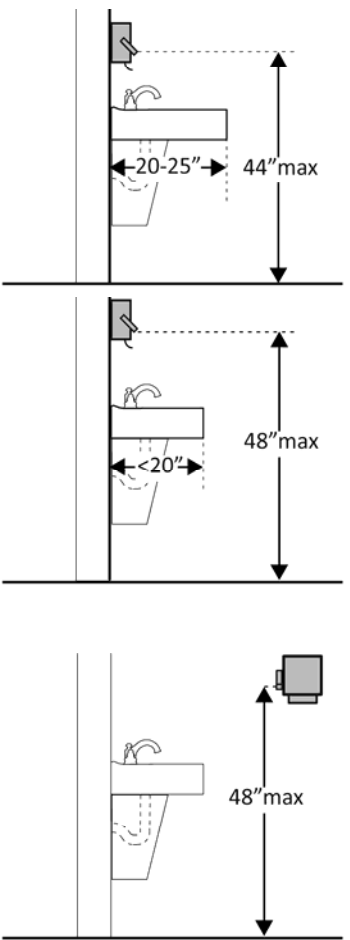
<p>floor?</p>				
<p>3.29 Are the operable parts of the hand dryer or towel dispenser within one of the following reach ranges:</p> <p>Above lavatories or counters no less than 20 inches and no greater than 25 inches deep: no higher than 44 inches above the floor?</p> <p>Above lavatories less than 20 inches deep: no higher than 48 inches above the floor?</p> <p>Not over an obstruction: no higher than 48 inches above the floor?</p> <p>Can the operable parts of the hand dryer or towel dispenser be operated without tight grasping, pinching or twisting of the wrist?</p> <p>Is the force required to activate the hand dryer or towel</p>	<p><input type="checkbox"/> Yes <input type="checkbox"/> No Measurement:</p> <p><input type="checkbox"/> Yes <input type="checkbox"/> No Measurement:</p> <p><input checked="" type="checkbox"/> Yes <input type="checkbox"/> No Measurement:</p> <p><input checked="" type="checkbox"/> Yes <input type="checkbox"/> No</p> <p><input type="checkbox"/> Yes <input type="checkbox"/> No</p>			

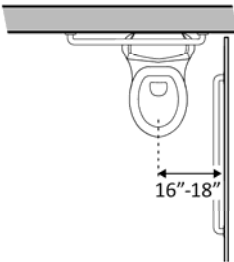
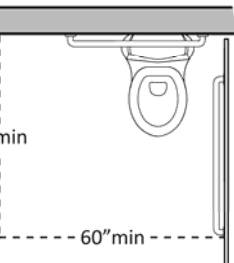
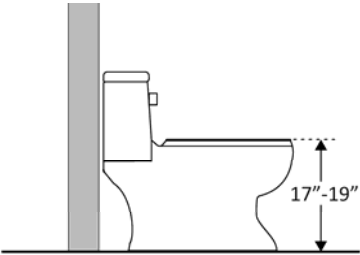
<p>dispenser no greater than 5 pounds?</p>	<p>Measurement:</p>			
<p>Water Closets in Single-User Toilet Rooms and Compartments (Stalls) (2010 Standards – 603 & 609) Note: 2010 Standards refer to toilets as water closets.</p>				
<p>3.30 Is the centerline of the water closet no less than 16 inches and no greater than 18 inches from the side wall or partition?</p>	<p><input checked="" type="checkbox"/> Yes <input type="checkbox"/> No Measurement:</p>			
<p>3.31 Is clearance provided around the water closet measuring at least 60 inches from the side wall and at least 56 inches from the rear wall?*</p>	<p><input checked="" type="checkbox"/> Yes <input type="checkbox"/> No Measurement:</p>			
<p>3.32 Is the height of the water closet no less than 17 inches and no greater than 19 inches above the floor measured to the top of the seat?</p>	<p><input checked="" type="checkbox"/> Yes <input type="checkbox"/> No Measurement:</p>			

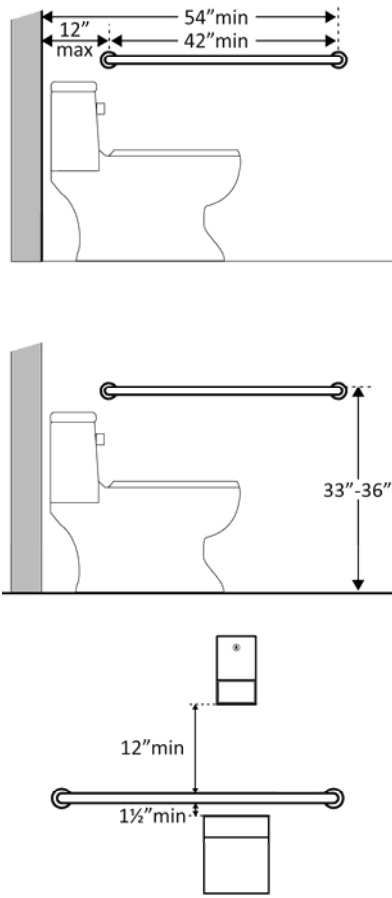
<p>3.33 Is there a grab bar at least 42 inches long on the side wall?</p> <p>Is it located no more than 12 inches from the rear wall?</p> <p>Does it extend at least 54 inches from the rear wall?</p> <p>Is it mounted no less than 33 inches and no greater than 36 inches above the floor to the top of the gripping surface?</p> <p>Is there at least 12 inches clearance between the grab bar and protruding objects above?*</p> <p>Is there at least 1½ inches clearance between the grab bar and projecting objects below?*</p> <p>Is the space between the wall and the grab bar 1 ½ inches?</p>	<p><input checked="" type="checkbox"/> Yes <input type="checkbox"/> No</p> <p>Measurement:</p> <p><input checked="" type="checkbox"/> Yes <input type="checkbox"/> No</p> <p>Measurement:</p> <p><input checked="" type="checkbox"/> Yes <input type="checkbox"/> No</p> <p>Measurement:</p> <p><input checked="" type="checkbox"/> Yes <input type="checkbox"/> No</p> <p>Measurement:</p> <p><input checked="" type="checkbox"/> Yes <input type="checkbox"/> No</p> <p>Measurement:</p> <p><input checked="" type="checkbox"/> Yes <input type="checkbox"/> No</p> <p>Measurement:</p>	 <p>The diagrams illustrate the following requirements for a side wall grab bar:</p> <ul style="list-style-type: none"> Length: The grab bar must be at least 42 inches long and no more than 54 inches long. Distance from Rear Wall: The grab bar must be located no more than 12 inches from the rear wall. Height: The grab bar must be mounted no less than 33 inches and no greater than 36 inches above the floor to the top of the gripping surface. Clearance Above: There must be at least 12 inches of clearance between the grab bar and any protruding objects above it. Clearance Below: There must be at least 1½ inches of clearance between the grab bar and any projecting objects below it. 		
-----------------------------------------------------------------------------------------------------------------------------------------------------------------------------------------------------------------------------------------------------------------------------------------------------------------------------------------------------------------------------------------------------------------------------------------------------------------------------------------------------------------------------------------------------------------------------------------------------------------	-------------------------------------------------------------------------------------------------------------------------------------------------------------------------------------------------------------------------------------------------------------------------------------------------------------------------------------------------------------------------------------------------------------------------------------------------------------------------------------------------------------------------------------------------------------------------------------------	-----------------------------------------------------------------------------------------------------------------------------------------------------------------------------------------------------------------------------------------------------------------------------------------------------------------------------------------------------------------------------------------------------------------------------------------------------------------------------------------------------------------------------------------------------------------------------------------------------------------------------------------------------------------------------------------------------------------------------------------------------------------------------------------------------------------------------------------------------------------------------------------	--	--

<p>3.34 Is there a grab bar at least 36 inches long on the rear wall?</p> <p>Does it extend at least 12 inches from the centerline of the water closet on one side (side wall)?</p> <p>Does it extend at least 24 inches on the other (open) side?</p> <p>Is it mounted no less than 33 inches and no greater than 36 inches above the floor to the top of the gripping surface?</p> <p>Are there at least 12 inches clearance between the grab bar and protruding objects above?*</p> <p>Are there at least 1½ inches clearance between the grab bar and projecting objects below?*</p> <p>Is the space between the wall and the grab bar 1 ½ inches?</p>	<p><input checked="" type="checkbox"/> Yes <input type="checkbox"/> No</p> <p>Measurement:</p> <p><input checked="" type="checkbox"/> Yes <input type="checkbox"/> No</p> <p>Measurement:</p> <p><input checked="" type="checkbox"/> Yes <input type="checkbox"/> No</p> <p>Measurement:</p> <p><input checked="" type="checkbox"/> Yes <input type="checkbox"/> No</p> <p>Measurement:</p> <p><input checked="" type="checkbox"/> Yes <input type="checkbox"/> No</p> <p>Measurement:</p> <p><input checked="" type="checkbox"/> Yes <input type="checkbox"/> No</p> <p>Measurement:</p>			
-------------------------------------------------------------------------------------------------------------------------------------------------------------------------------------------------------------------------------------------------------------------------------------------------------------------------------------------------------------------------------------------------------------------------------------------------------------------------------------------------------------------------------------------------------------------------------------------------------------------------------------------------------------------	-------------------------------------------------------------------------------------------------------------------------------------------------------------------------------------------------------------------------------------------------------------------------------------------------------------------------------------------------------------------------------------------------------------------------------------------------------------------------------------------------------------------------------------------------------------------------------------------	--	--	--

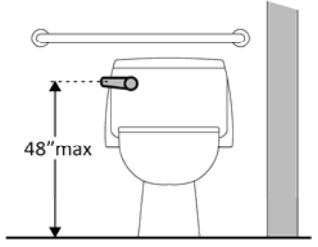
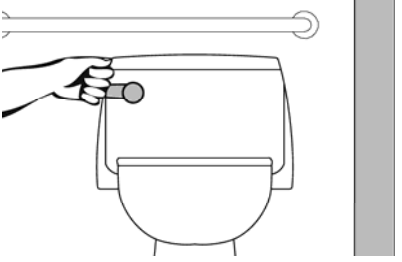
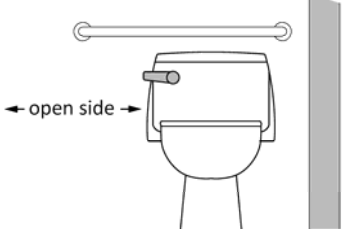
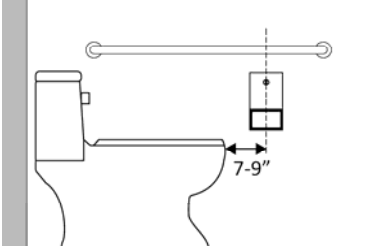
<p>3.35 If the flush control is hand operated, is the operable part located no higher than 48 inches above the floor?</p>	<p><input checked="" type="checkbox"/> Yes <input type="checkbox"/> No</p> <p>Measurement:</p>			
<p>3.36 If the flush control is hand operated, can it be operated with one hand and without tight grasping, pinching, or twisting of the wrist?</p> <p>Is the force required to activate the flush control no greater than 5 pounds?</p>	<p><input checked="" type="checkbox"/> Yes <input type="checkbox"/> No</p> <p><input type="checkbox"/> Yes <input type="checkbox"/> No</p> <p>Measurement:</p>			
<p>3.37 Is the flush control on the open side of the water closet?</p>	<p><input checked="" type="checkbox"/> Yes <input type="checkbox"/> No</p>			
<p>3.38 Is the toilet paper dispenser located no less than 7 inches and no greater than 9 inches from the front of the water closet to the centerline of the dispenser?*</p>	<p><input type="checkbox"/> Yes <input checked="" type="checkbox"/> No</p> <p>Measurement: 12"</p>			<ul style="list-style-type: none"> Relocate dispenser

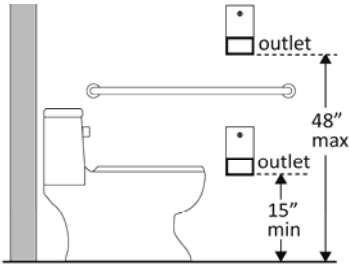
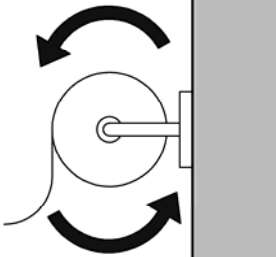
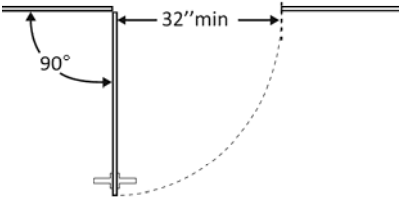
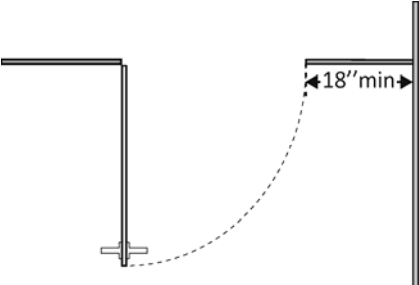
<p>3.39 Is the outlet of the dispenser:</p> <p>Located no less than 15 inches and no greater than 48 inches above the floor?</p> <p>Not located behind grab bars?</p>	<p><input checked="" type="checkbox"/> Yes <input type="checkbox"/> No</p> <p>Measurement:</p> <p><input checked="" type="checkbox"/> Yes <input type="checkbox"/> No</p>			
<p>3.40 Does the dispenser allow continuous paper flow?</p>	<p><input checked="" type="checkbox"/> Yes <input type="checkbox"/> No</p>			
<p>Toilet Compartments (Stalls) (2010 Standards – 604)</p>				
<p>3.41 Is the door opening width at least 32 inches clear, between the face of the door and the stop, when the door is open 90 degrees?</p>	<p><input checked="" type="checkbox"/> Yes <input type="checkbox"/> No</p> <p>Measurement:</p>		<p>Door needs to be located diagonally from toilet</p>	<ul style="list-style-type: none"> • Relocate door
<p>3.42 If there is a front approach to the pull side of the door, is there at least 18 inches of maneuvering clearance beyond the latch side plus 60 inches clear depth?*</p>	<p><input checked="" type="checkbox"/> Yes <input type="checkbox"/> No</p> <p>Measurement:</p>			

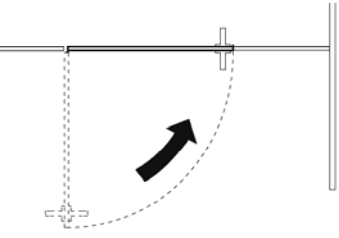
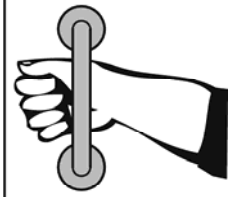
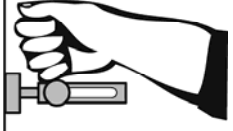
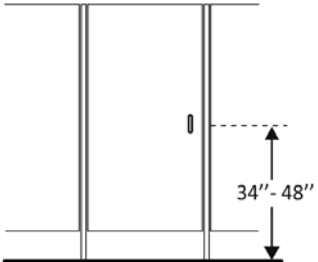
<p>3.43 Is the door self-closing?</p>	<p><input type="checkbox"/> Yes <input checked="" type="checkbox"/> No</p>		<ul style="list-style-type: none"> • Add closer
<p>3.44 Are there door pulls on both sides of the door that are operable with one hand and do not require tight grasping pinching or twisting of the wrist?*</p>	<p><input type="checkbox"/> Yes <input checked="" type="checkbox"/> No</p>		<ul style="list-style-type: none"> • Replace hardware
<p>3.45 Is the lock operable with one hand and without tight grasping, pinching or twisting of the wrist?</p>	<p><input checked="" type="checkbox"/> Yes <input type="checkbox"/> No</p>		
<p>3.46 Are the operable parts of the door hardware mounted no less than 34 inches and no greater than 48 inches above the floor?</p>	<p><input checked="" type="checkbox"/> Yes <input type="checkbox"/> No Measurement:</p>		

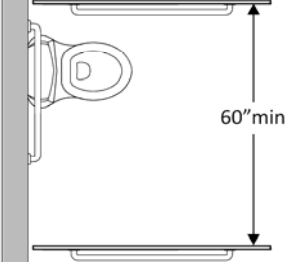
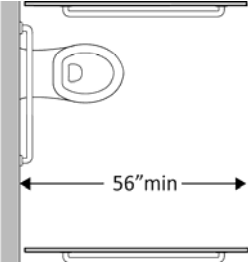
<p>3.47 Is the compartment at least 60 inches wide?</p>	<p><input checked="" type="checkbox"/> Yes <input type="checkbox"/> No</p> <p>Measurement:</p>			
<p>3.48 If the water closet is wall hung, is the compartment at least 56 inches deep?</p>	<p><input checked="" type="checkbox"/> Yes <input type="checkbox"/> No</p> <p>Measurement:</p>			
<p>3.51 Wall Hung Urinals installed with rim at 17in AFF? And 13-1/2in deep? With an 30in X 48in clear space?</p>	<p><input type="checkbox"/> Yes <input checked="" type="checkbox"/> No</p>		<p>19" AFF</p>	<ul style="list-style-type: none"> • Lower urinal

ADA Checklist for Readily Achievable Barrier Removal

Priority 4 – Additional Access

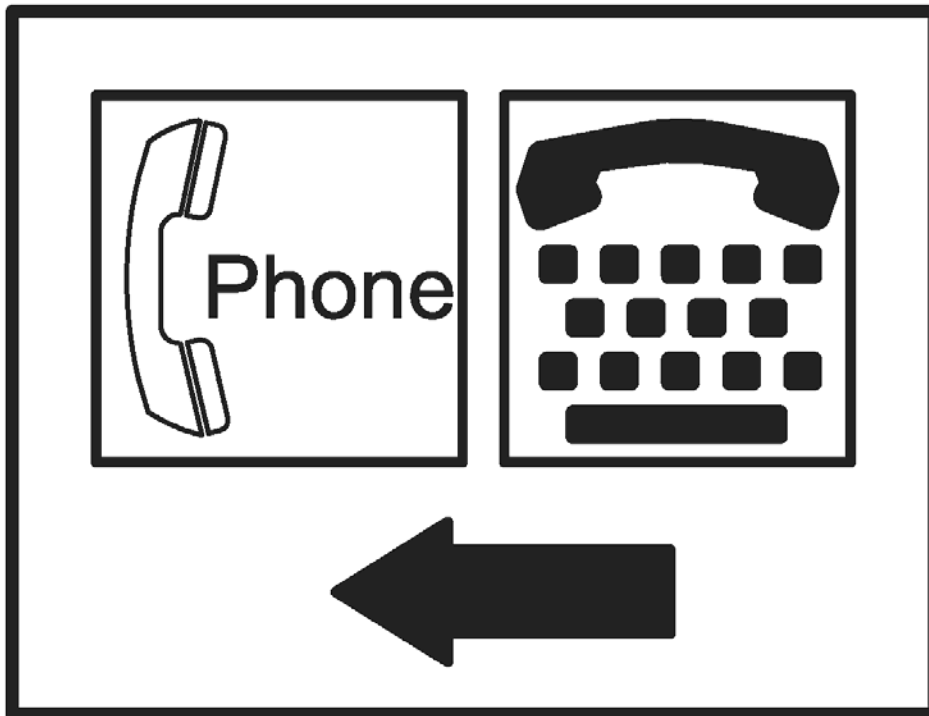

Project _____

Building _____

Location _____

Date _____

Surveyors _____

Contact Information _____

Amenities such as drinking fountains and public telephones should be accessible to people with disabilities.



Institute for Human Centered Design
www.HumanCenteredDesign.org
November 2011





ADA National Network
Questions on the ADA 800-949-4232 voice/tty
www.ADAchecklist.org

This checklist was produced by the New England ADA Center, a project of the Institute for Human Centered Design and a member of the ADA National Network. This checklist was developed under a grant from the Department of Education, NIDRR grant number H133A060092-09A. However the contents do not necessarily represent the policy of the Department of Education, and you should not assume endorsement by the Federal Government.



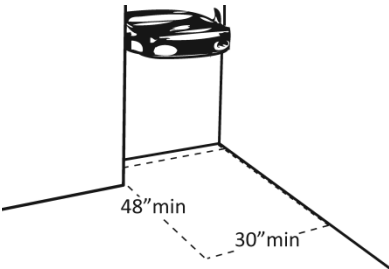
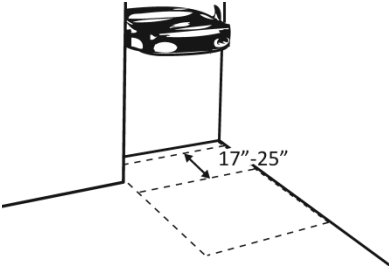
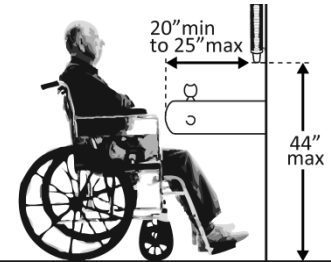

Questions or comments on the checklist contact the New England ADA Center at 617-695-0085 voice/tty or ADAinfo@NewEnglandADA.org

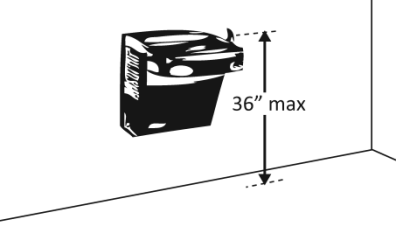
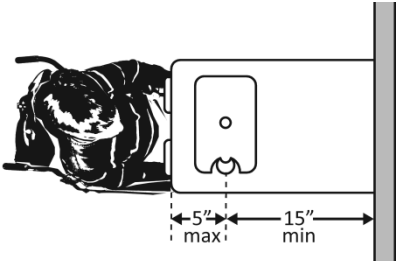
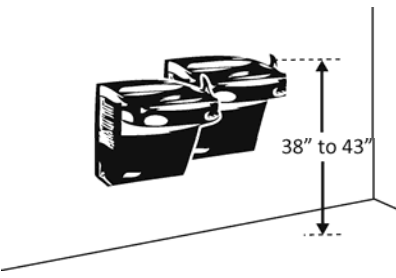
For the full set of checklists, including the checklists for recreation facilities visit www.ADAchecklist.org.

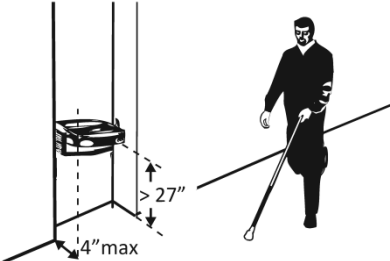
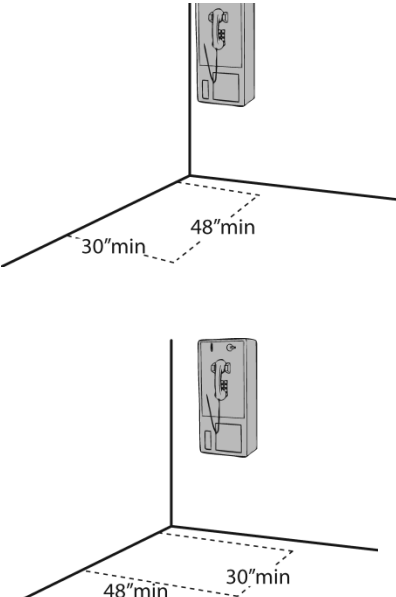
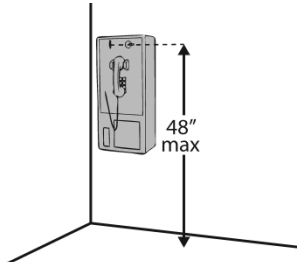
Priority 4 – Additional Access		Comments	Possible Solutions
Drinking Fountains (2010 Standards – 602)			
<p>4.1 Does at least one drinking fountain have a clear floor space at least 30 inches wide x at least 48 inches long centered in front of it for a forward approach?*</p>	<p><input type="checkbox"/> Yes <input checked="" type="checkbox"/> No</p> <p>Measurement:</p>		<ul style="list-style-type: none"> Alter space around drinking fountain
<p>4.2 If there is a forward approach, do no less than 17 inches and no greater than 25 inches of the clear floor space extend under the drinking fountain?</p>	<p><input checked="" type="checkbox"/> Yes <input type="checkbox"/> No</p> <p>Measurement:</p>		
<p>4.4 If the drinking fountain is no less than 20 inches and no greater than 25 inches deep, are the operable parts no higher than 44 inches above the floor?</p>	<p><input checked="" type="checkbox"/> Yes <input type="checkbox"/> No</p> <p>Measurement:</p>		

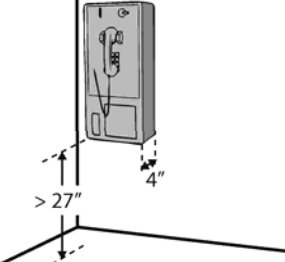
<p>4.5 Can the control be operated with one hand and without tight grasping, pinching or twisting of the wrist?</p> <p>Is the force required to activate the control no more than 5 pounds?</p>	<p><input checked="" type="checkbox"/> Yes <input type="checkbox"/> No</p> <p><input checked="" type="checkbox"/> Yes <input type="checkbox"/> No</p> <p>Measurement:</p>			
<p>4.6 Is the spout outlet no higher than 36 inches above the floor?</p>	<p><input checked="" type="checkbox"/> Yes <input type="checkbox"/> No</p> <p>Measurement:</p>			
<p>4.7 Is the spout:</p> <p>At least 15 inches from the rear of the drinking fountain?</p> <p>No more than 5 inches from the front of the drinking fountain?</p>	<p><input checked="" type="checkbox"/> Yes <input type="checkbox"/> No</p> <p>Measurement:</p> <p><input checked="" type="checkbox"/> Yes <input type="checkbox"/> No</p> <p>Measurement:</p>			
<p>4.8 If there is more than one drinking fountain, is there at least one for standing persons?</p> <p>Is the spout outlet no lower than 38 inches and no higher than 43 inches above the floor?</p>	<p><input checked="" type="checkbox"/> Yes <input type="checkbox"/> No</p> <p><input checked="" type="checkbox"/> Yes <input type="checkbox"/> No</p> <p>Measurement:</p>			

<p>4.9 If the leading (bottom) edge of the fountain is higher than 27 inches above the floor, does the front of the fountain protrude no more than 4 inches into the circulation path?</p>	<p><input checked="" type="checkbox"/> Yes <input type="checkbox"/> No</p> <p>Measurement:</p>			
<p>Public Telephones (2010 Standards – 704) TTY's are devices that employ interactive text-based communication through the transmission of coded signals across the telephone network. They are mainly used by people who are deaf and/or cannot speak.</p>				
<p>4.10 Does at least one telephone have a clear floor space at least 30 inches wide x at least 48 inches long for a parallel or forward approach?</p>	<p><input checked="" type="checkbox"/> Yes <input type="checkbox"/> No</p>			
<p>4.11 Is the highest operable part of the telephone no higher than 48 inches above the floor?</p>	<p><input type="checkbox"/> Yes <input checked="" type="checkbox"/> No</p> <p>Measurement: 60"</p>			<ul style="list-style-type: none"> • Adjust telephone

<p>4.12 If the leading (bottom) edge of the telephone is higher than 27 inches above the floor, does the front of the telephone protrude no more than 4 inches into the circulation path?</p>	<p><input type="checkbox"/> Yes <input checked="" type="checkbox"/> No</p> <p>Measurement:</p>		<ul style="list-style-type: none"> • Adjust telephone
<p>4.13 Does at least one telephone have a volume control?</p>	<p><input checked="" type="checkbox"/> Yes <input type="checkbox"/> No</p>		
<p>4.14 Is the volume control identified by a pictogram of a telephone handset with radiating sound waves?</p>	<p><input checked="" type="checkbox"/> Yes <input type="checkbox"/> No</p>		
<p>4.15 Does at least one telephone have a TTY?</p>	<p><input type="checkbox"/> Yes <input checked="" type="checkbox"/> No</p>		<ul style="list-style-type: none"> • Install TTY

<p>4.16 Is the touch surface of the TTY keypad at least 34 inches above the floor?</p>	<p><input type="checkbox"/> Yes <input checked="" type="checkbox"/> No Measurement:</p>			
<p>4.17 Is the TTY identified by the International Symbol of TTY?</p>	<p><input type="checkbox"/> Yes <input checked="" type="checkbox"/> No</p>			
<p>4.18 Do signs that provide direction to public telephones also provide direction to the TTY?</p>	<p><input type="checkbox"/> Yes <input checked="" type="checkbox"/> No</p>			<ul style="list-style-type: none"> • Add signs
<p>4.19 Do telephones that do not have a TTY provide direction to the TTY?</p>	<p><input type="checkbox"/> Yes <input checked="" type="checkbox"/> No</p>			<ul style="list-style-type: none"> • Add signs



Photo #001

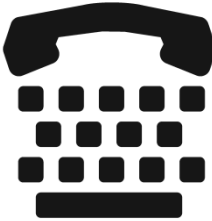
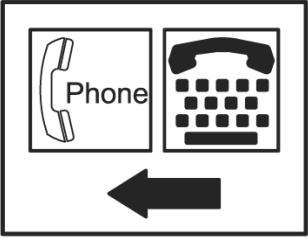
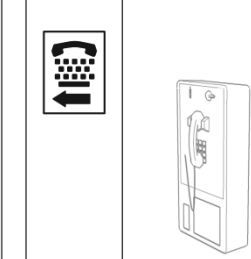

Photo #002

ADA Checklist for Readily Achievable Barrier Removal

Priority 1 – Approach & Entrance



Project Cass County ADA Transition Plan

Building Family Opportunity Center

Location Logansport, IN

Date 12-10-2012

Surveyors Henry Stellema & Dustin Schrougham

Contact Information 1-800-321-6959

An accessible route from site arrival points and an accessible entrance should be provided for everyone.



Institute for Human Centered Design
www.HumanCenteredDesign.org

November 2011



ADA National Network
Questions on the ADA 800-949-4232 voice/tty

www.ADAchecklist.org



This checklist was produced by the New England ADA Center, a project of the Institute for Human Centered Design and a member of the ADA National Network. This checklist was developed under a grant from the Department of Education, NIDRR grant number H133A060092-09A. However the contents do not necessarily represent the policy of the Department of Education, and you should not assume endorsement by the Federal Government.

Questions or comments on the checklist contact the New England ADA Center at 617-695-0085 voice/tty or ADAinfo@NewEnglandADA.org

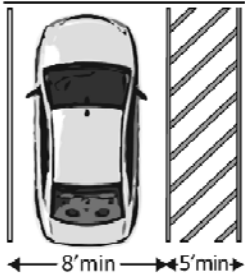

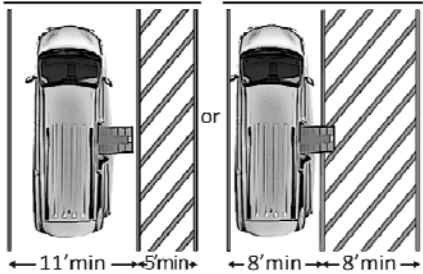
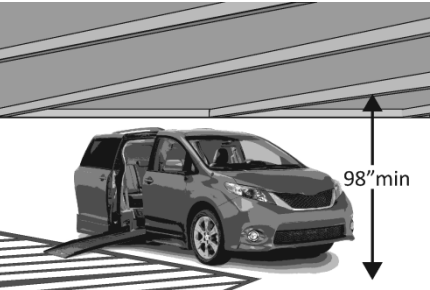
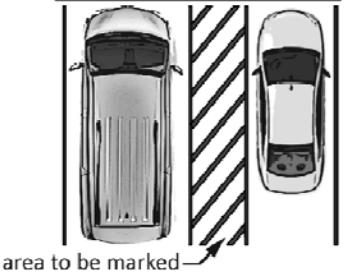
For the full set of checklists, including the checklists for recreation facilities visit www.ADAchecklist.org.

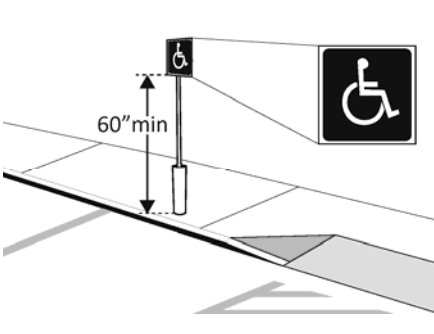
Priority 1 – Approach & Entrance		Comments	Possible Solutions												
<p>1.1 Is there at least one route from site arrival points (parking, passenger loading zones, public sidewalks and public transportation stops) that does not require the use of stairs?</p>	<p><input checked="" type="checkbox"/> Yes <input type="checkbox"/> No</p> <p>If yes, location of route:</p>														
<p>1.2 If parking is provided for the public, are an adequate number of accessible spaces provided?</p>	<p><input checked="" type="checkbox"/> Yes <input type="checkbox"/> No</p> <p>Total #:16</p> <p>Accessible #: 1</p> <table border="1"> <thead> <tr> <th>Total Spaces</th> <th>Accessible Spaces</th> </tr> </thead> <tbody> <tr> <td>1 - 25</td> <td>1</td> </tr> <tr> <td>26 - 50</td> <td>2</td> </tr> <tr> <td>51 - 75</td> <td>3</td> </tr> <tr> <td>76 - 100</td> <td>4</td> </tr> <tr> <td>100+ see 2010 Standards 208.2</td> <td></td> </tr> </tbody> </table>	Total Spaces	Accessible Spaces	1 - 25	1	26 - 50	2	51 - 75	3	76 - 100	4	100+ see 2010 Standards 208.2			
Total Spaces	Accessible Spaces														
1 - 25	1														
26 - 50	2														
51 - 75	3														
76 - 100	4														
100+ see 2010 Standards 208.2															
<p>1.3 Of the accessible spaces, is at least one a van accessible space?*</p>	<p><input type="checkbox"/> Yes <input checked="" type="checkbox"/> No</p>	<p>*For every 6 or fraction of 6 parking spaces required by the table above, at least 1 should be a van accessible space.</p>  <p>Photo #001</p>	<ul style="list-style-type: none"> Reconfigure by repainting lines 												
<p>1.4 Are accessible spaces at least 8 feet wide with an access aisle at least 5 feet wide?</p>	<p><input type="checkbox"/> Yes <input checked="" type="checkbox"/> No</p> <p>Measurement:</p>		<ul style="list-style-type: none"> Reconfigure by repainting lines <p>Two spaces can share an access aisle (check state requirements)</p>												

<p>1.5 Is the van accessible space:</p> <p>At least 11 feet wide with an access aisle at least 5 feet wide? Or At least 8 feet wide with an access aisle at least 8 feet wide?</p>	<p><input type="checkbox"/> Yes <input checked="" type="checkbox"/> No</p> <p>Measurement:</p> <p><input type="checkbox"/> Yes <input checked="" type="checkbox"/> No</p> <p>Measurement:</p>			<ul style="list-style-type: none"> • Reconfigure to provide van-accessible space(s)
<p>1.6 Is at least 98 inches of vertical clearance provided for the van accessible space?</p>	<p><input checked="" type="checkbox"/> Yes <input type="checkbox"/> No</p> <p>Measurement:</p>			
<p>1.7 Are the access aisles marked so as to discourage parking in them?</p>	<p><input type="checkbox"/> Yes <input checked="" type="checkbox"/> No</p> <p>Measurement:</p>			<ul style="list-style-type: none"> • Mark access aisles <p>The marking method and color may be addressed by state/local requirements</p>
<p>1.8 Is the slope of the accessible parking spaces and access aisles no steeper than 1:48 in all directions?</p>	<p><input checked="" type="checkbox"/> Yes <input type="checkbox"/> No</p> <p>Measurement:</p>			

<p>1.9 Do the access aisles adjoin an accessible route?</p>	<p><input checked="" type="checkbox"/> Yes <input type="checkbox"/> No</p>			
<p>1.10 Are accessible spaces Identified with a sign that includes the International Symbol of Accessibility? Is the bottom of the sign at least 60 inches above the ground?</p>	<p><input checked="" type="checkbox"/> Yes <input type="checkbox"/> No <input type="checkbox"/> Yes <input checked="" type="checkbox"/> No Measurement:</p>			<ul style="list-style-type: none"> • Move signs <p>The International Symbol of Accessibility is not required on the ground by the 2010 Standards</p>
<p>1.11 Are there signs reading “van accessible” at van accessible spaces?</p>	<p><input type="checkbox"/> Yes <input checked="" type="checkbox"/> No</p>			<ul style="list-style-type: none"> • Install signs
<p>1.12 Of the total parking spaces, are the accessible spaces located on the closest accessible route to the accessible entrance(s)?</p>	<p><input checked="" type="checkbox"/> Yes <input type="checkbox"/> No</p>			

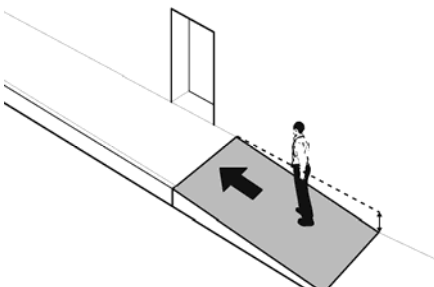
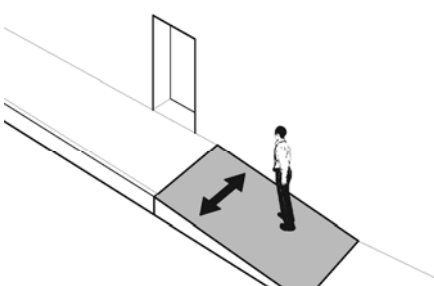
Exterior Accessible Route (2010 Standards – Ch.4)				
<p>1.13 Is the route stable, firm and slip-resistant?</p>	<p><input type="checkbox"/> Yes <input checked="" type="checkbox"/> No</p>			<ul style="list-style-type: none"> • Replace gravel with asphalt or other surface
<p>1.14 Is the route at least 36 inches wide?</p> <p>Note: The accessible route can narrow to 32 inches min. for a max. of 24 inches. These narrower portions of the route must be at least 48 inches from each other.</p>	<p><input checked="" type="checkbox"/> Yes <input type="checkbox"/> No</p> <p>Measurement:</p>	<p>The diagram illustrates two measurement scenarios for a wheelchair on a route. The top diagram shows a standard width measurement of 36 inches minimum. The bottom diagram shows a narrow section measurement of 32 inches minimum, with narrow sections limited to a maximum of 24 inches and separated by a maximum of 48 inches.</p>		
<p>1.15 If the route is greater than 200 feet in length and no less than 60 inches wide, is there a passing space no less than 60 x 60 inches?</p>	<p><input checked="" type="checkbox"/> Yes <input type="checkbox"/> No</p> <p>Measurement:</p>	<p>The diagram shows a passing space for two wheelchairs. The top diagram indicates a 36-inch minimum width for the route. The bottom diagram shows a passing space that is 60 inches maximum in width and 60 inches minimum in length.</p>		

<p>1.17 Is the running slope no steeper than 1:20, i.e. for every inch of height change there are at least 20 inches of route run?</p>	<p><input checked="" type="checkbox"/> Yes <input type="checkbox"/> No</p> <p>Measurement:</p>			
<p>1.18 Is the cross slope no steeper than 1:48?</p>	<p><input checked="" type="checkbox"/> Yes <input type="checkbox"/> No</p> <p>Measurement:</p>			
<p>Entrance (2010 Standards – 404)</p>				
<p>1.37 Is the main entrance accessible?</p>	<p><input checked="" type="checkbox"/> Yes <input type="checkbox"/> No</p>			
<p>1.39 Do all inaccessible entrances have signs indicating the location of the nearest accessible entrance?</p>	<p><input type="checkbox"/> Yes <input checked="" type="checkbox"/> No</p>			<ul style="list-style-type: none"> • Install signs

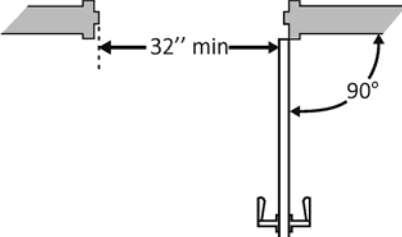
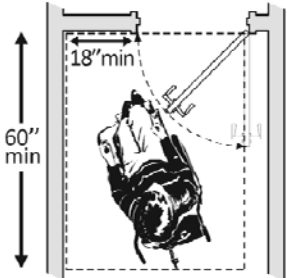
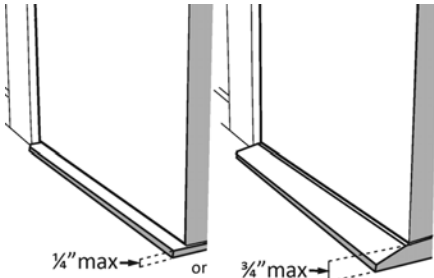
<p>1.40 If not all entrances are accessible, is there a sign at the accessible entrance with the International Symbol of Accessibility?</p>	<p><input type="checkbox"/> Yes <input checked="" type="checkbox"/> No</p>		<ul style="list-style-type: none"> • Install sign
<p>1.41 Is the clear opening width of the accessible entrance door at least 32 inches, between the face of the door and the stop, when the door is open 90 degrees?</p>	<p><input checked="" type="checkbox"/> Yes <input type="checkbox"/> No Measurement:</p>		
<p>1.42 If there is a front approach to the pull side of the door, is there at least 18 inches of maneuvering clearance beyond the latch side plus at least 60 inches clear depth?</p> <p>On both sides of the door, is the ground or floor surface of the maneuvering clearance level (no steeper than 1:48)?</p>	<p><input checked="" type="checkbox"/> Yes <input type="checkbox"/> No Measurement:</p> <p><input checked="" type="checkbox"/> Yes <input type="checkbox"/> No Measurement:</p>		
<p>1.43 Is the door threshold edge no more than ¼ inch high?</p> <p>Or</p> <p>No more than ¾ inch high if slope is beveled no steeper than 1:2?</p>	<p><input checked="" type="checkbox"/> Yes <input type="checkbox"/> No Measurement:</p> <p><input checked="" type="checkbox"/> Yes <input type="checkbox"/> No Measurement:</p>		

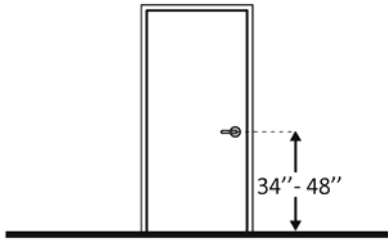
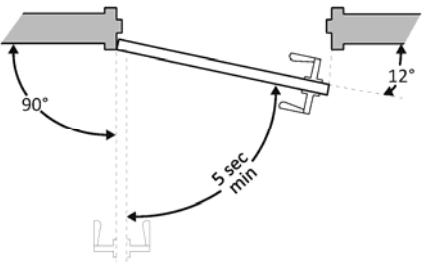
<p>Note: The first ¼ inch of the threshold may be vertical; the rest must be beveled.</p>				
<p>1.44 Is the door equipped with hardware, including locks, that is operable with one hand and does not require tight grasping, pinching, or twisting of the wrist?</p>	<p><input checked="" type="checkbox"/> Yes <input type="checkbox"/> No</p>			
<p>1.45 Are the operable parts of the door hardware no less than 34 inches and no greater than 48 inches above the floor or ground surface?</p>	<p><input checked="" type="checkbox"/> Yes <input type="checkbox"/> No Measurement:</p>			
<p>1.46 If the door has a closer, does it take at least 5 seconds to close from an open position of 90 degrees to a position of 12 degrees from the latch?</p>	<p><input checked="" type="checkbox"/> Yes <input type="checkbox"/> No Measurement:</p>			

<p>1.47 If there are two doors in a series, e.g. vestibule, is the distance between the doors at least 48 inches plus the width of the doors when swinging into the space?</p>	<p><input checked="" type="checkbox"/> Yes <input type="checkbox"/> No</p> <p>Measurement:</p>			
<p>1.48 If provided at the building entrance, are carpets or mats no higher than ½ inch thick?</p>	<p><input checked="" type="checkbox"/> Yes <input type="checkbox"/> No</p> <p>Measurement:</p>			

1.49 Are edges of carpets or mats securely attached to minimize tripping hazards?	<input checked="" type="checkbox"/> Yes <input type="checkbox"/> No			
------------------------------------------------------------------------------------------	---------------------------------------------------------------------	--	--	--

ADA Checklist for Readily Achievable Barrier Removal

Priority 2 – Access to Goods & Services

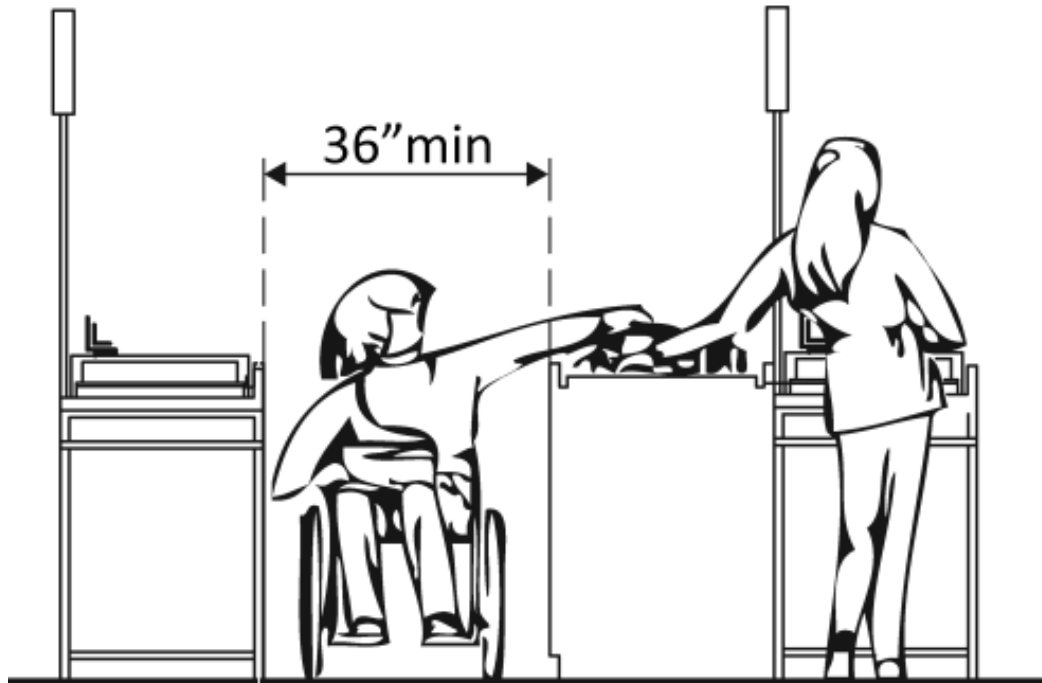

Project _____

Building _____

Location _____

Date _____

Surveyors _____

Contact Information _____

The layout of the building should allow people with disabilities to obtain goods and services and to participate in activities without assistance.



Institute for Human Centered Design
www.HumanCenteredDesign.org
November 2011





ADA National Network
Questions on the ADA 800-949-4232 voice/tty
www.ADAchecklist.org

This checklist was produced by the New England ADA Center, a project of the Institute for Human Centered Design and a member of the ADA National Network. This checklist was developed under a grant from the Department of Education, NIDRR grant number H133A060092-09A. However the contents do not necessarily represent the policy of the Department of Education, and you should not assume endorsement by the Federal Government.

Questions or comments on the checklist contact the New England ADA Center at 617-695-0085 voice/tty or ADAinfo@NewEnglandADA.org

For the full set of checklists, including the checklists for recreation facilities visit www.ADAchecklist.org.

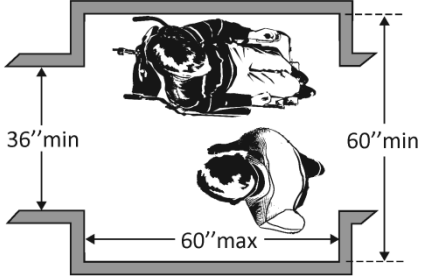
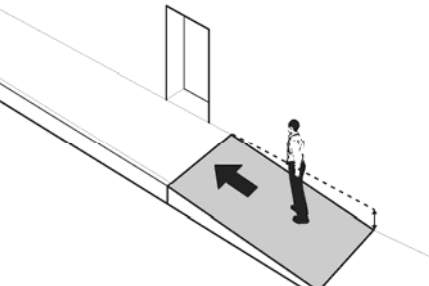
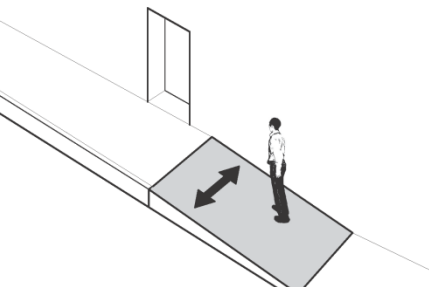
Priority 2 – Access to Goods & Services		Comments	Possible Solutions
<p>2.1 Does the accessible entrance provide direct access to the main floor, lobby and elevator?</p> <p><input checked="" type="checkbox"/> Yes <input type="checkbox"/> No</p>			
<p>Interior Accessible Route (2010 Standards – Ch.4)</p>			
<p>2.2 Are all public spaces on at least one accessible route?</p> <p><input checked="" type="checkbox"/> Yes <input type="checkbox"/> No</p>			
<p>2.3 Is the route stable, firm and slip-resistant?</p> <p><input checked="" type="checkbox"/> Yes <input type="checkbox"/> No</p>			
<p>2.4 Is the route at least 36 inches wide?</p> <p><input type="checkbox"/> Yes <input checked="" type="checkbox"/> No</p> <p>Note: The accessible route can narrow to 32 inches min. for a max. of 24 inches. These narrower portions of the route must be at least 48 inches from each other.</p>	<p>Measurement:</p>	<p>Corridor to accessible toilet is too narrow.</p>	<ul style="list-style-type: none"> Widen route

<p>2.5 If the route is greater than 200 feet in length and no less than 36 inches wide, is there a passing space no less than 60 x 60 inches?</p>	<p><input checked="" type="checkbox"/> Yes <input type="checkbox"/> No</p> <p>Measurement:</p>			
<p>2.6 Is the running slope no steeper than 1:20, i.e. for every inch of height change there are at least 20 inches of route run?</p>	<p><input checked="" type="checkbox"/> Yes <input type="checkbox"/> No</p> <p>Measurement:</p>			
<p>2.7 Is the cross slope no steeper than 1:48?</p>	<p><input checked="" type="checkbox"/> Yes <input type="checkbox"/> No</p> <p>Measurement:</p>			
<p>2.8 Do all objects on circulation paths through public areas, e.g. fire extinguishers, drinking fountains, signs, etc., protrude no more than 4 inches into the path? Or If an object protrudes more than 4 inches, is the bottom leading edge at 27 inches or lower above the floor?</p>	<p><input checked="" type="checkbox"/> Yes <input type="checkbox"/> No</p> <p>Measurement:</p> <p><input type="checkbox"/> Yes <input type="checkbox"/> No</p> <p>Measurement:</p>	 <p style="text-align: center;">Or</p>		

Or
Is the bottom leading edge at 80 inches or higher above the floor?

Yes No

Measurement:

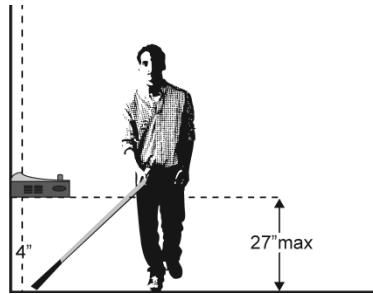

Or

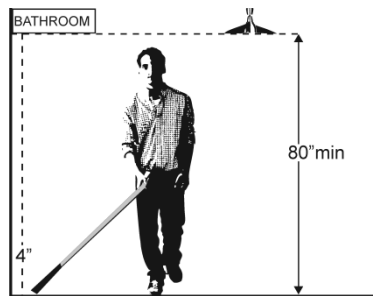



Interior Doors – to classrooms, medical exam rooms, conference rooms, etc. (2010 Standards – 404)

2.40 Is the door opening width at least 32 inches clear, between the face of the door and the stop, when the door is open 90 degrees?

Yes No

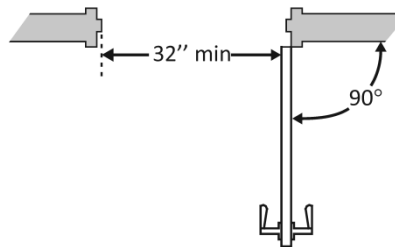
Measurement:

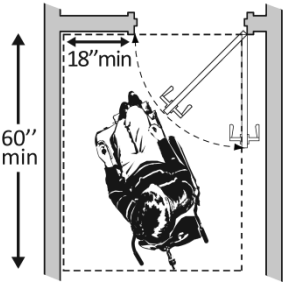
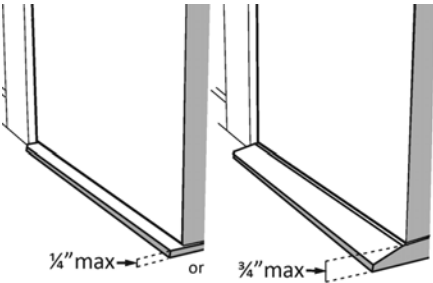

<p>2.41 If there is a front approach to the pull side of the door, is there at least 18 inches of maneuvering clearance beyond the latch side plus at least 60 inches clear depth?</p> <p>On both sides of the door, is the floor surface of the maneuvering clearance level (no steeper than 1:48)?</p>	<p><input type="checkbox"/> Yes <input checked="" type="checkbox"/> No</p> <p>Measurement:</p> <p><input checked="" type="checkbox"/> Yes <input type="checkbox"/> No</p> <p>Measurement:</p>			<ul style="list-style-type: none"> Remove obstructions <p>See 2010 Standards 404.2.4 for maneuvering clearance requirements on the push side of the door and side approaches to the pull side of the door</p>
<p>2.42 Is the door threshold edge no more than ¼ inch high?</p> <p>Or</p> <p>No more than ¾ inch high if slope is beveled no steeper than 1:2?</p> <p>Note: The first ¼ inch of the threshold may be vertical; the rest must be beveled.</p>	<p><input checked="" type="checkbox"/> Yes <input type="checkbox"/> No</p> <p>Measurement:</p> <p><input checked="" type="checkbox"/> Yes <input type="checkbox"/> No</p> <p>Measurement:</p>			
<p>2.43 Is the door equipped with hardware that is operable with one hand and does not require tight grasping, pinching and twisting of the wrist?</p>	<p><input checked="" type="checkbox"/> Yes <input type="checkbox"/> No</p>			

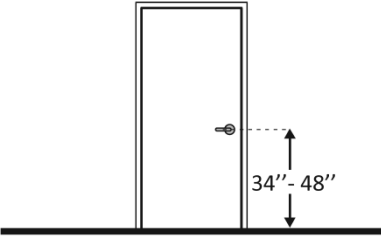
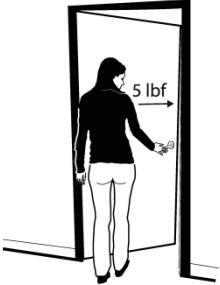
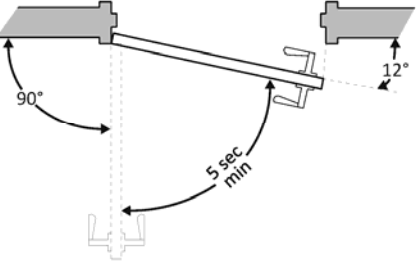
<p>2.44 Are the operable parts of the hardware no less than 34 inches and no greater than 48 inches above the floor?</p>	<p><input checked="" type="checkbox"/> Yes <input type="checkbox"/> No</p> <p>Measurement:</p>			
<p>2.45 Can the door be opened easily (5 pounds maximum force)?</p> <p>Note: You can use a pressure gauge or fish scale to measure force. If you do not have a pressure gauge or fish scale you will need to judge whether the door is easy to open.</p>	<p><input checked="" type="checkbox"/> Yes <input type="checkbox"/> No</p> <p>Measurement:</p>			
<p>2.46 If the door has a closer, does it take at least 5 seconds to close from an open position of 90 degrees to a position of 12 degrees from the latch?</p>	<p><input checked="" type="checkbox"/> Yes <input type="checkbox"/> No</p> <p>Measurement:</p>			

Controls – light switches, security and intercom systems, emergency/alarm boxes, etc. (2010 Standards – 309)

2.50 Is there a clear floor space at least 30 inches wide by at least 48 inches long for a forward or parallel approach?

Yes No

Measurement:

Are the operable parts no higher than 48 inches above the floor?*

Yes No

Measurement:

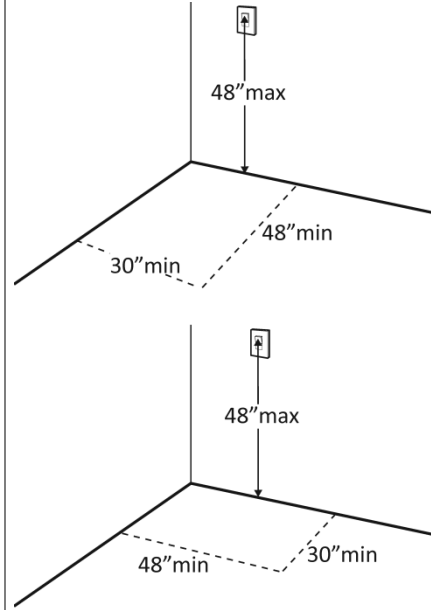

• Relocate controls

2.51 Can the control be operated with one hand and without tight grasping, pinching, or twisting of the wrist?

Yes No

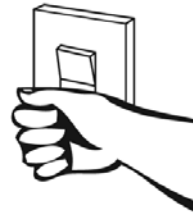

• Replace control

Seating: General – reception areas, waiting rooms, etc. (2010 Standards – 801)



2.68 Is there at least one space at least 36 inches wide by at least 48 inches long for a person in a wheelchair?

Yes No

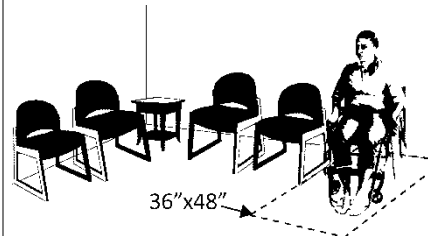
Measurement:

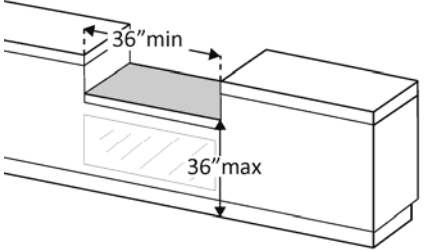

Sales & Service Counters – banks, stores, dry cleaners, auto repair shops, fitness clubs, etc. (2010 Standards – 904)

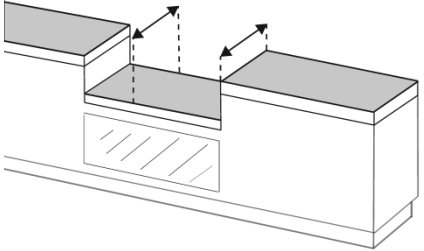
<p>2.76 Is there a portion of at least one of each type of counter that is:</p> <p>No higher than 36 inches above the floor?</p> <p>At least 36 inches long?</p>	<p><input type="checkbox"/> Yes <input checked="" type="checkbox"/> No</p> <p>Measurement: 40"</p> <p><input checked="" type="checkbox"/> Yes <input type="checkbox"/> No</p> <p>Measurement:</p>		 <p>Photo #002</p>	<ul style="list-style-type: none"> • Lower section of counter
<p>2.77 Does the accessible portion of the counter extend the same depth as the counter top?</p>	<p><input checked="" type="checkbox"/> Yes <input type="checkbox"/> No</p> <p>Measurement:</p>			

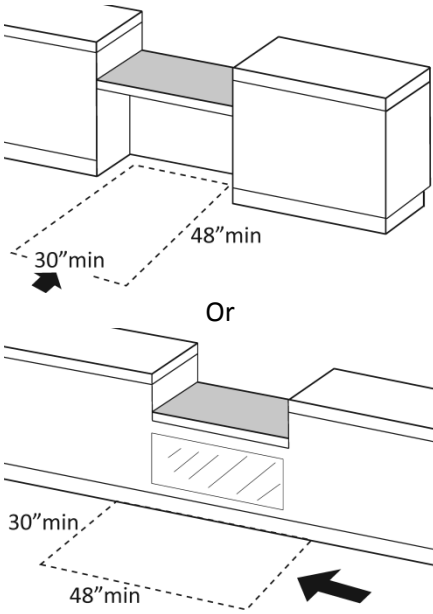
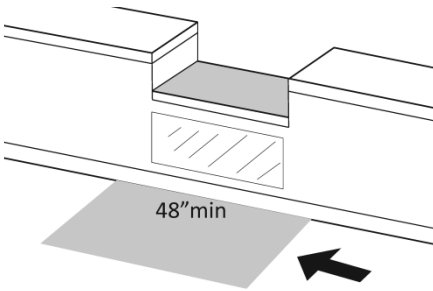
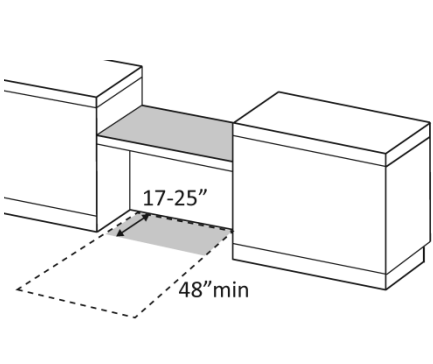
<p>2.78 Is there a clear floor space at least 30 inches wide by at least 48 inches long for a forward or parallel approach?</p>	<p><input checked="" type="checkbox"/> Yes <input type="checkbox"/> No</p> <p><input type="checkbox"/> Parallel Measurement:</p> <p><input type="checkbox"/> Forward Measurement:</p>			
<p>2.79 For a parallel approach, is the clear floor space positioned with the 48 inches adjacent to the accessible length of counter?</p>	<p><input checked="" type="checkbox"/> Yes <input type="checkbox"/> No</p> <p>Measurement:</p>			
<p>2.80 For a forward approach:</p> <p>Do no less than 17 and no greater than 25 inches of the clear floor space extend under the accessible length of the counter?</p> <p>Is there at least 27 inches clearance from the floor to the</p>	<p><input type="checkbox"/> Yes <input checked="" type="checkbox"/> No</p> <p>Measurement:</p> <p><input checked="" type="checkbox"/> Yes <input type="checkbox"/> No</p>			<ul style="list-style-type: none"> • Reconfigure to provide knee clearance

bottom of the counter?	Measurement:			
Kitchens and Kitchenettes (2010 Standards –804)				
2.89 If a pass through kitchen is provided, is 40" clear provided between cabinets?	<input checked="" type="checkbox"/> Yes <input type="checkbox"/> No Measurement:			
2.91 Is work surface no greater than 34" AFF?	<input checked="" type="checkbox"/> Yes <input type="checkbox"/> No Measurement:			
2.92 Does sink comply with the requirement of items 3.21-3.27?	<input type="checkbox"/> Yes <input checked="" type="checkbox"/> No Measurement:		 <p>Photo #003</p>	<ul style="list-style-type: none"> • Replace sink or provide ADA sink

<p>2.93 Does at least 50% of shelf space comply with item 2.xxx?</p>	<p><input checked="" type="checkbox"/> Yes <input type="checkbox"/> No</p> <p>Measurement:</p>			
<p>2.94 Is a 30"x42" clear space provided in front of each appliance?</p>	<p><input checked="" type="checkbox"/> Yes <input type="checkbox"/> No</p> <p>Measurement:</p>			
<p>2.95 Do appliance controls comply with reach requirements?</p>	<p><input checked="" type="checkbox"/> Yes <input type="checkbox"/> No</p>	<p>(a)</p> <p>(b)</p>		

<p>2.96 Does the opened dishwasher door obstruct required clear floor space?</p>	<p><input type="checkbox"/> Yes <input checked="" type="checkbox"/> No</p>			
<p>2.97 Does the location of controls require reaching across burners?</p>	<p><input type="checkbox"/> Yes <input checked="" type="checkbox"/> No</p>			
<p>2.98 If oven is provided, is work surface provided on one of either side if hinged on bottom?...on latch side if side hinged?</p>	<p><input type="checkbox"/> Yes <input checked="" type="checkbox"/> No</p>			
<p>2.99 In a combination freezer/refrigerator, is 50% of freezer space provided at 54" AFF max?</p>	<p><input checked="" type="checkbox"/> Yes <input type="checkbox"/> No</p>			
<p>2.100 Is 30"x48" clear space provided parallel to refrigerator?</p>	<p><input checked="" type="checkbox"/> Yes <input type="checkbox"/> No</p>			

The ADA Checklist for Readily Achievable Barrier Removal

Priority 3 - Toilet Rooms

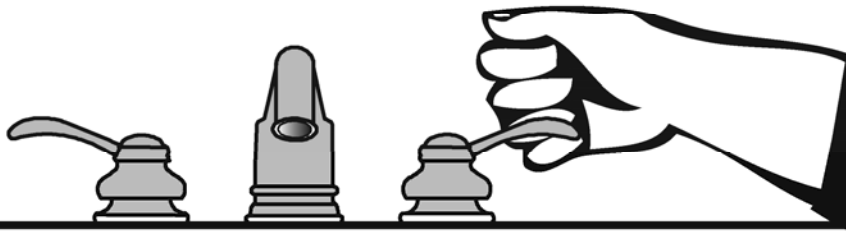

Project

Building

Location

Date

Surveyors

Contact Information

When toilet rooms are open to the public they should be accessible to people with disabilities.



Institute for Human Centered Design
www.HumanCenteredDesign.org
November 2011





ADA National Network
Questions on the ADA 800-949-4232 voice/tty
www.ADAchecklist.org

This checklist was produced by the New England ADA Center, a project of the Institute for Human Centered Design and a member of the ADA National Network. This checklist was developed under a grant from the Department of Education, NIDRR grant number H133A060092-09A. However the contents do not necessarily represent the policy of the Department of Education, and you should not assume endorsement by the Federal Government.

Questions or comments on the checklist contact the New England ADA Center at 617-695-0085 voice/tty or ADAinfo@NewEnglandADA.org

For the full set of checklists, including the checklists for recreation facilities visit www.ADAchecklist.org.

Priority 3 – Toilet Rooms			Comments	Possible Solutions
3.1	If toilet rooms are available to the public, is at least one toilet room accessible? (Either one for each sex, or one unisex.)	<input checked="" type="checkbox"/> Yes <input type="checkbox"/> No		
3.2	Are there signs at inaccessible toilet rooms that give directions to accessible toilet rooms?	<input type="checkbox"/> Yes <input checked="" type="checkbox"/> No		<ul style="list-style-type: none"> • Install signs
3.3	If not all toilet rooms are accessible, is there a sign at the accessible toilet room with the International Symbol of Accessibility?	<input type="checkbox"/> Yes <input checked="" type="checkbox"/> No		<ul style="list-style-type: none"> • Install sign
Accessible Route (2010 Standards – Chapter 4)				
3.4	Is there a route to the accessible toilet room(s) that does not include the use of stairs?	<input checked="" type="checkbox"/> Yes <input type="checkbox"/> No		<ul style="list-style-type: none"> • Widen corridor
	Is the route accessible? (See Priority 2 Interior Accessible Route for specifics.)	<input type="checkbox"/> Yes <input checked="" type="checkbox"/> No		

Signs at Toilet Rooms (2010 Standards – 703)

3.5 Do text characters contrast with their backgrounds?

Yes No

Are text characters raised?

Yes No

Is there Braille?

Yes No

Is the sign mounted:
On the wall on the latch side of the door?

Yes No

Note:

Signs are permitted on the push side of doors with closers and without hold-open devices.

With clear floor space beyond the arc of the door swing between the closed position and 45-degree open position, at least 18 x 18 inches centered on the tactile characters? *

Yes No

Measurement:

So the baseline of the lowest character is at least 48 inches above the floor and the baseline of the highest character is no more than 60 inches above the floor? *

Yes No

Measurement:

Note:

If the sign is at double doors with one active leaf, the sign should be on the inactive leaf; if both leaves are active, the sign

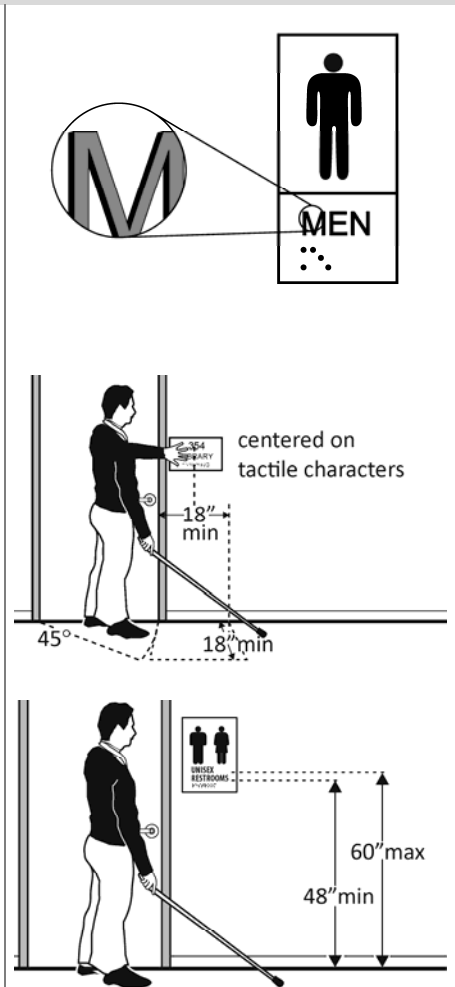

- Install tactile sign

should be on the wall to the right of the right leaf.

Entrance (2010 Standards – 404)

3.6 Is the door opening width at least 32 inches clear, between the face of the door and the stop, when the door is open 90 degrees?

Yes No

Measurement:

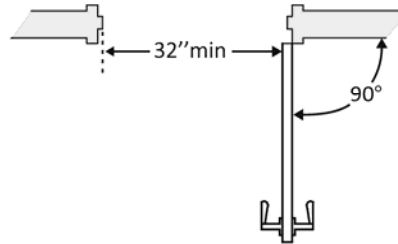

3.7 If there is a front approach to the pull side of the door is there at least 18 inches of maneuvering clearance beyond the latch side plus 60 inches clear depth?

Yes No

Measurement:

On both sides of the door, is the floor surface of the maneuvering clearance level (no steeper than 1:48)?

Yes No

Measurement:

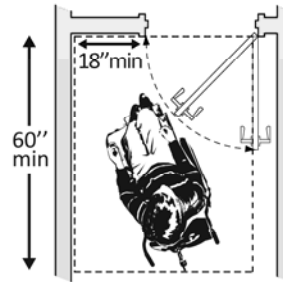

3.8 Is the door threshold edge no more than ¼ inch high?

Yes No

Measurement:

Or



No more than ¾ inch high if slope is beveled no steeper than 1:2?

Yes No

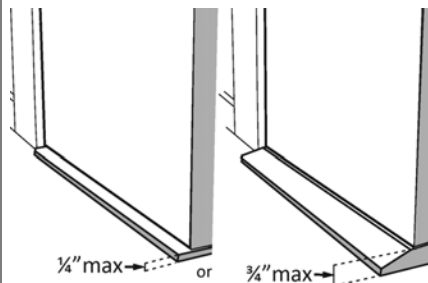
Measurement:

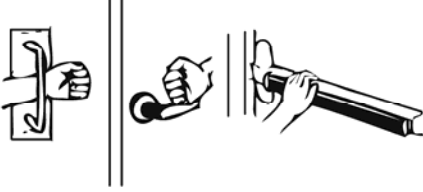
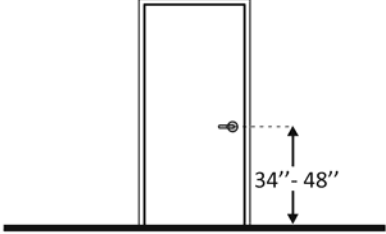

Note: The first ¼ inch of the threshold may be vertical; the rest must be beveled.

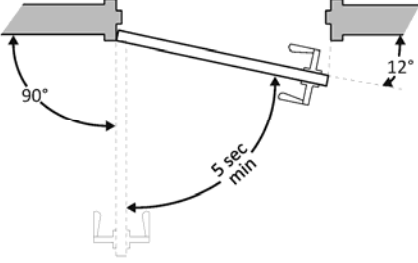

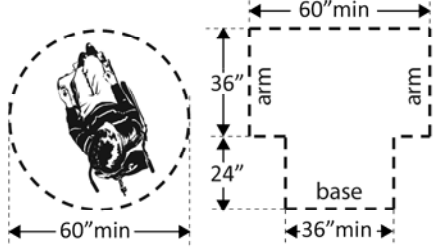
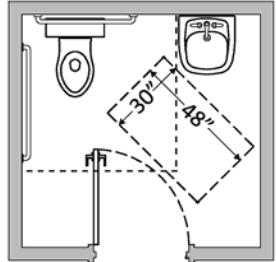
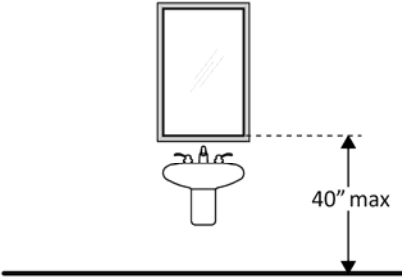
<p>3.9 Is the door equipped with hardware that is operable with one hand and does not require tight grasping, pinching, or twisting of the wrist? Check door handle and lock (if provided).</p>	<p><input checked="" type="checkbox"/> Yes <input type="checkbox"/> No Measurement:</p>			
<p>3.10 Are the operable parts of the door hardware mounted no less than 34 inches and no greater than 48 inches above the floor?</p>	<p><input checked="" type="checkbox"/> Yes <input type="checkbox"/> No Measurement:</p>			
<p>3.11 Can the door be opened easily (5 pounds maximum force)?</p>	<p><input checked="" type="checkbox"/> Yes <input type="checkbox"/> No Measurement:</p>			
<p>3.12 If the door has a closer, does it take at least 5 seconds to close from an open position of 90 degrees to a position of 12 degrees from the latch?</p>	<p><input checked="" type="checkbox"/> Yes <input type="checkbox"/> No Measurement:</p>			

In the Toilet Room				
<p>3.16 Is there a clear path to at least one of each type of fixture, e.g. lavatory, hand dryer, etc., that is at least 36 inches wide?</p>	<p><input checked="" type="checkbox"/> Yes <input type="checkbox"/> No</p> <p>Measurement:</p>			
<p>3.17 Is there clear floor space available for a person in a wheelchair to turn around, i.e. a circle at least 60 inches in diameter or a T-shaped space within a 60-inch square?*</p>	<p><input checked="" type="checkbox"/> Yes <input type="checkbox"/> No</p> <p>Measurement:</p>			
<p>3.18 In a single user toilet room if the door swings in and over a clear floor space at an accessible fixture, is there a clear floor space at least 30 x 48 inches beyond the swing of the door?</p>	<p><input checked="" type="checkbox"/> Yes <input type="checkbox"/> No</p> <p>Measurement:</p>			
<p>3.19 If the mirror is over a lavatory or countertop, is the bottom edge of the reflecting surface no higher than 40 inches above the floor? Or If the mirror is not over the lavatory or countertop, is the bottom edge of the reflecting</p>	<p><input checked="" type="checkbox"/> Yes <input type="checkbox"/> No</p> <p>Measurement:</p> <p><input type="checkbox"/> Yes <input type="checkbox"/> No</p> <p>Measurement:</p>			

<p>surface no higher than 35 inches above the floor?*</p>				
-----------------------------------------------------------	--	--	--	--

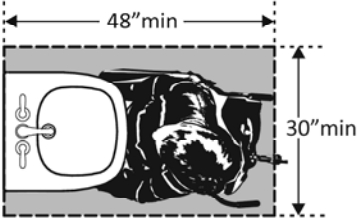
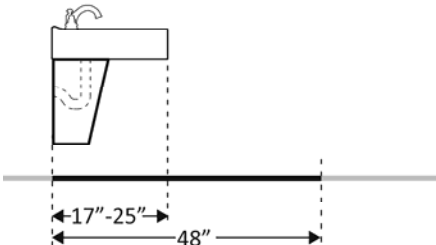
Lavatories (2010 Standards – 606) **Note: 2010 Standards refer to sinks in toilet rooms as lavatories.**

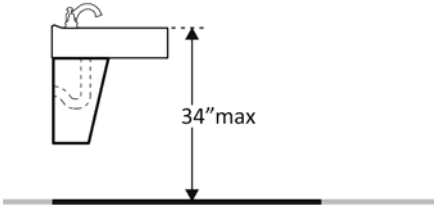
<p>3.21 Does at least one lavatory have a clear floor space for a forward approach at least 30 inches wide and 48 inches long?</p>	<p><input checked="" type="checkbox"/> Yes <input type="checkbox"/> No Measurement:</p>	 <p>The diagram shows a top-down view of a toilet stall. A dashed rectangular box indicates a clear floor space that is 48 inches wide and 30 inches deep. The toilet fixture is shown within this space, positioned towards the back wall.</p>		
<p>3.22 Do no less than 17 inches and no greater than 25 inches of the clear floor space extend under the lavatory so that a person using a wheelchair can get close enough to reach the faucet?</p>	<p><input checked="" type="checkbox"/> Yes <input type="checkbox"/> No Measurement:</p>	 <p>The diagram shows a side view of a lavatory. A dashed rectangular box indicates a clear floor space that is 17 to 25 inches wide and extends under the sink. The total width of the clear floor space is 48 inches.</p>		

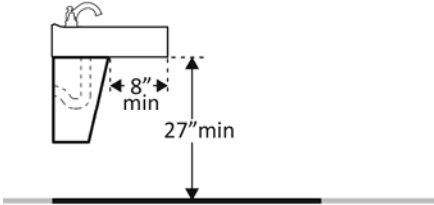
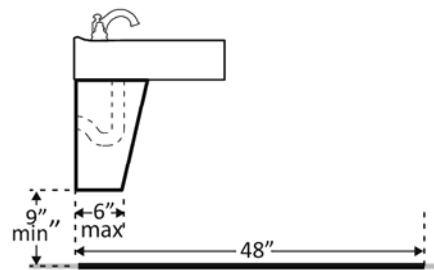
<p>3.23 Is the front of the lavatory or counter surface, whichever is higher, no more than 34 inches above the floor?</p>	<p><input type="checkbox"/> Yes <input checked="" type="checkbox"/> No</p> <p>Measurement: 34-1/2"</p>		 <p>Photo #004</p>	<ul style="list-style-type: none"> • Lower lavatory
<p>3.24 Is there at least 27 inches clearance from the floor to the bottom of the lavatory that extends at least 8 inches under the lav for knee clearance?</p>	<p><input checked="" type="checkbox"/> Yes <input type="checkbox"/> No</p> <p>Measurement:</p>			
<p>3.25 Is there toe clearance at least 9 inches high?</p> <p>(Space extending greater than 6 inches beyond the available toe clearance at 9 inches above the floor is not considered toe clearance.)</p>	<p><input checked="" type="checkbox"/> Yes <input type="checkbox"/> No</p>			

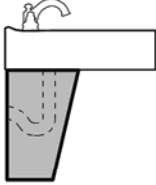
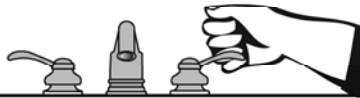
<p>3.26 Are pipes below the lavatory insulated or otherwise configured to protect against contact?</p>	<p><input checked="" type="checkbox"/> Yes <input type="checkbox"/> No</p>			
<p>3.27 Can the faucet be operated without tight grasping, pinching, or twisting of the wrist?</p> <p>Is the force required to activate the faucet no greater than 5 pounds?</p>	<p><input checked="" type="checkbox"/> Yes <input type="checkbox"/> No</p> <p><input checked="" type="checkbox"/> Yes <input type="checkbox"/> No</p>			

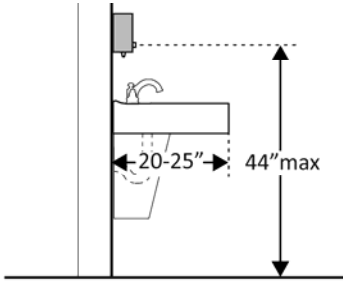

Soap Dispensers and Hand Dryers (2010 Standards – 603)

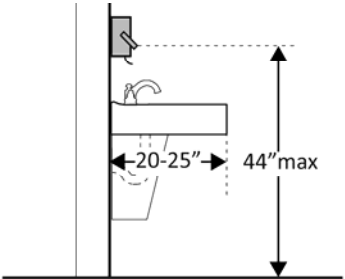
<p>3.28 Are the operable parts of the soap dispenser within one of the following reach ranges:</p> <p>Above lavatories or counters no less than 20 inches and no greater than 25 inches deep: no higher than 44 inches above the floor?</p> <p>Above lavatories less than 20 inches deep: no higher than 48 inches above the floor?</p> <p>Not over an obstruction: no higher than 48 inches above the</p>	<p><input checked="" type="checkbox"/> Yes <input type="checkbox"/> No Measurement:</p> <p><input type="checkbox"/> Yes <input type="checkbox"/> No Measurement:</p> <p><input type="checkbox"/> Yes <input type="checkbox"/> No Measurement:</p>			
-------------------------------------------------------------------------------------------------------------------------------------------------------------------------------------------------------------------------------------------------------------------------------------------------------------------------------------------------------------------------------------------------------------------	---------------------------------------------------------------------------------------------------------------------------------------------------------------------------------------------------------------------------------------------------------------	-------------------------------------------------------------------------------------	--	--

<p>floor?</p>				
<p>3.29 Are the operable parts of the hand dryer or towel dispenser within one of the following reach ranges:</p> <p>Above lavatories or counters no less than 20 inches and no greater than 25 inches deep: no higher than 44 inches above the floor?</p> <p>Above lavatories less than 20 inches deep: no higher than 48 inches above the floor?</p> <p>Not over an obstruction: no higher than 48 inches above the floor?</p> <p>Can the operable parts of the hand dryer or towel dispenser be operated without tight grasping, pinching or twisting of the wrist?</p> <p>Is the force required to activate the hand dryer or towel dispenser no greater than 5</p>	<p><input type="checkbox"/> Yes <input type="checkbox"/> No Measurement:</p> <p><input type="checkbox"/> Yes <input type="checkbox"/> No Measurement:</p> <p><input checked="" type="checkbox"/> Yes <input type="checkbox"/> No Measurement:</p> <p><input checked="" type="checkbox"/> Yes <input type="checkbox"/> No Measurement:</p> <p><input checked="" type="checkbox"/> Yes <input type="checkbox"/> No Measurement:</p>			

pounds?				
---------	--	--	--	--

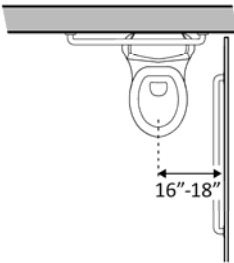
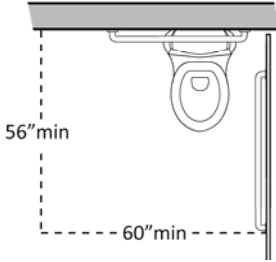
Water Closets in Single-User Toilet Rooms and Compartments (Stalls) (2010 Standards – 603 & 609) Note: 2010 Standards refer to toilets as water closets.

<p>3.30 Is the centerline of the water closet no less than 16 inches and no greater than 18 inches from the side wall or partition?</p>	<p><input checked="" type="checkbox"/> Yes <input type="checkbox"/> No</p> <p>Measurement:</p>			
<p>3.31 Is clearance provided around the water closet measuring at least 60 inches from the side wall and at least 56 inches from the rear wall?*</p>	<p><input type="checkbox"/> Yes <input checked="" type="checkbox"/> No</p> <p>Measurement:</p>		 <p>Photo #005</p>	<ul style="list-style-type: none"> • Reconfigure room

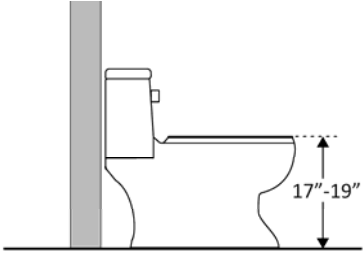
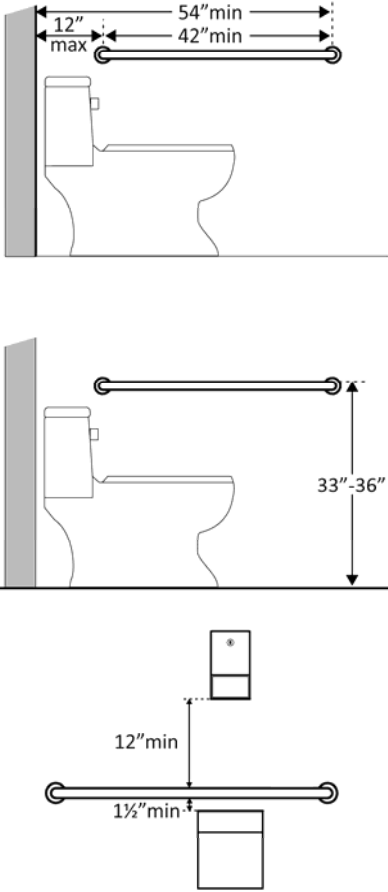
<p>3.32 Is the height of the water closet no less than 17 inches and no greater than 19 inches above the floor measured to the top of the seat?</p>	<p><input checked="" type="checkbox"/> Yes <input type="checkbox"/> No</p> <p>Measurement:</p>		
<p>3.33 Is there a grab bar at least 42 inches long on the side wall?</p> <p>Is it located no more than 12 inches from the rear wall?</p> <p>Does it extend at least 54 inches from the rear wall?</p> <p>Is it mounted no less than 33 inches and no greater than 36 inches above the floor to the top of the gripping surface?</p> <p>Is there at least 12 inches clearance between the grab bar and protruding objects above?*</p> <p>Is there at least 1½ inches clearance between the grab bar and projecting objects below?*</p> <p>Is the space between the wall and the grab bar 1 ½ inches?</p>	<p><input type="checkbox"/> Yes <input checked="" type="checkbox"/> No</p> <p>Measurement: 36"</p> <p><input type="checkbox"/> Yes <input type="checkbox"/> No</p> <p>Measurement:</p> <p><input type="checkbox"/> Yes <input checked="" type="checkbox"/> No</p> <p>Measurement:</p> <p><input checked="" type="checkbox"/> Yes <input type="checkbox"/> No</p> <p>Measurement:</p> <p><input checked="" type="checkbox"/> Yes <input type="checkbox"/> No</p> <p>Measurement:</p> <p><input checked="" type="checkbox"/> Yes <input type="checkbox"/> No</p> <p>Measurement:</p>		<ul style="list-style-type: none"> • Replace grab bar

<p>3.34 Is there a grab bar at least 36 inches long on the rear wall?</p> <p>Does it extend at least 12 inches from the centerline of the water closet on one side (side wall)?</p> <p>Does it extend at least 24 inches on the other (open) side?</p> <p>Is it mounted no less than 33 inches and no greater than 36 inches above the floor to the top of the gripping surface?</p> <p>Are there at least 12 inches clearance between the grab bar and protruding objects above?*</p> <p>Are there at least 1½ inches clearance between the grab bar and projecting objects below?*</p> <p>Is the space between the wall and the grab bar 1 ½ inches?</p>	<p><input checked="" type="checkbox"/> Yes <input type="checkbox"/> No</p> <p>Measurement:</p> <p><input checked="" type="checkbox"/> Yes <input type="checkbox"/> No</p> <p>Measurement:</p> <p><input checked="" type="checkbox"/> Yes <input type="checkbox"/> No</p> <p>Measurement:</p> <p><input checked="" type="checkbox"/> Yes <input type="checkbox"/> No</p> <p>Measurement:</p> <p><input checked="" type="checkbox"/> Yes <input type="checkbox"/> No</p> <p>Measurement:</p> <p><input checked="" type="checkbox"/> Yes <input type="checkbox"/> No</p> <p>Measurement:</p>			
-------------------------------------------------------------------------------------------------------------------------------------------------------------------------------------------------------------------------------------------------------------------------------------------------------------------------------------------------------------------------------------------------------------------------------------------------------------------------------------------------------------------------------------------------------------------------------------------------------------------------------------------------------------------	-------------------------------------------------------------------------------------------------------------------------------------------------------------------------------------------------------------------------------------------------------------------------------------------------------------------------------------------------------------------------------------------------------------------------------------------------------------------------------------------------------------------------------------------------------------------------------------------	--	--	--

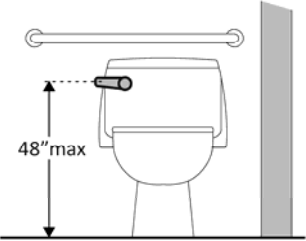
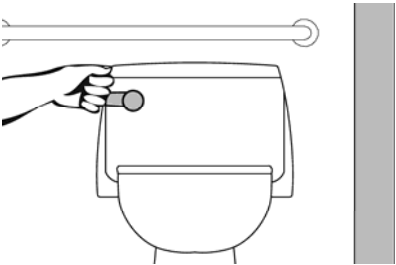
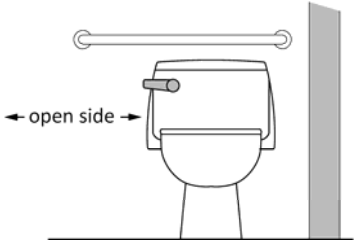
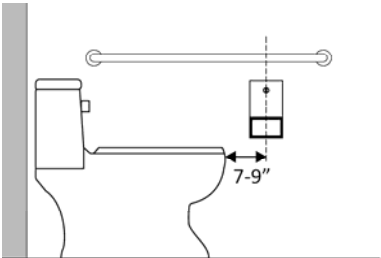
<p>3.35 If the flush control is hand operated, is the operable part located no higher than 48 inches above the floor?</p>	<p><input checked="" type="checkbox"/> Yes <input type="checkbox"/> No</p> <p>Measurement:</p>			
<p>3.36 If the flush control is hand operated, can it be operated with one hand and without tight grasping, pinching, or twisting of the wrist?</p> <p>Is the force required to activate the flush control no greater than 5 pounds?</p>	<p><input checked="" type="checkbox"/> Yes <input type="checkbox"/> No</p> <p><input checked="" type="checkbox"/> Yes <input type="checkbox"/> No</p> <p>Measurement:</p>			
<p>3.37 Is the flush control on the open side of the water closet?</p>	<p><input checked="" type="checkbox"/> Yes <input type="checkbox"/> No</p>			
<p>3.38 Is the toilet paper dispenser located no less than 7 inches and no greater than 9 inches from the front of the water closet to the centerline of the dispenser?*</p>	<p><input checked="" type="checkbox"/> Yes <input type="checkbox"/> No</p> <p>Measurement:</p>			

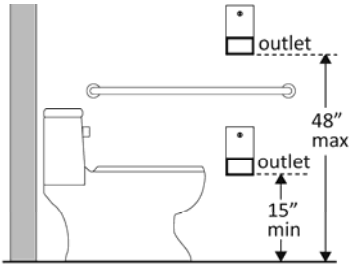
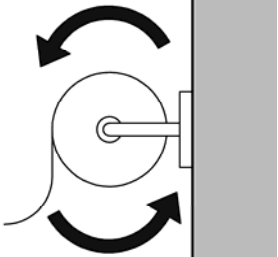
<p>3.39 Is the outlet of the dispenser:</p> <p>Located no less than 15 inches and no greater than 48 inches above the floor?</p> <p>Not located behind grab bars?</p>	<p><input checked="" type="checkbox"/> Yes <input type="checkbox"/> No</p> <p>Measurement:</p> <p><input checked="" type="checkbox"/> Yes <input type="checkbox"/> No</p>			
<p>3.40 Does the dispenser allow continuous paper flow?</p>	<p><input checked="" type="checkbox"/> Yes <input type="checkbox"/> No</p>			

ADA Checklist for Readily Achievable Barrier Removal

Priority 4 – Additional Access

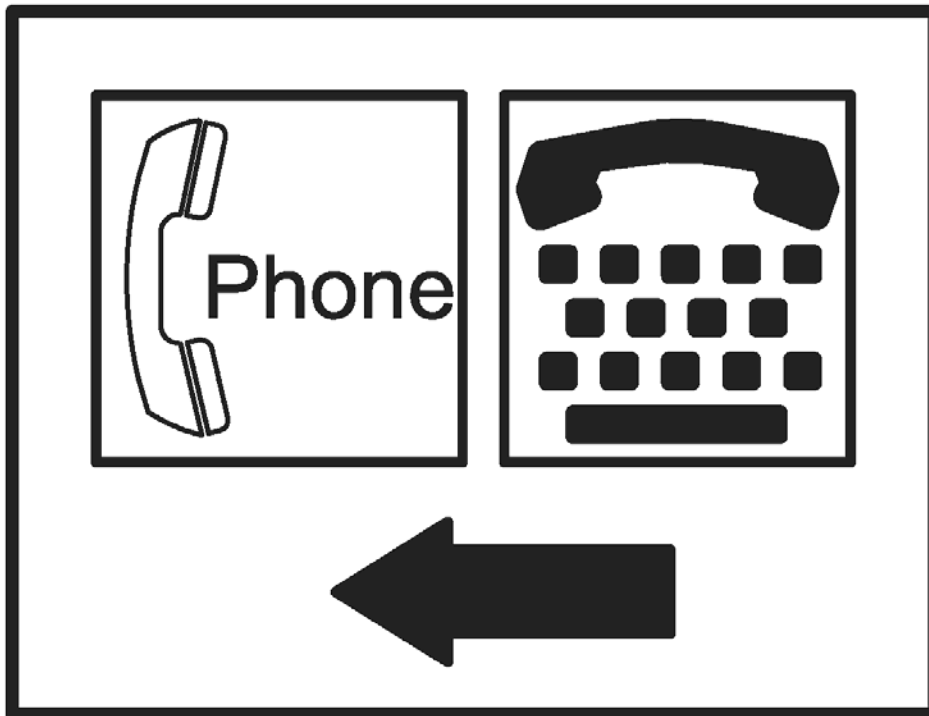

Project

Building

Location

Date

Surveyors

Contact Information

Amenities such as drinking fountains and public telephones should be accessible to people with disabilities.



Institute for Human Centered Design
www.HumanCenteredDesign.org
November 2011







ADA National Network
Questions on the ADA 800-949-4232 voice/tty
www.ADAchecklist.org

This checklist was produced by the New England ADA Center, a project of the Institute for Human Centered Design and a member of the ADA National Network. This checklist was developed under a grant from the Department of Education, NIDRR grant number H133A060092-09A. However the contents do not necessarily represent the policy of the Department of Education, and you should not assume endorsement by the Federal Government.

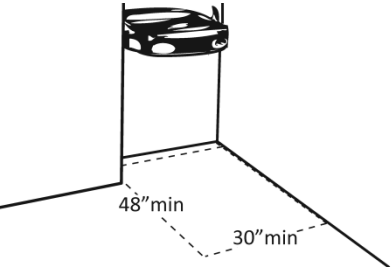
Questions or comments on the checklist contact the New England ADA Center at 617-695-0085 voice/tty or ADAinfo@NewEnglandADA.org

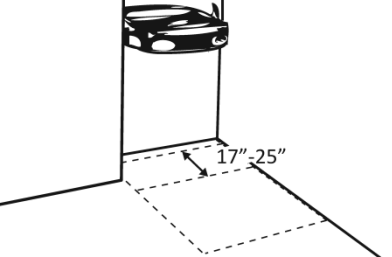
For the full set of checklists, including the checklists for recreation facilities visit www.ADAchecklist.org.

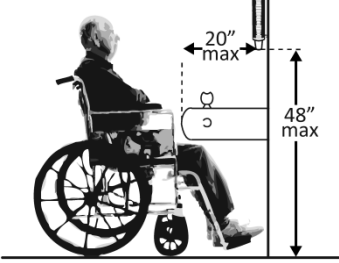
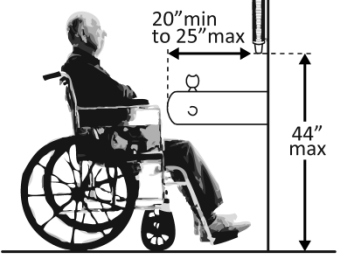
Priority 4 – Additional Access		Comments	Possible Solutions	
Drinking Fountains (2010 Standards – 602)				
<p>4.1 Does at least one drinking fountain have a clear floor space at least 30 inches wide x at least 48 inches long centered in front of it for a forward approach?*</p>	<p><input type="checkbox"/> Yes <input checked="" type="checkbox"/> No</p>	<p>Measurement:</p> 	 <p>Photo #006</p>	<ul style="list-style-type: none"> • Replace drinking fountain
<p>4.2 If there is a forward approach, do no less than 17 inches and no greater than 25 inches of the clear floor space extend under the drinking fountain?</p>	<p><input type="checkbox"/> Yes <input checked="" type="checkbox"/> No</p>	<p>Measurement:</p> 		

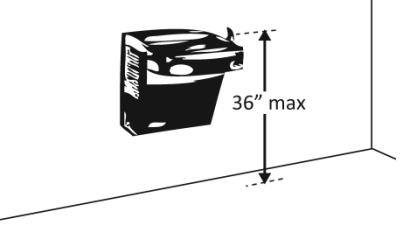
<p>4.3 If the drinking fountain is no deeper than 20 inches, are the operable parts no higher than 48 inches above the floor?</p>	<p><input type="checkbox"/> Yes <input checked="" type="checkbox"/> No</p> <p>Measurement:</p>			
<p>4.4 If the drinking fountain is no less than 20 inches and no greater than 25 inches deep, are the operable parts no higher than 44 inches above the floor?</p>	<p><input type="checkbox"/> Yes <input checked="" type="checkbox"/> No</p> <p>Measurement:</p>			
<p>4.5 Can the control be operated with one hand and without tight grasping, pinching or twisting of the wrist?</p> <p>Is the force required to activate the control no more than 5 pounds?</p>	<p><input type="checkbox"/> Yes <input checked="" type="checkbox"/> No</p> <p><input type="checkbox"/> Yes <input checked="" type="checkbox"/> No</p> <p>Measurement:</p>			
<p>4.6 Is the spout outlet no higher than 36 inches above the floor?</p>	<p><input type="checkbox"/> Yes <input checked="" type="checkbox"/> No</p> <p>Measurement:</p>			

<p>4.7 Is the spout:</p> <p>At least 15 inches from the rear of the drinking fountain?</p> <p>No more than 5 inches from the front of the drinking fountain?</p>	<p><input type="checkbox"/> Yes <input checked="" type="checkbox"/> No</p> <p>Measurement:</p> <p><input type="checkbox"/> Yes <input checked="" type="checkbox"/> No</p> <p>Measurement:</p>			
<p>4.8 If there is more than one drinking fountain, is there at least one for standing persons?</p> <p>Is the spout outlet no lower than 38 inches and no higher than 43 inches above the floor?</p>	<p><input type="checkbox"/> Yes <input checked="" type="checkbox"/> No</p> <p><input type="checkbox"/> Yes <input checked="" type="checkbox"/> No</p> <p>Measurement:</p>			
<p>4.9 If the leading (bottom) edge of the fountain is higher than 27 inches above the floor, does the front of the fountain protrude no more than 4 inches into the circulation path?</p>	<p><input type="checkbox"/> Yes <input checked="" type="checkbox"/> No</p> <p>Measurement:</p>			



Photo #001



Photo #002

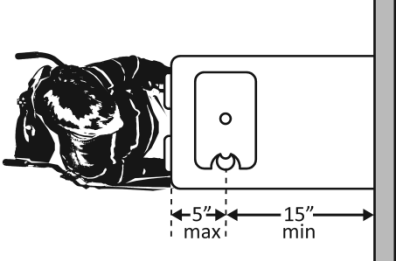
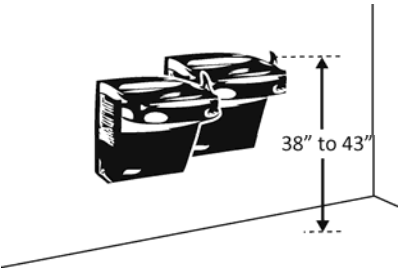
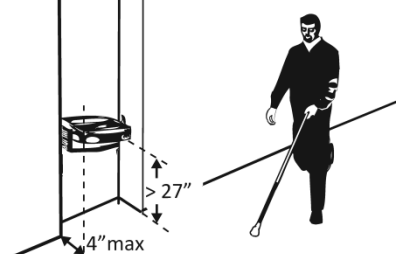

Photo #003



Photo #004

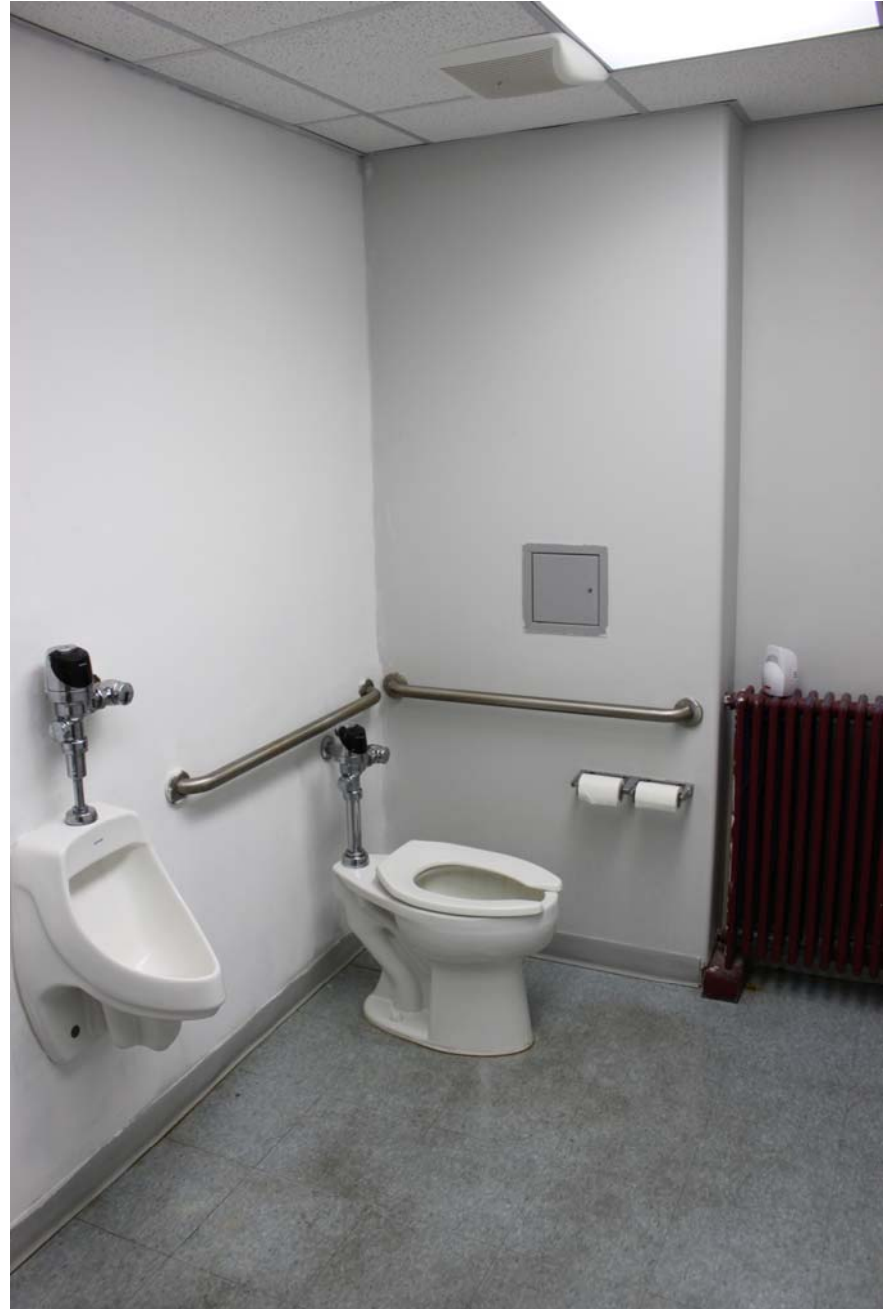
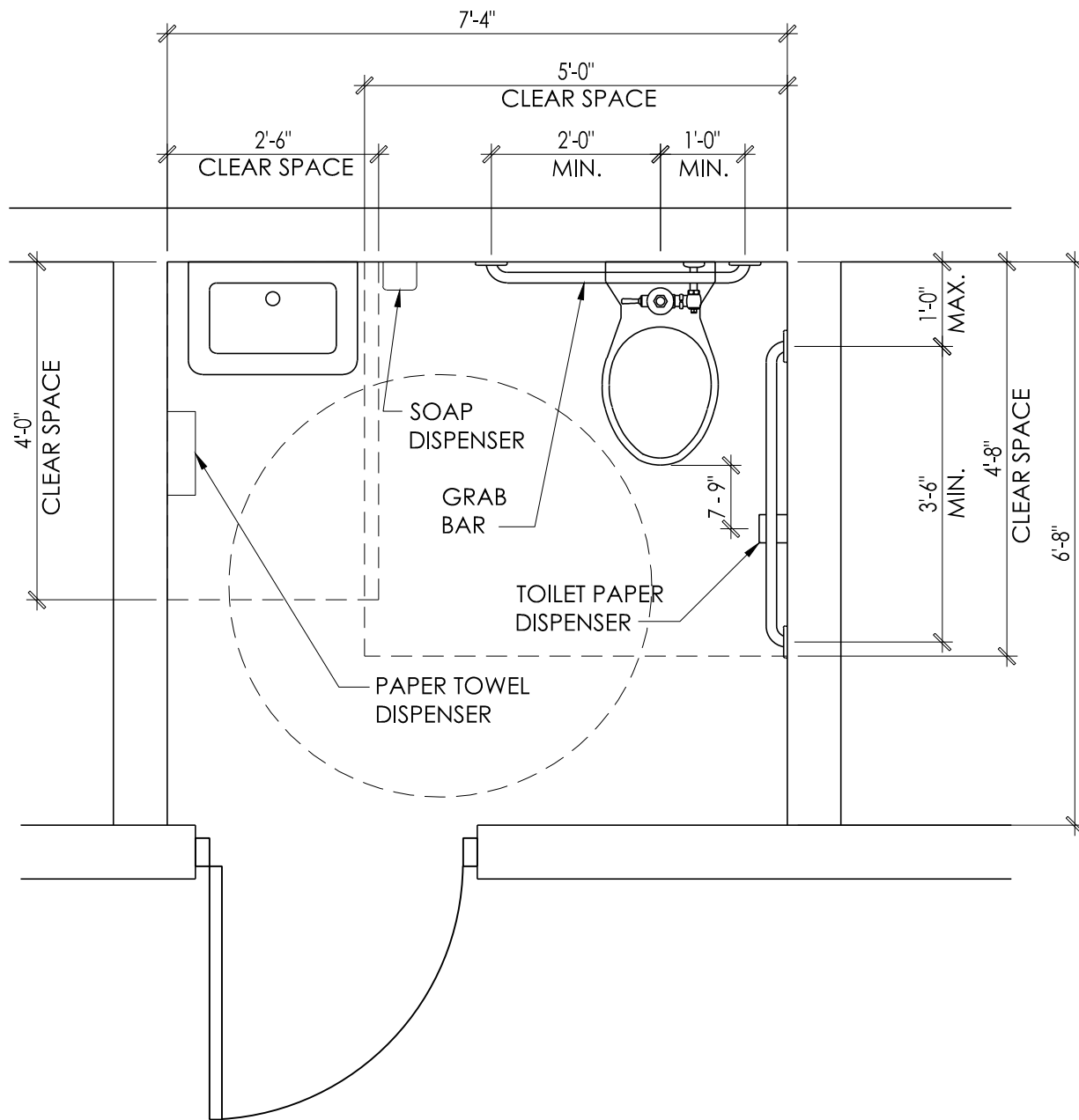

Photo #005



Photo #006



SKETCH #001 - TYPICAL ACCESSIBLE TOILET PLAN

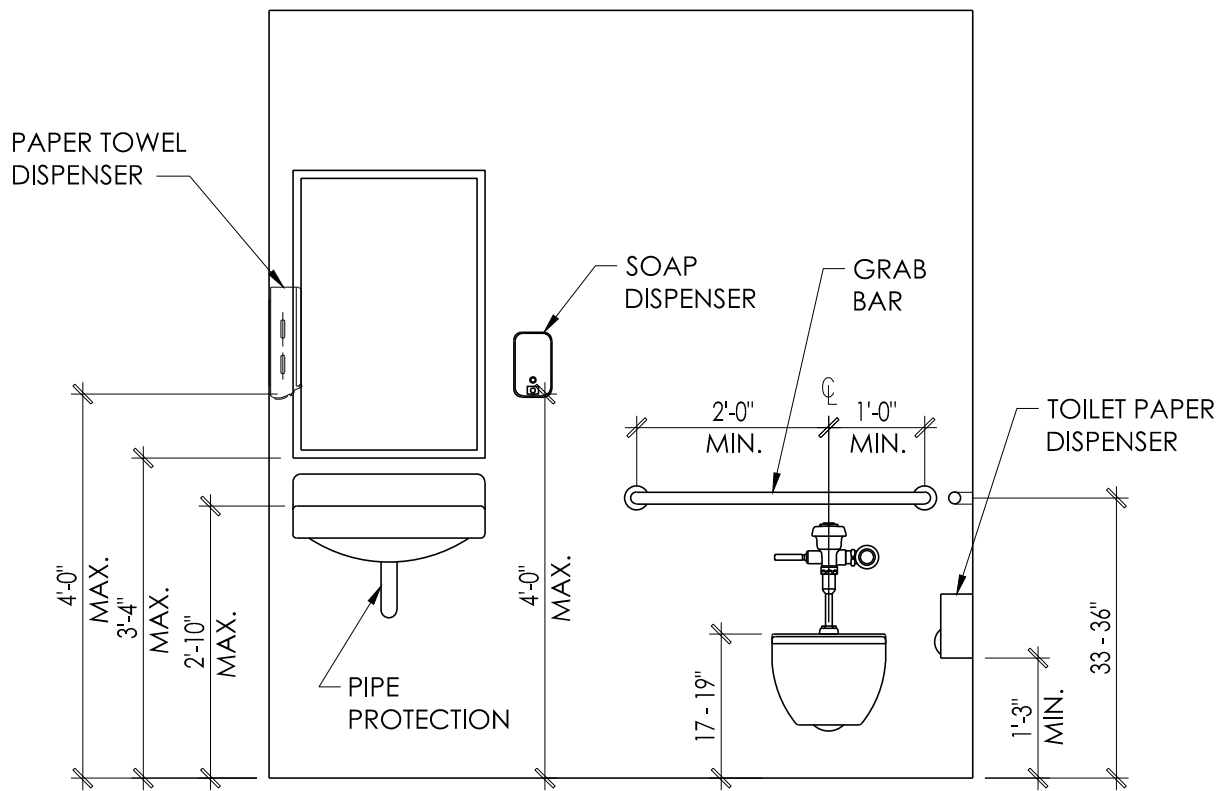

SKETCH #002 - TYPICAL ACCESSIBLE TOILET
 ELEVATION

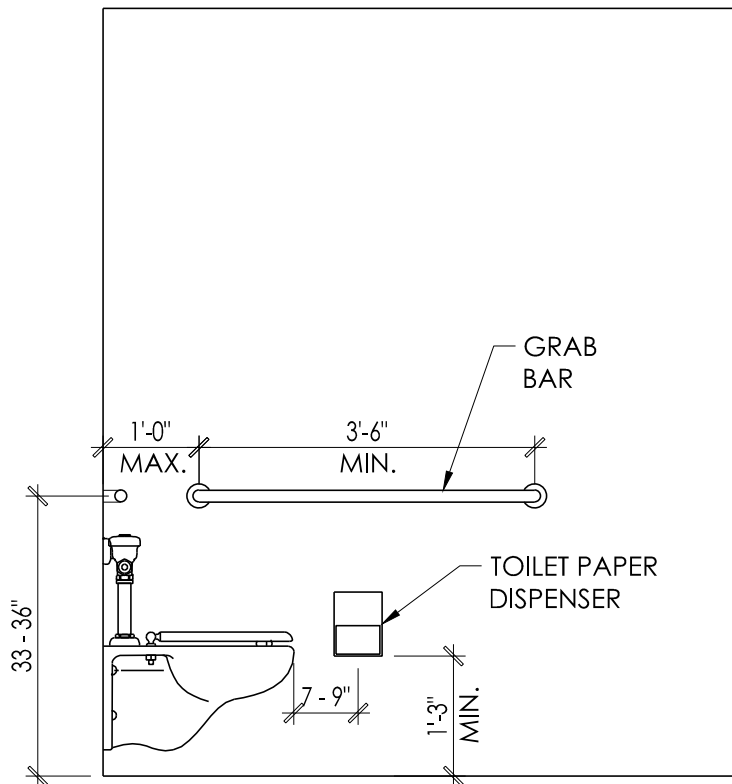

SKETCH #003 - TYPICAL ACCESSIBLE TOILET
ELEVATION

ADA Checklist for Readily Achievable Barrier Removal

Priority 1 – Approach & Entrance



Project Cass County Transition Plan

Building Sheriff Building / Jail

Location Logansport, IN

Date 12-10-2012

Surveyors Henry Stellema & Dustin Schrougham

Contact Information 1-800-321-6959

An accessible route from site arrival points and an accessible entrance should be provided for everyone.



Institute for Human Centered Design
www.HumanCenteredDesign.org

November 2011



ADA National Network
Questions on the ADA 800-949-4232 voice/tty



www.ADAchecklist.org

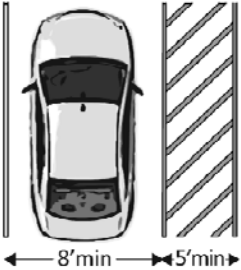

This checklist was produced by the New England ADA Center, a project of the Institute for Human Centered Design and a member of the ADA National Network. This checklist was developed under a grant from the Department of Education, NIDRR grant number H133A060092-09A. However the contents do not necessarily represent the policy of the Department of Education, and you should not assume endorsement by the Federal Government.

Questions or comments on the checklist contact the New England ADA Center at 617-695-0085 voice/tty or ADAinfo@NewEnglandADA.org

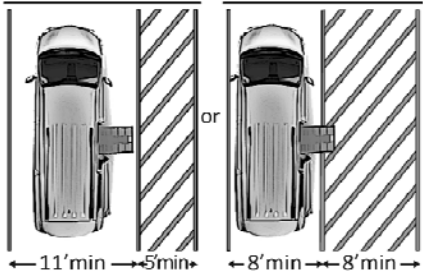

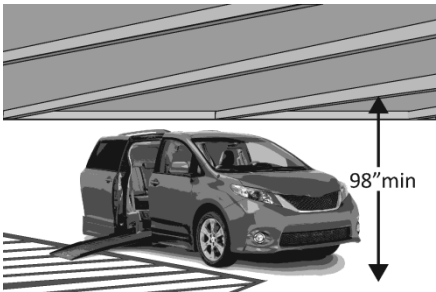
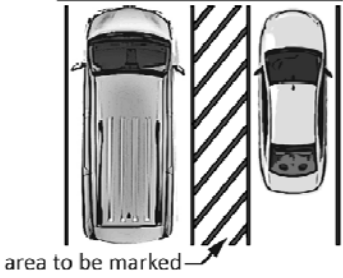
For the full set of checklists, including the checklists for recreation facilities visit www.ADAchecklist.org.

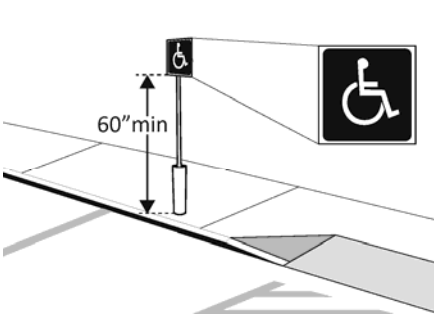
Priority 1 – Approach & Entrance		Comments	Possible Solutions												
<p>1.1 Is there at least one route from site arrival points (parking, passenger loading zones, public sidewalks and public transportation stops) that does not require the use of stairs?</p>	<input checked="" type="checkbox"/> Yes <input type="checkbox"/> No If yes, location of route:														
<p>Parking (2010 Standards – 208 & 502) Note: Accessible parking spaces should be identified by size, access aisle and signage.</p>															
<p>1.2 If parking is provided for the public, are an adequate number of accessible spaces provided?</p>	<input checked="" type="checkbox"/> Yes <input type="checkbox"/> No Total #:73 Accessible #: 3	<table border="1"> <thead> <tr> <th>Total Spaces</th> <th>Accessible Spaces</th> </tr> </thead> <tbody> <tr> <td>1 - 25</td> <td>1</td> </tr> <tr> <td>26 - 50</td> <td>2</td> </tr> <tr> <td>51 - 75</td> <td>3</td> </tr> <tr> <td>76 - 100</td> <td>4</td> </tr> <tr> <td>100+ see 2010 Standards 208.2</td> <td></td> </tr> </tbody> </table>	Total Spaces	Accessible Spaces	1 - 25	1	26 - 50	2	51 - 75	3	76 - 100	4	100+ see 2010 Standards 208.2		
Total Spaces	Accessible Spaces														
1 - 25	1														
26 - 50	2														
51 - 75	3														
76 - 100	4														
100+ see 2010 Standards 208.2															
<p>1.3 Of the accessible spaces, is at least one a van accessible space?*</p>	<input checked="" type="checkbox"/> Yes <input type="checkbox"/> No	<p>*For every 6 or fraction of 6 parking spaces required by the table above, at least 1 should be a van accessible space.</p>													
<p>1.4 Are accessible spaces at least 8 feet wide with an access aisle at least 5 feet wide?</p>	<input checked="" type="checkbox"/> Yes <input type="checkbox"/> No Measurement:	 <p>The diagram shows a top-down view of a car parked in a space. To the right of the car is a shaded area representing an access aisle. Dimension lines indicate a minimum width of 8 feet for the total space and a minimum width of 5 feet for the access aisle.</p>													

<p>1.5 Is the van accessible space:</p> <p>At least 11 feet wide with an access aisle at least 5 feet wide? Or At least 8 feet wide with an access aisle at least 8 feet wide?</p>	<p><input type="checkbox"/> Yes <input checked="" type="checkbox"/> No Measurement:</p> <p><input type="checkbox"/> Yes <input checked="" type="checkbox"/> No Measurement:</p>		 <p>Photo #001</p>	<ul style="list-style-type: none"> Reconfigure to provide van-accessible space(s)
<p>1.6 Is at least 98 inches of vertical clearance provided for the van accessible space?</p>	<p><input checked="" type="checkbox"/> Yes <input type="checkbox"/> No Measurement:</p>			
<p>1.7 Are the access aisles marked so as to discourage parking in them?</p>	<p><input checked="" type="checkbox"/> Yes <input type="checkbox"/> No</p>			
<p>1.8 Is the slope of the accessible parking spaces and access aisles no steeper than 1:48 in all directions?</p>	<p><input checked="" type="checkbox"/> Yes <input type="checkbox"/> No Measurement:</p>			

<p>1.9 Do the access aisles adjoin an accessible route?</p>	<p><input checked="" type="checkbox"/> Yes <input type="checkbox"/> No</p>			
<p>1.10 Are accessible spaces Identified with a sign that includes the International Symbol of Accessibility?</p> <p>Is the bottom of the sign at least 60 inches above the ground?</p>	<p><input checked="" type="checkbox"/> Yes <input type="checkbox"/> No</p> <p><input type="checkbox"/> Yes <input checked="" type="checkbox"/> No</p> <p>Measurement:</p>			<ul style="list-style-type: none"> • Raise signs <p>The International Symbol of Accessibility is not required on the ground by the 2010 Standards</p>
<p>1.11 Are there signs reading “van accessible” at van accessible spaces?</p>	<p><input checked="" type="checkbox"/> Yes <input type="checkbox"/> No</p>			
<p>1.12 Of the total parking spaces, are the accessible spaces located on the closest accessible route to the accessible entrance(s)?</p>	<p><input checked="" type="checkbox"/> Yes <input type="checkbox"/> No</p>			

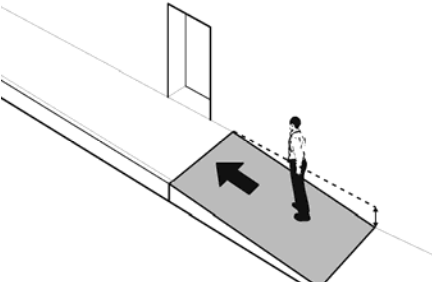
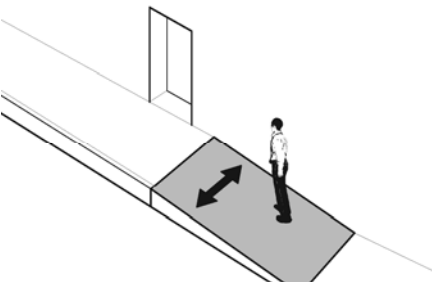
Exterior Accessible Route (2010 Standards – Ch.4)				
<p>1.13 Is the route stable, firm and slip-resistant?</p>	<p><input checked="" type="checkbox"/> Yes <input type="checkbox"/> No</p>			
<p>1.14 Is the route at least 36 inches wide?</p> <p>Note: The accessible route can narrow to 32 inches min. for a max. of 24 inches. These narrower portions of the route must be at least 48 inches from each other.</p>	<p><input checked="" type="checkbox"/> Yes <input type="checkbox"/> No</p> <p>Measurement:</p>	<p>The diagram illustrates two scenarios for wheelchair width. The top scenario shows a wheelchair between two parallel lines with a vertical double-headed arrow indicating a minimum width of 36 inches. The bottom scenario shows a wheelchair between two parallel lines with a vertical double-headed arrow indicating a minimum width of 32 inches. Above this, a horizontal double-headed arrow indicates a maximum width of 24 inches for narrow sections, and another horizontal double-headed arrow indicates a maximum of 48 inches between narrow sections.</p>		
<p>1.15 If the route is greater than 200 feet in length and no less than 60 inches wide, is there a passing space no less than 60 x 60 inches?</p>	<p><input checked="" type="checkbox"/> Yes <input type="checkbox"/> No</p> <p>Measurement:</p>	<p>The diagram shows two wheelchairs in a passing space. A vertical double-headed arrow on the left indicates a minimum height of 36 inches. A horizontal double-headed arrow at the bottom indicates a maximum width of 60 inches. A vertical double-headed arrow on the right indicates a minimum height of 60 inches for the passing space.</p>		

<p>1.17 Is the running slope no steeper than 1:20, i.e. for every inch of height change there are at least 20 inches of route run?</p>	<p><input checked="" type="checkbox"/> Yes <input type="checkbox"/> No</p> <p>Measurement:</p>			
<p>1.18 Is the cross slope no steeper than 1:48?</p>	<p><input checked="" type="checkbox"/> Yes <input type="checkbox"/> No</p> <p>Measurement:</p>			
<p>Entrance (2010 Standards – 404)</p>				
<p>1.37 Is the main entrance accessible?</p>	<p><input checked="" type="checkbox"/> Yes <input type="checkbox"/> No</p>			<ul style="list-style-type: none"> • Redesign to make it accessible
<p>1.39 Do all inaccessible entrances have signs indicating the location of the nearest accessible entrance?</p>	<p><input type="checkbox"/> Yes <input checked="" type="checkbox"/> No</p>			<ul style="list-style-type: none"> • Install signs

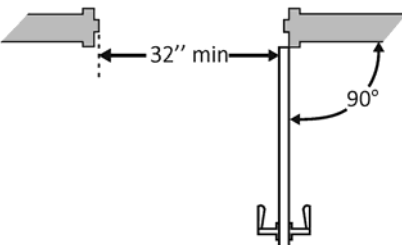
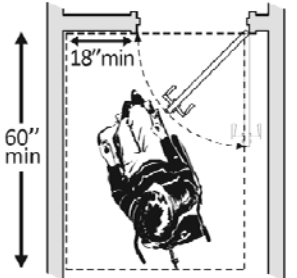
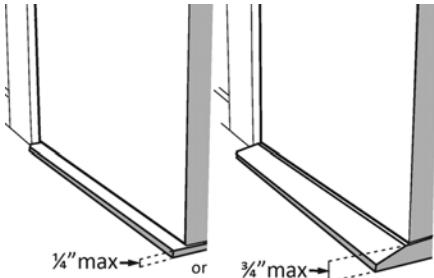
<p>1.40 If not all entrances are accessible, is there a sign at the accessible entrance with the International Symbol of Accessibility?</p>	<p><input type="checkbox"/> Yes <input checked="" type="checkbox"/> No</p>		<ul style="list-style-type: none"> • Install sign
<p>1.41 Is the clear opening width of the accessible entrance door at least 32 inches, between the face of the door and the stop, when the door is open 90 degrees?</p>	<p><input checked="" type="checkbox"/> Yes <input type="checkbox"/> No Measurement:</p>		
<p>1.42 If there is a front approach to the pull side of the door, is there at least 18 inches of maneuvering clearance beyond the latch side plus at least 60 inches clear depth?</p> <p>On both sides of the door, is the ground or floor surface of the maneuvering clearance level (no steeper than 1:48)?</p>	<p><input checked="" type="checkbox"/> Yes <input type="checkbox"/> No Measurement:</p> <p><input checked="" type="checkbox"/> Yes <input type="checkbox"/> No Measurement:</p>		
<p>1.43 Is the door threshold edge no more than ¼ inch high?</p> <p>Or</p> <p>No more than ¾ inch high if slope is beveled no steeper than 1:2?</p>	<p><input checked="" type="checkbox"/> Yes <input type="checkbox"/> No Measurement:</p> <p><input checked="" type="checkbox"/> Yes <input type="checkbox"/> No Measurement:</p>		

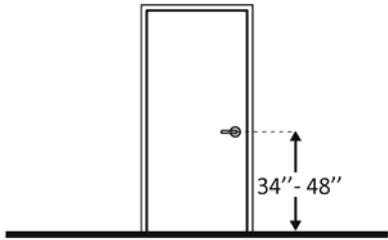
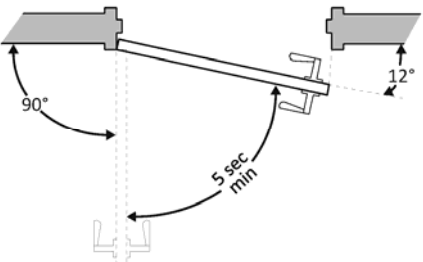
<p>Note: The first ¼ inch of the threshold may be vertical; the rest must be beveled.</p>				
<p>1.44 Is the door equipped with hardware, including locks, that is operable with one hand and does not require tight grasping, pinching, or twisting of the wrist?</p>	<p><input checked="" type="checkbox"/> Yes <input type="checkbox"/> No</p>			
<p>1.45 Are the operable parts of the door hardware no less than 34 inches and no greater than 48 inches above the floor or ground surface?</p>	<p><input checked="" type="checkbox"/> Yes <input type="checkbox"/> No Measurement:</p>			
<p>1.46 If the door has a closer, does it take at least 5 seconds to close from an open position of 90 degrees to a position of 12 degrees from the latch?</p>	<p><input checked="" type="checkbox"/> Yes <input type="checkbox"/> No Measurement:</p>			

<p>1.47 If there are two doors in a series, e.g. vestibule, is the distance between the doors at least 48 inches plus the width of the doors when swinging into the space?</p>	<p><input checked="" type="checkbox"/> Yes <input type="checkbox"/> No</p> <p>Measurement:</p>			
<p>1.48 If provided at the building entrance, are carpets or mats no higher than ½ inch thick?</p>	<p><input checked="" type="checkbox"/> Yes <input type="checkbox"/> No</p> <p>Measurement:</p>			

1.49 Are edges of carpets or mats securely attached to minimize tripping hazards?	<input checked="" type="checkbox"/> Yes <input type="checkbox"/> No			
------------------------------------------------------------------------------------------	---------------------------------------------------------------------	--	--	--

ADA Checklist for Readily Achievable Barrier Removal

Priority 2 – Access to Goods & Services

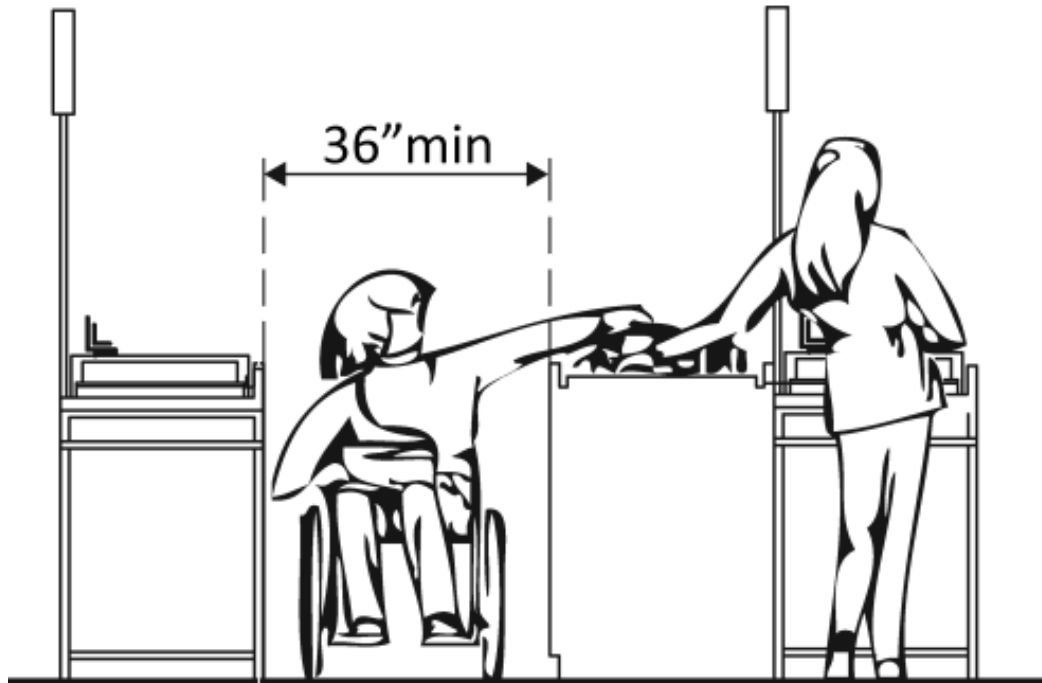

Project _____

Building _____

Location _____

Date _____

Surveyors _____

Contact Information _____

The layout of the building should allow people with disabilities to obtain goods and services and to participate in activities without assistance.



Institute for Human Centered Design
www.HumanCenteredDesign.org
November 2011





ADA National Network
Questions on the ADA 800-949-4232 voice/tty
www.ADAchecklist.org

This checklist was produced by the New England ADA Center, a project of the Institute for Human Centered Design and a member of the ADA National Network. This checklist was developed under a grant from the Department of Education, NIDRR grant number H133A060092-09A. However the contents do not necessarily represent the policy of the Department of Education, and you should not assume endorsement by the Federal Government.

Questions or comments on the checklist contact the New England ADA Center at 617-695-0085 voice/tty or ADAinfo@NewEnglandADA.org

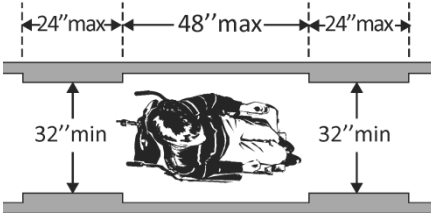
For the full set of checklists, including the checklists for recreation facilities visit www.ADAchecklist.org.

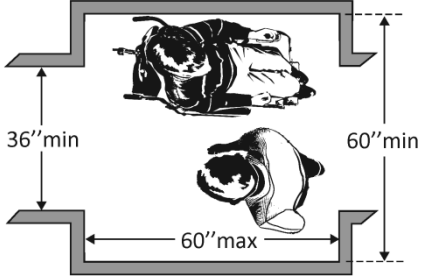
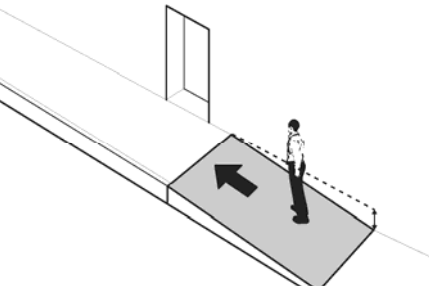
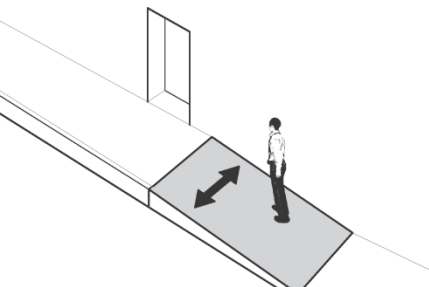
Priority 2 – Access to Goods & Services		Comments	Possible Solutions
<p>2.1 Does the accessible entrance provide direct access to the main floor, lobby and elevator?</p> <p><input checked="" type="checkbox"/> Yes <input type="checkbox"/> No</p>			
<p>Interior Accessible Route (2010 Standards – Ch.4)</p>			
<p>2.2 Are all public spaces on at least one accessible route?</p> <p><input checked="" type="checkbox"/> Yes <input type="checkbox"/> No</p>			
<p>2.3 Is the route stable, firm and slip-resistant?</p> <p><input checked="" type="checkbox"/> Yes <input type="checkbox"/> No</p>			
<p>2.4 Is the route at least 36 inches wide?</p> <p>Note: The accessible route can narrow to 32 inches min. for a max. of 24 inches. These narrower portions of the route must be at least 48 inches from each other.</p> <p>Measurement:</p>	 		

<p>2.5 If the route is greater than 200 feet in length and no less than 36 inches wide, is there a passing space no less than 60 x 60 inches?</p>	<p><input checked="" type="checkbox"/> Yes <input type="checkbox"/> No</p> <p>Measurement:</p>			
<p>2.6 Is the running slope no steeper than 1:20, i.e. for every inch of height change there are at least 20 inches of route run?</p>	<p><input checked="" type="checkbox"/> Yes <input type="checkbox"/> No</p> <p>Measurement:</p>			
<p>2.7 Is the cross slope no steeper than 1:48?</p>	<p><input checked="" type="checkbox"/> Yes <input type="checkbox"/> No</p> <p>Measurement:</p>			
<p>2.8 Do all objects on circulation paths through public areas, e.g. fire extinguishers, drinking fountains, signs, etc., protrude no more than 4 inches into the path? Or If an object protrudes more than 4 inches, is the bottom leading edge at 27 inches or lower above the floor?</p>	<p><input checked="" type="checkbox"/> Yes <input type="checkbox"/> No</p> <p>Measurement:</p> <p><input type="checkbox"/> Yes <input type="checkbox"/> No</p> <p>Measurement:</p>	 <p style="text-align: center;">Or</p>		

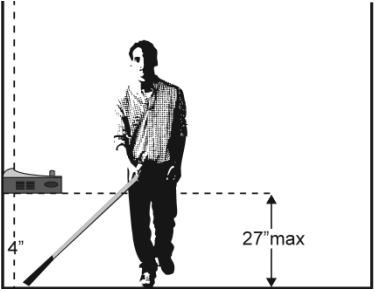
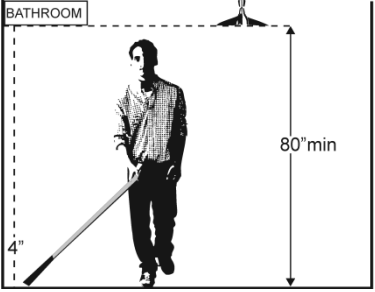
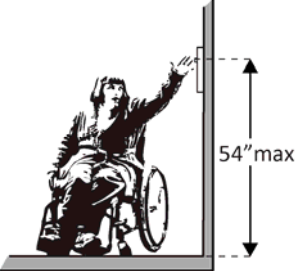
<p>Or Is the bottom leading edge at 80 inches or higher above the floor?</p>	<p><input type="checkbox"/> Yes <input type="checkbox"/> No Measurement:</p>	 <p>Or</p> 		
<p>2.9 Are there elevators or platform lifts to all public stories?*</p>	<p><input checked="" type="checkbox"/> Yes <input type="checkbox"/> No</p>			
<p>Elevators – Full Size & LULA (limited use, limited application) (2010 Standards – 407 & 408) Note: LULA elevators are often used in alterations.</p>				
<p>2.22 If there is a full size or LULA elevator, are the call buttons no higher than 54 inches above the floor?</p>	<p><input checked="" type="checkbox"/> Yes <input type="checkbox"/> No Measurement:</p>			

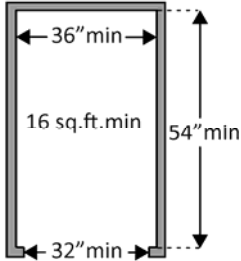
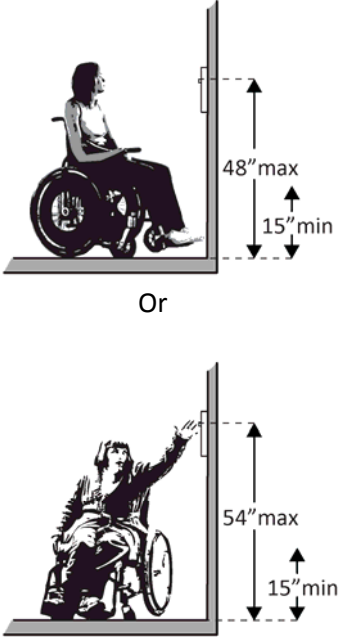
<p>2.23 If there is a full size or LULA elevator, does the sliding door reopen automatically when obstructed by an object or person?*</p>	<p><input checked="" type="checkbox"/> Yes <input type="checkbox"/> No</p>			
<p>2.25 If there is a full size elevator:</p> <p>Is the interior at least 54 inches deep by at least 36 inches wide with at least 16 sq. ft. of clear floor area?</p> <p>Is the door opening width at least 32 inches?</p>	<p><input checked="" type="checkbox"/> Yes <input type="checkbox"/> No Measurement:</p> <p><input checked="" type="checkbox"/> Yes <input type="checkbox"/> No Measurement:</p>			
<p>2.27 If there is a full size or LULA elevator, are the in-car controls:</p> <p>No less than 15 inches and no greater 48 inches above the floor?</p> <p>Or</p> <p>Up to 54 inches above the floor for a parallel approach?</p>	<p><input checked="" type="checkbox"/> Yes <input type="checkbox"/> No Measurement:</p> <p><input checked="" type="checkbox"/> Yes <input type="checkbox"/> No Measurement:</p>			

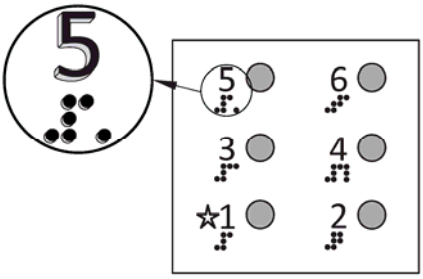
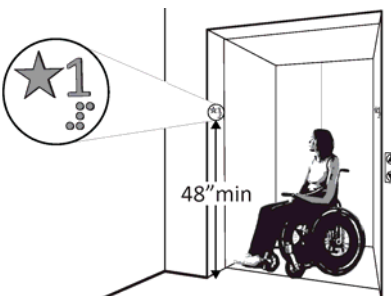
<p>2.29 If there is a full size or LULA elevator:</p> <p>Are the car control buttons designated with raised characters?</p> <p>Are the car control buttons designated with Braille?</p>	<p><input checked="" type="checkbox"/> Yes <input type="checkbox"/> No</p> <p><input checked="" type="checkbox"/> Yes <input type="checkbox"/> No</p>			
<p>2.30 If there is a full size or LULA elevator, are there audible signals which sound as the car passes or is about to stop at a floor?</p>	<p><input checked="" type="checkbox"/> Yes <input type="checkbox"/> No</p>			
<p>2.31 If there is a full size or LULA elevator:</p> <p>Is there a sign on both door jambs at every floor identifying the floor?</p> <p>Is there a tactile star on both jambs at the main entry level?</p> <p>Do text characters contrast with their backgrounds?</p> <p>Are text characters raised?</p> <p>Is there Braille?</p> <p>Is the sign mounted between 48 inches to the baseline of the lowest character and 60 inches to the baseline of the highest character above the floor?*</p>	<p><input checked="" type="checkbox"/> Yes <input type="checkbox"/> No</p> <p><input checked="" type="checkbox"/> Yes <input type="checkbox"/> No</p> <p><input checked="" type="checkbox"/> Yes <input type="checkbox"/> No</p> <p><input checked="" type="checkbox"/> Yes <input type="checkbox"/> No</p> <p><input checked="" type="checkbox"/> Yes <input type="checkbox"/> No</p> <p><input checked="" type="checkbox"/> Yes <input type="checkbox"/> No</p> <p>Measurement:</p>			

Seating: General – reception areas, waiting rooms, etc. (2010 Standards – 801)

2.68 Is there at least one space at least 36 inches wide by at least 48 inches long for a person in a wheelchair?

Yes No

Measurement:

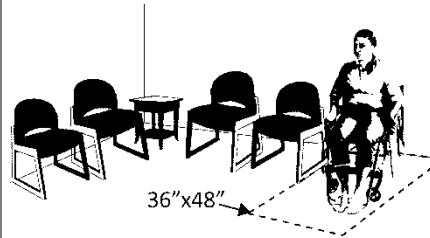

Sales & Service Counters – banks, stores, dry cleaners, auto repair shops, fitness clubs, etc. (2010 Standards – 904)

2.76 Is there a portion of at least one of each type of counter that is:

No higher than 36 inches above the floor?

Yes No

Measurement:

At least 36 inches long?

Yes No

Measurement:

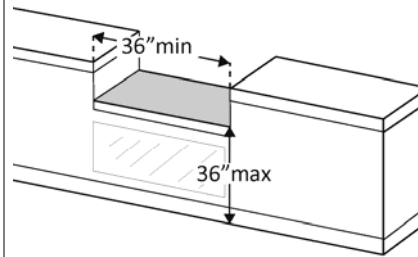

2.77 Does the accessible portion of the counter extend the same depth as the counter top?

Yes No

Measurement:

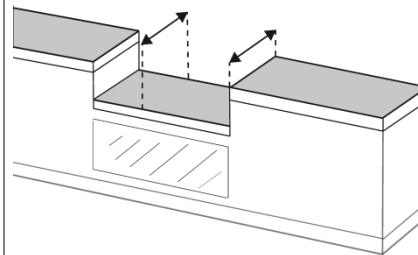

<p>2.78 Is there a clear floor space at least 30 inches wide by at least 48 inches long for a forward or parallel approach?</p>	<p><input checked="" type="checkbox"/> Yes <input type="checkbox"/> No</p> <p><input type="checkbox"/> Parallel Measurement:</p> <p><input type="checkbox"/> Forward Measurement:</p>			
<p>2.79 For a parallel approach, is the clear floor space positioned with the 48 inches adjacent to the accessible length of counter?</p>	<p><input checked="" type="checkbox"/> Yes <input type="checkbox"/> No</p> <p>Measurement:</p>			
<p>2.80 For a forward approach:</p> <p>Do no less than 17 and no greater than 25 inches of the clear floor space extend under the accessible length of the counter?</p> <p>Is there at least 27 inches clearance from the floor to the</p>	<p><input type="checkbox"/> Yes <input checked="" type="checkbox"/> No</p> <p>Measurement:</p> <p><input type="checkbox"/> Yes <input type="checkbox"/> No</p>		<p>Greater than 25" deep at second floor information counter</p>	<ul style="list-style-type: none"> • Reconfigure to provide knee clearance



<p>bottom of the counter?</p>	<p>Measurement:</p>			
<p>Holding Cells (2010 Standards –807)</p>				
<p>2.103 In holding cells with mobility features, is 30"x48" clear space provided on at least one side of bed?</p>	<p><input checked="" type="checkbox"/> Yes <input type="checkbox"/> No Measurement:</p>			
<p>2.104 Is a 60" turn around provided?</p>	<p><input type="checkbox"/> Yes <input checked="" type="checkbox"/> No</p>			<ul style="list-style-type: none"> • Reconfigure desk/stool to provide clearance

Photo #002

2.105 If toilet facilities are provided in holding cells, are an accessible toilet, sink and shower/tub provided?	<input checked="" type="checkbox"/> Yes <input type="checkbox"/> No			
--------------------------------------------------------------------------------------------------------------------------	---------------------------------------------------------------------	--	--	--

The ADA Checklist for Readily Achievable Barrier Removal

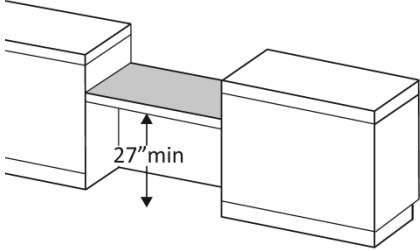
Priority 3 - Toilet Rooms

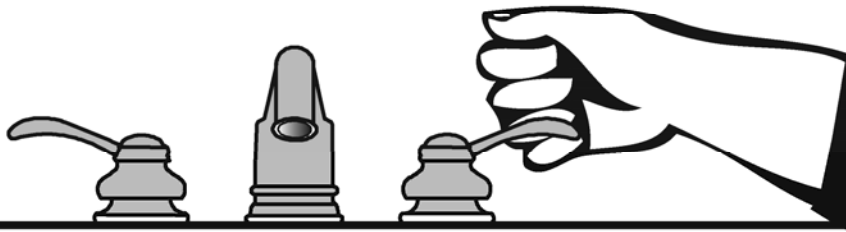

Project _____

Building _____

Location _____

Date _____

Surveyors _____

Contact Information _____

When toilet rooms are open to the public they should be accessible to people with disabilities.



Institute for Human Centered Design
www.HumanCenteredDesign.org
November 2011



ADA National Network
Questions on the ADA 800-949-4232 voice/tty
www.ADAchecklist.org

This checklist was produced by the New England ADA Center, a project of the Institute for Human Centered Design and a member of the ADA National Network. This checklist was developed under a grant from the Department of Education, NIDRR grant number H133A060092-09A. However the contents do not necessarily represent the policy of the Department of Education, and you should not assume endorsement by the Federal Government.

Questions or comments on the checklist contact the New England ADA Center at 617-695-0085 voice/tty or ADAinfo@NewEnglandADA.org

For the full set of checklists, including the checklists for recreation facilities visit www.ADAchecklist.org.

Priority 3 – Toilet Rooms			Comments	Possible Solutions
<p>3.1 If toilet rooms are available to the public, is at least one toilet room accessible? (Either one for each sex, or one unisex.)</p>	<p><input type="checkbox"/> Yes <input checked="" type="checkbox"/> No</p>		<p>Public Toilets are entirely non-compliant.</p>	<ul style="list-style-type: none"> • Reconfigure toilet rooms • Combine toilet rooms to create one unisex accessible toilet room

ADA Checklist for Readily Achievable Barrier Removal

Priority 4 – Additional Access

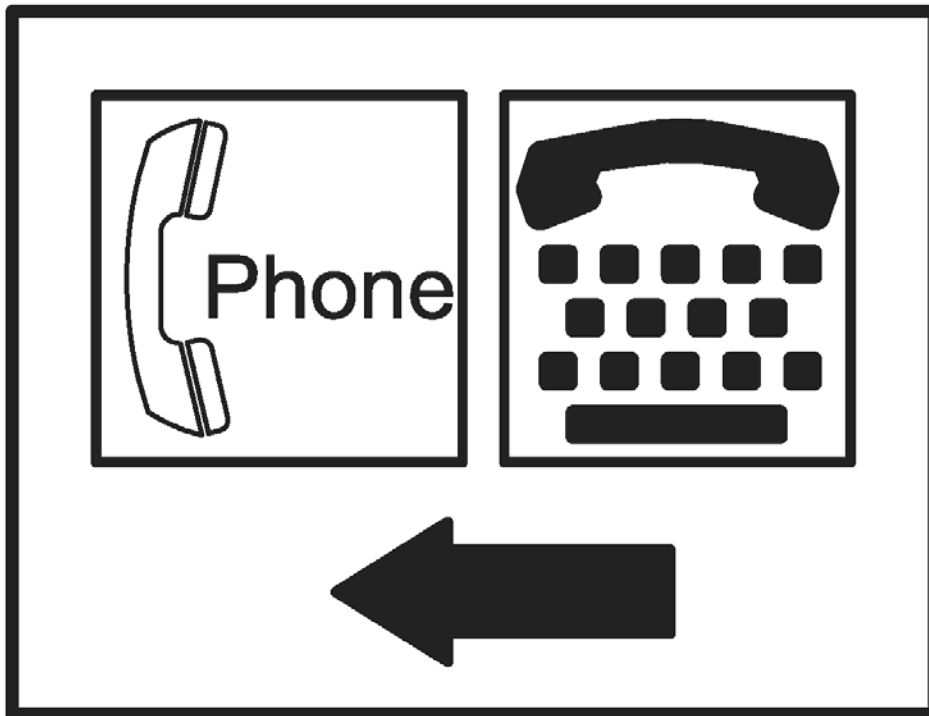

Project _____

Building _____

Location _____

Date _____

Surveyors _____

Contact Information _____

Amenities such as drinking fountains and public telephones should be accessible to people with disabilities.



Institute for Human Centered Design
www.HumanCenteredDesign.org
November 2011





ADA National Network
Questions on the ADA 800-949-4232 voice/tty
www.ADAchecklist.org

This checklist was produced by the New England ADA Center, a project of the Institute for Human Centered Design and a member of the ADA National Network. This checklist was developed under a grant from the Department of Education, NIDRR grant number H133A060092-09A. However the contents do not necessarily represent the policy of the Department of Education, and you should not assume endorsement by the Federal Government.



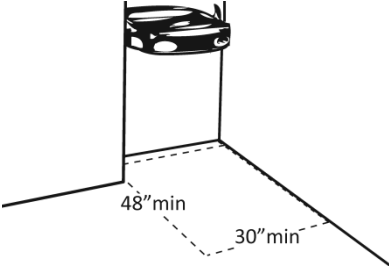
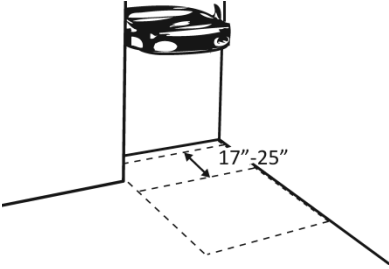
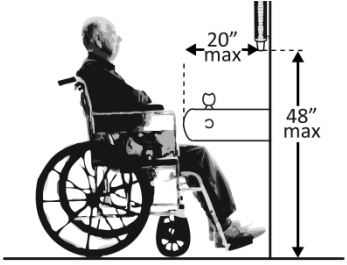

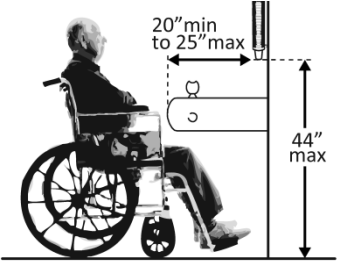
Questions or comments on the checklist contact the New England ADA Center at 617-695-0085 voice/tty or ADAinfo@NewEnglandADA.org

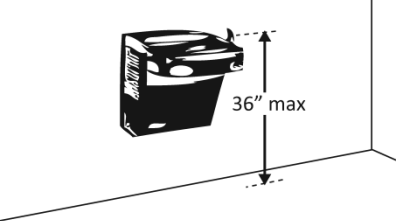
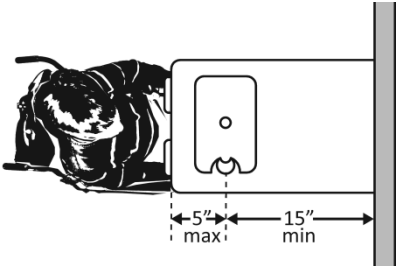

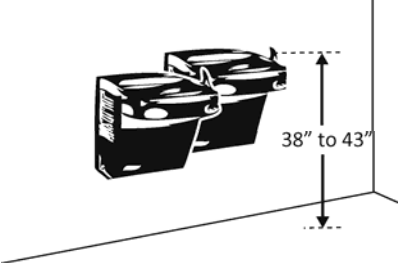
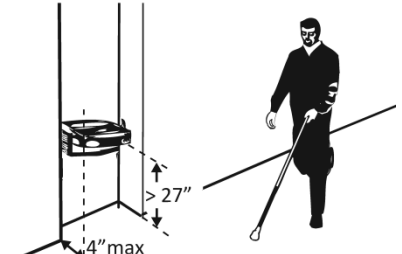
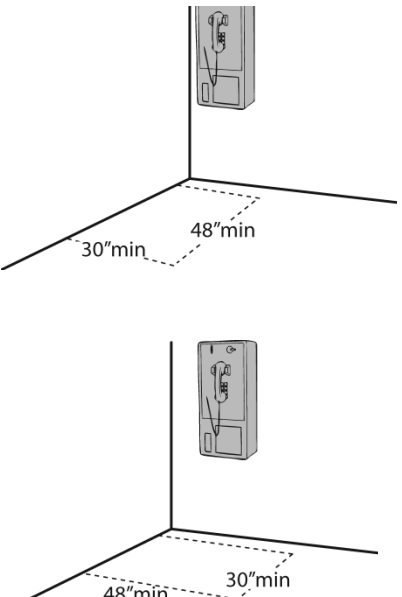
For the full set of checklists, including the checklists for recreation facilities visit www.ADAchecklist.org.

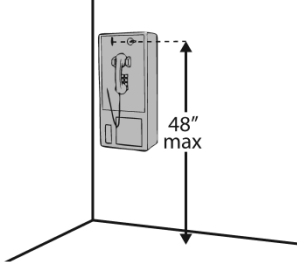
Priority 4 – Additional Access		Comments	Possible Solutions
Drinking Fountains (2010 Standards – 602)			
<p>4.1 Does at least one drinking fountain have a clear floor space at least 30 inches wide x at least 48 inches long centered in front of it for a forward approach?*</p>	<p><input type="checkbox"/> Yes <input type="checkbox"/> No</p> <p>Measurement:</p>		<p>***Drinking fountain needs to be verified.***</p> <p>*If installed before 3/15/2012, a parallel approach is permitted and the clear floor space is not required to be centered</p> <ul style="list-style-type: none"> • Alter space • Relocate drinking fountain • Install a drinking fountain in another location
<p>4.2 If there is a forward approach, do no less than 17 inches and no greater than 25 inches of the clear floor space extend under the drinking fountain?</p>	<p><input type="checkbox"/> Yes <input type="checkbox"/> No</p> <p>Measurement:</p>		<p>Photo #:</p> <ul style="list-style-type: none"> • Alter space • Replace drinking fountain •
<p>4.3 If the drinking fountain is no deeper than 20 inches, are the operable parts no higher than 48 inches above the floor?</p>	<p><input type="checkbox"/> Yes <input type="checkbox"/> No</p> <p>Measurement:</p>		<p>Photo #:</p> <ul style="list-style-type: none"> • Adjust drinking fountain • Replace drinking fountain •

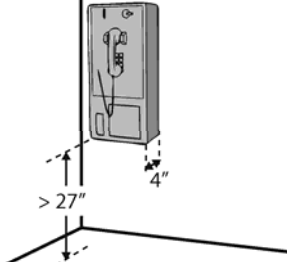
<p>4.4 If the drinking fountain is no less than 20 inches and no greater than 25 inches deep, are the operable parts no higher than 44 inches above the floor?</p>	<p><input type="checkbox"/> Yes <input type="checkbox"/> No</p> <p>Measurement:</p>		<p>Photo #:</p>	<ul style="list-style-type: none"> • Adjust drinking fountain • Replace drinking fountain •
<p>4.5 Can the control be operated with one hand and without tight grasping, pinching or twisting of the wrist?</p> <p>Is the force required to activate the control no more than 5 pounds?</p>	<p><input type="checkbox"/> Yes <input type="checkbox"/> No</p> <p><input type="checkbox"/> Yes <input type="checkbox"/> No</p> <p>Measurement:</p>		<p>Photo #:</p>	<ul style="list-style-type: none"> • Change control • Adjust control •
<p>4.6 Is the spout outlet no higher than 36 inches above the floor?</p>	<p><input type="checkbox"/> Yes <input type="checkbox"/> No</p> <p>Measurement:</p>		<p>Photo #:</p>	<ul style="list-style-type: none"> • Adjust drinking fountain • Replace drinking fountain •
<p>4.7 Is the spout:</p> <p>At least 15 inches from the rear of the drinking fountain?</p> <p>No more than 5 inches from the front of the drinking fountain?</p>	<p><input type="checkbox"/> Yes <input type="checkbox"/> No</p> <p>Measurement:</p> <p><input type="checkbox"/> Yes <input type="checkbox"/> No</p> <p>Measurement:</p>		<p>Photo #:</p>	<ul style="list-style-type: none"> • Adjust spout • Replace drinking fountain •

<p>4.8 If there is more than one drinking fountain, is there at least one for standing persons?</p> <p>Is the spout outlet no lower than 38 inches and no higher than 43 inches above the floor?</p>	<p><input type="checkbox"/> Yes <input type="checkbox"/> No</p> <p><input type="checkbox"/> Yes <input type="checkbox"/> No</p> <p>Measurement:</p>		<p>Photo #:</p>	<ul style="list-style-type: none"> • Adjust drinking fountain • Install new drinking fountain for standing height •
<p>4.9 If the leading (bottom) edge of the fountain is higher than 27 inches above the floor, does the front of the fountain protrude no more than 4 inches into the circulation path?</p>	<p><input type="checkbox"/> Yes <input type="checkbox"/> No</p> <p>Measurement:</p>		<p>Photo #:</p>	<ul style="list-style-type: none"> • Adjust drinking fountain • Replace drinking fountain • Add tactile warning such as permanent planter or partial walls
<p>Public Telephones (2010 Standards – 704) TTY's are devices that employ interactive text-based communication through the transmission of coded signals across the telephone network. They are mainly used by people who are deaf and/or cannot speak.</p>				
<p>4.10 Does at least one telephone have a clear floor space at least 30 inches wide x at least 48 inches long for a parallel or forward approach?</p>	<p><input checked="" type="checkbox"/> Yes <input type="checkbox"/> No</p>		<p>Photo #:</p>	

<p>4.11 Is the highest operable part of the telephone no higher than 48 inches above the floor?</p>	<p><input type="checkbox"/> Yes <input checked="" type="checkbox"/> No Measurement: 52"</p>		 <p>Photo #003</p>	<ul style="list-style-type: none"> • Adjust telephone
<p>4.12 If the leading (bottom) edge of the telephone is higher than 27 inches above the floor, does the front of the telephone protrude no more than 4 inches into the circulation path?</p>	<p><input checked="" type="checkbox"/> Yes <input type="checkbox"/> No Measurement:</p>			
<p>4.13 Does at least one telephone have a volume control?</p>	<p><input checked="" type="checkbox"/> Yes <input type="checkbox"/> No</p>			
<p>4.14 Is the volume control identified by a pictogram of a telephone handset with radiating sound waves?</p>	<p><input checked="" type="checkbox"/> Yes <input type="checkbox"/> No</p>			

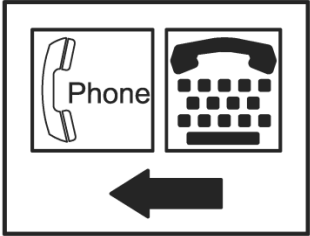
<p>4.15 Does at least one telephone have a TTY?</p>	<p><input type="checkbox"/> Yes <input checked="" type="checkbox"/> No</p>		<ul style="list-style-type: none"> • Install TTY
<p>4.16 Is the touch surface of the TTY keypad at least 34 inches above the floor?</p>	<p><input type="checkbox"/> Yes <input checked="" type="checkbox"/> No Measurement:</p>		
<p>4.17 Is the TTY identified by the International Symbol of TTY?</p>	<p><input type="checkbox"/> Yes <input checked="" type="checkbox"/> No</p>		<ul style="list-style-type: none"> • Add symbol
<p>4.18 Do signs that provide direction to public telephones also provide direction to the TTY?</p>	<p><input type="checkbox"/> Yes <input checked="" type="checkbox"/> No</p>		<ul style="list-style-type: none"> • Add signs



<p>4.19 Do telephones that do not have a TTY provide direction to the TTY?</p>	<p><input type="checkbox"/> Yes <input checked="" type="checkbox"/> No</p>				<ul style="list-style-type: none"> • Add signs
---------------------------------------------------------------------------------------	----------------------------------------------------------------------------	-------------------------------------------------------------------------------------	-------------------------------------------------------------------------------------	--	---------------------------------------------------------------



Photo #001



Photo #002



Photo #003

ADA Checklist for Readily Achievable Barrier Removal

Priority 1 – Approach & Entrance



Project Cass County ADA Transition Plan

Building County Highway Maintenance Building

Location Logansport, IN

Date 12/10/2012

Surveyors Henry Stellema & Dustin Schrougham

Contact Information 1-800-321-6959

An accessible route from site arrival points and an accessible entrance should be provided for everyone.



Institute for Human Centered Design
www.HumanCenteredDesign.org

November 2011



ADA National Network
Questions on the ADA 800-949-4232 voice/tty

www.ADAchecklist.org

This checklist was produced by the New England ADA Center, a project of the Institute for Human Centered Design and a member of the ADA National Network. This checklist was developed under a grant from the Department of Education, NIDRR grant number H133A060092-09A. However the contents do not necessarily represent the policy of the Department of Education, and you should not assume endorsement by the Federal Government.

Questions or comments on the checklist contact the New England ADA Center at 617-695-0085 voice/tty or ADAinfo@NewEnglandADA.org

For the full set of checklists, including the checklists for recreation facilities visit www.ADAchecklist.org.

Priority 1 – Approach & Entrance		Comments	Possible Solutions												
<p>1.1 Is there at least one route from site arrival points (parking, passenger loading zones, public sidewalks and public transportation stops) that does not require the use of stairs?</p>	<p><input checked="" type="checkbox"/> Yes <input type="checkbox"/> No</p> <p>If yes, location of route:</p>														
<p>Parking (2010 Standards – 208 & 502) Note: Accessible parking spaces should be identified by size, access aisle and signage.</p>															
<p>1.2 If parking is provided for the public, are an adequate number of accessible spaces provided?</p>	<p><input type="checkbox"/> Yes <input checked="" type="checkbox"/> No</p> <p>Total #:</p> <p>Accessible #:</p>	<table border="1"> <thead> <tr> <th>Total Spaces</th> <th>Accessible Spaces</th> </tr> </thead> <tbody> <tr> <td>1 - 25</td> <td>1</td> </tr> <tr> <td>26 - 50</td> <td>2</td> </tr> <tr> <td>51 - 75</td> <td>3</td> </tr> <tr> <td>76 - 100</td> <td>4</td> </tr> <tr> <td>100+ see 2010 Standards 208.2</td> <td></td> </tr> </tbody> </table>	Total Spaces	Accessible Spaces	1 - 25	1	26 - 50	2	51 - 75	3	76 - 100	4	100+ see 2010 Standards 208.2		<ul style="list-style-type: none"> • Provide ADA parking.
Total Spaces	Accessible Spaces														
1 - 25	1														
26 - 50	2														
51 - 75	3														
76 - 100	4														
100+ see 2010 Standards 208.2															

Exterior Accessible Route (2010 Standards – Ch.4)			
<p>1.13 Is the route stable, firm and slip-resistant?</p>	<p><input type="checkbox"/> Yes <input checked="" type="checkbox"/> No</p>		 <p>Photo #001</p> <ul style="list-style-type: none"> • Repair uneven paving • Fill small bumps and breaks with patches • Replace gravel with asphalt or other surface

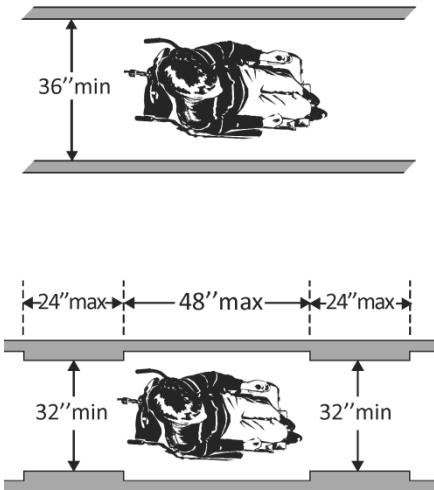
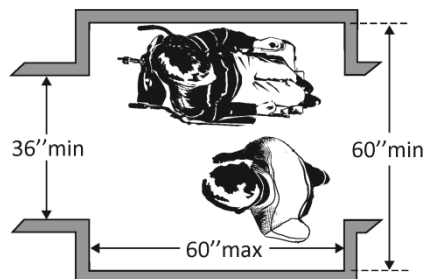
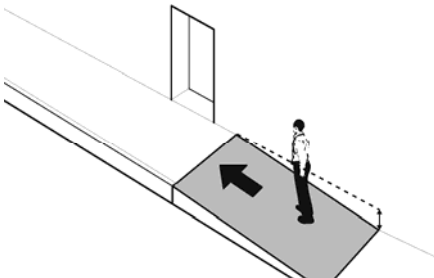

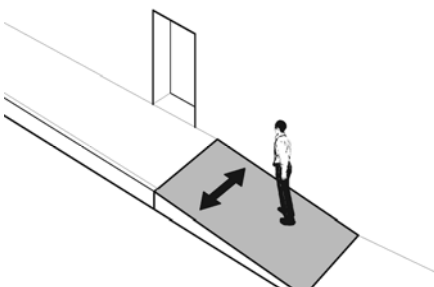
<p>1.14 Is the route at least 36 inches wide?</p> <p>Note: The accessible route can narrow to 32 inches min. for a max. of 24 inches. These narrower portions of the route must be at least 48 inches from each other.</p>	<p><input checked="" type="checkbox"/> Yes <input type="checkbox"/> No</p> <p>Measurement:</p>			
<p>1.15 If the route is greater than 200 feet in length and no less than 60 inches wide, is there a passing space no less than 60 x 60 inches?</p>	<p><input checked="" type="checkbox"/> Yes <input type="checkbox"/> No</p> <p>Measurement:</p>			
<p>1.17 Is the running slope no steeper than 1:20, i.e. for every inch of height change there are at least 20 inches of route run?</p>	<p><input checked="" type="checkbox"/> Yes <input type="checkbox"/> No</p> <p>Measurement:</p>			



<p>1.18 Is the cross slope no steeper than 1:48?</p>	<p><input checked="" type="checkbox"/> Yes <input type="checkbox"/> No</p> <p>Measurement:</p>			
-------------------------------------------------------------	------------------------------------------------------------------------------------------------	------------------------------------------------------------------------------------	--	--

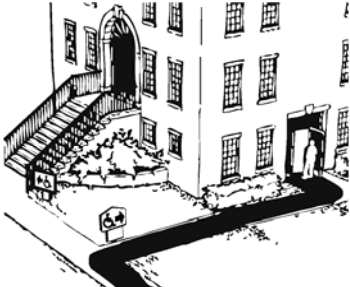

Entrance (2010 Standards – 404)

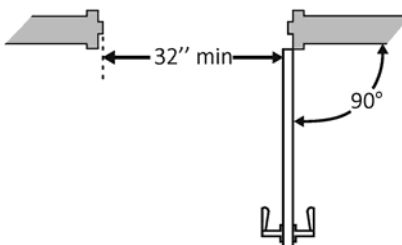
<p>1.37 Is the main entrance accessible?</p>	<p><input type="checkbox"/> Yes <input checked="" type="checkbox"/> No</p>		 <p>Photo #002</p>	<ul style="list-style-type: none"> • Redesign to make it accessible
-----------------------------------------------------	----------------------------------------------------------------------------	--	--------------------------------------------------------------------------------------------------------	------------------------------------------------------------------------------------

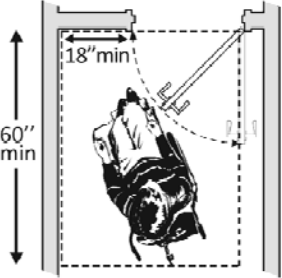
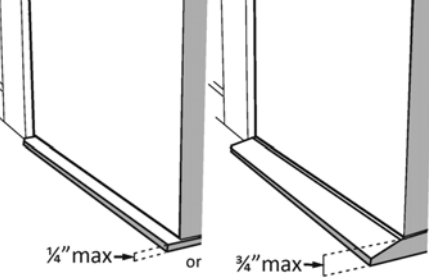
<p>1.38 If the main entrance is not accessible, is there an alternative accessible entrance?</p> <p>Can the alternative accessible entrance be used independently and during the same hours as the main entrance?</p>	<p><input type="checkbox"/> Yes <input checked="" type="checkbox"/> No</p> <p><input type="checkbox"/> Yes <input checked="" type="checkbox"/> No</p>			<ul style="list-style-type: none"> • Ensure that accessible entrance can be used independently and during the same hours as the main entrance
------------------------------------------------------------------------------------------------------------------------------------------------------------------------------------------------------------------------------	-------------------------------------------------------------------------------------------------------------------------------------------------------	--------------------------------------------------------------------------------------	--	--------------------------------------------------------------------------------------------------------------------------------------------------------------

				
<p>1.39 Do all inaccessible entrances have signs indicating the location of the nearest accessible entrance?</p>	<p><input type="checkbox"/> Yes <input checked="" type="checkbox"/> No</p>			<ul style="list-style-type: none"> • Install signs
<p>1.40 If not all entrances are accessible, is there a sign at the accessible entrance with the International Symbol of Accessibility?</p>	<p><input type="checkbox"/> Yes <input checked="" type="checkbox"/> No</p>			<ul style="list-style-type: none"> • Install sign
<p>1.41 Is the clear opening width of the accessible entrance door at least 32 inches, between the face of the door and the stop, when the door is open 90 degrees?</p>	<p><input checked="" type="checkbox"/> Yes <input type="checkbox"/> No</p> <p>Measurement:</p>			

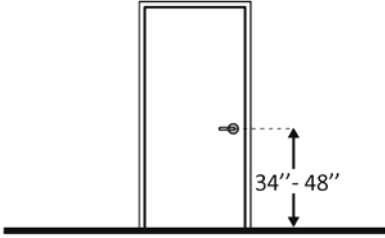
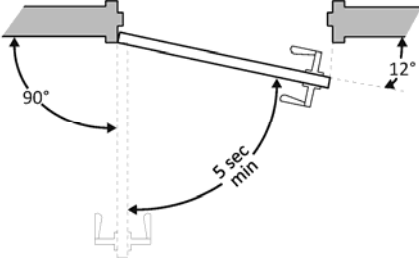
<p>1.42 If there is a front approach to the pull side of the door, is there at least 18 inches of maneuvering clearance beyond the latch side plus at least 60 inches clear depth?</p> <p>On both sides of the door, is the ground or floor surface of the maneuvering clearance level (no steeper than 1:48)?</p>	<p><input type="checkbox"/> Yes <input checked="" type="checkbox"/> No</p> <p>Measurement:</p> <p><input type="checkbox"/> Yes <input checked="" type="checkbox"/> No</p> <p>Measurement:</p>			<p>See 2010 Standards 404.2.4 for maneuvering clearance requirements on the push side of the door and side approaches to the pull side of the door</p> <ul style="list-style-type: none"> • Reconfigure walls • Add automatic door opener
<p>1.43 Is the door threshold edge no more than ¼ inch high?</p> <p>Or</p> <p>No more than ¾ inch high if slope is beveled no steeper than 1:2?</p> <p>Note: The first ¼ inch of the threshold may be vertical; the rest must be beveled.</p>	<p><input checked="" type="checkbox"/> Yes <input type="checkbox"/> No</p> <p>Measurement:</p> <p><input checked="" type="checkbox"/> Yes <input type="checkbox"/> No</p> <p>Measurement:</p>			
<p>1.44 Is the door equipped with hardware, including locks, that is operable with one hand and does not require tight grasping, pinching, or twisting of the wrist?</p>	<p><input checked="" type="checkbox"/> Yes <input type="checkbox"/> No</p>			

<p>1.45 Are the operable parts of the door hardware no less than 34 inches and no greater than 48 inches above the floor or ground surface?</p>	<p><input checked="" type="checkbox"/> Yes <input type="checkbox"/> No</p> <p>Measurement:</p>			
<p>1.46 If the door has a closer, does it take at least 5 seconds to close from an open position of 90 degrees to a position of 12 degrees from the latch?</p>	<p><input type="checkbox"/> Yes <input checked="" type="checkbox"/> No</p> <p>Measurement:</p>			<ul style="list-style-type: none"> • Adjust closer
<p>1.48 If provided at the building entrance, are carpets or mats no higher than 1/2 inch thick?</p>	<p><input checked="" type="checkbox"/> Yes <input type="checkbox"/> No</p> <p>Measurement:</p>			
<p>1.49 Are edges of carpets or mats securely attached to minimize tripping hazards?</p>	<p><input type="checkbox"/> Yes <input checked="" type="checkbox"/> No</p>			<ul style="list-style-type: none"> • Secure carpeting or mats at edges

ADA Checklist for Readily Achievable Barrier Removal

Priority 2 – Access to Goods & Services

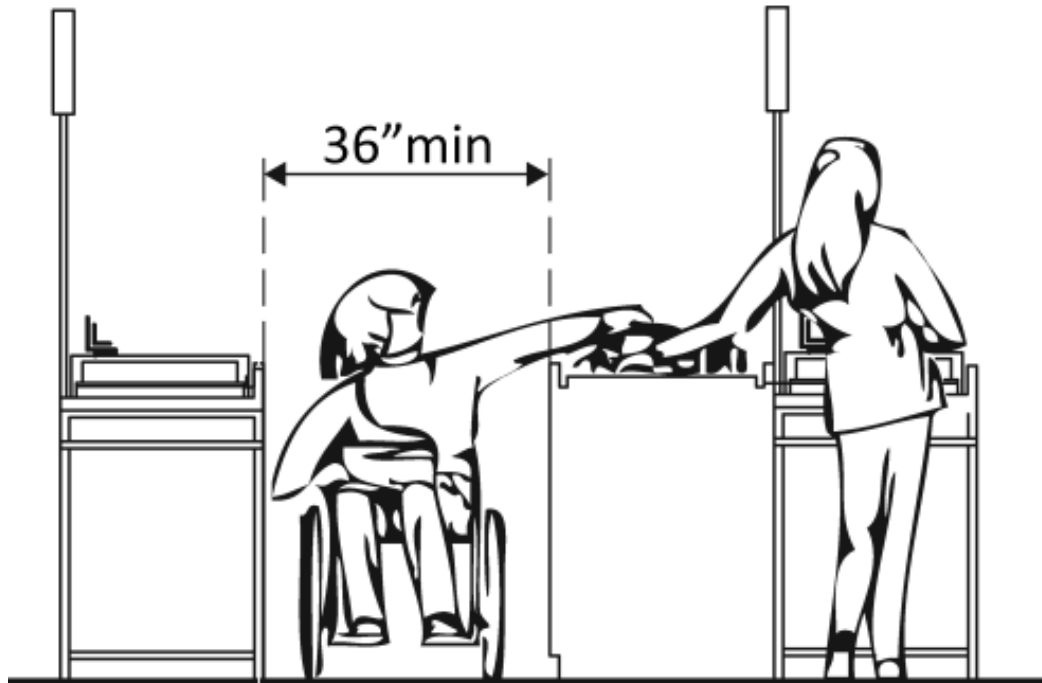

Project _____

Building _____

Location _____

Date _____

Surveyors _____

Contact Information _____

The layout of the building should allow people with disabilities to obtain goods and services and to participate in activities without assistance.



Institute for Human Centered Design
www.HumanCenteredDesign.org
November 2011





ADA National Network
Questions on the ADA 800-949-4232 voice/tty
www.ADAchecklist.org

This checklist was produced by the New England ADA Center, a project of the Institute for Human Centered Design and a member of the ADA National Network. This checklist was developed under a grant from the Department of Education, NIDRR grant number H133A060092-09A. However the contents do not necessarily represent the policy of the Department of Education, and you should not assume endorsement by the Federal Government.

Questions or comments on the checklist contact the New England ADA Center at 617-695-0085 voice/tty or ADAinfo@NewEnglandADA.org

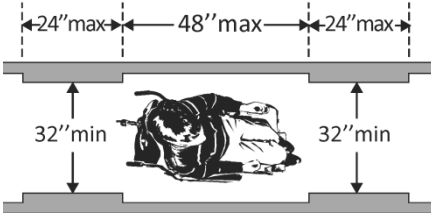
For the full set of checklists, including the checklists for recreation facilities visit www.ADAchecklist.org.

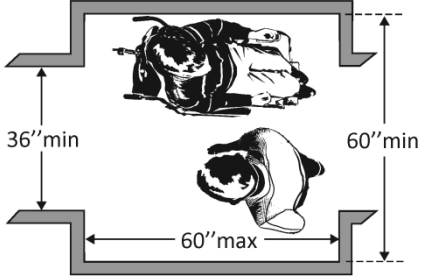
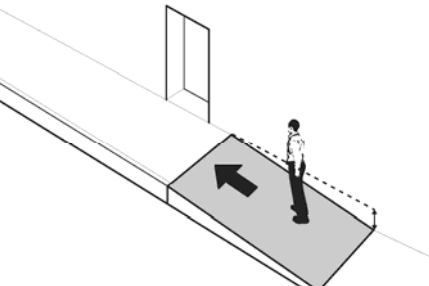
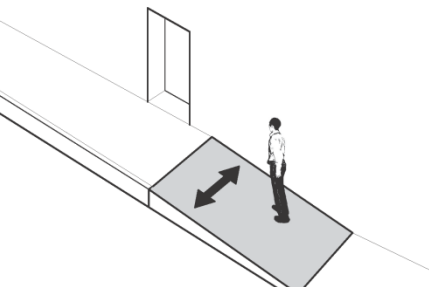
Priority 2 – Access to Goods & Services		Comments	Possible Solutions
<p>2.1 Does the accessible entrance provide direct access to the main floor, lobby and elevator?</p> <p><input checked="" type="checkbox"/> Yes <input type="checkbox"/> No</p>			
<p>Interior Accessible Route (2010 Standards – Ch.4)</p>			
<p>2.2 Are all public spaces on at least one accessible route?</p> <p><input checked="" type="checkbox"/> Yes <input type="checkbox"/> No</p>			
<p>2.3 Is the route stable, firm and slip-resistant?</p> <p><input checked="" type="checkbox"/> Yes <input type="checkbox"/> No</p>			
<p>2.4 Is the route at least 36 inches wide?</p> <p>Note: The accessible route can narrow to 32 inches min. for a max. of 24 inches. These narrower portions of the route must be at least 48 inches from each other.</p> <p>Measurement:</p>	 		

<p>2.5 If the route is greater than 200 feet in length and no less than 36 inches wide, is there a passing space no less than 60 x 60 inches?</p>	<p><input checked="" type="checkbox"/> Yes <input type="checkbox"/> No</p> <p>Measurement:</p>			
<p>2.6 Is the running slope no steeper than 1:20, i.e. for every inch of height change there are at least 20 inches of route run?</p>	<p><input checked="" type="checkbox"/> Yes <input type="checkbox"/> No</p> <p>Measurement:</p>			
<p>2.7 Is the cross slope no steeper than 1:48?</p>	<p><input checked="" type="checkbox"/> Yes <input type="checkbox"/> No</p> <p>Measurement:</p>			
<p>2.8 Do all objects on circulation paths through public areas, e.g. fire extinguishers, drinking fountains, signs, etc., protrude no more than 4 inches into the path? Or If an object protrudes more than 4 inches, is the bottom leading edge at 27 inches or lower above the floor?</p>	<p><input checked="" type="checkbox"/> Yes <input type="checkbox"/> No</p> <p>Measurement:</p> <p><input type="checkbox"/> Yes <input type="checkbox"/> No</p> <p>Measurement:</p>	 <p style="text-align: center;">Or</p>		

Or
Is the bottom leading edge at 80 inches or higher above the floor?

Yes No

Measurement:

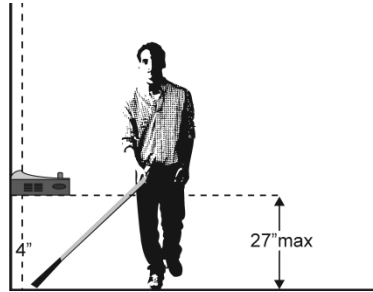

Or

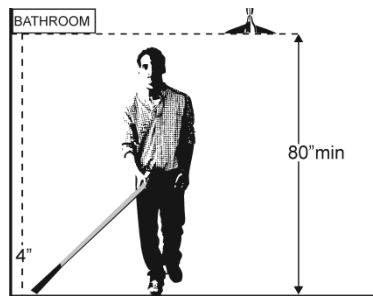

Interior Doors – to classrooms, medical exam rooms, conference rooms, etc. (2010 Standards – 404)



2.40 Is the door opening width at least 32 inches clear, between the face of the door and the stop, when the door is open 90 degrees?

Yes No

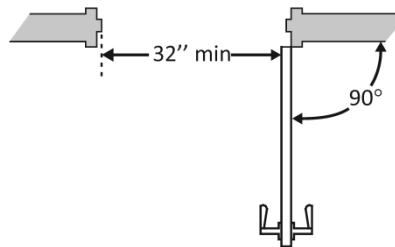
Measurement:

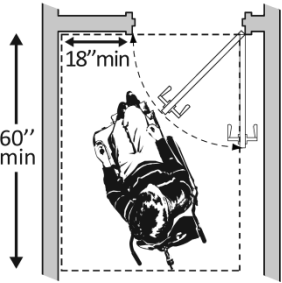
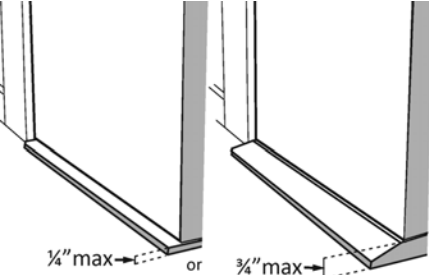
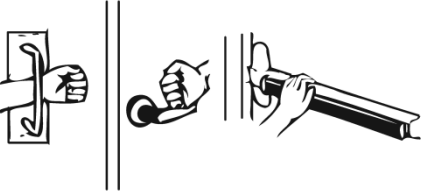

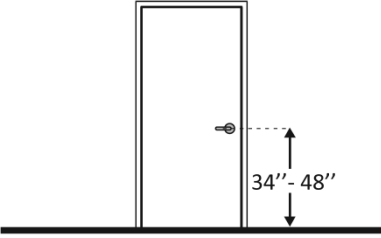
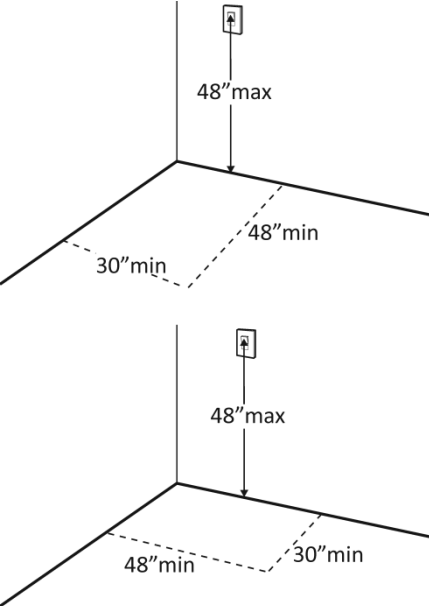
<p>2.41 If there is a front approach to the pull side of the door, is there at least 18 inches of maneuvering clearance beyond the latch side plus at least 60 inches clear depth?</p> <p>On both sides of the door, is the floor surface of the maneuvering clearance level (no steeper than 1:48)?</p>	<p><input type="checkbox"/> Yes <input checked="" type="checkbox"/> No</p> <p>Measurement:</p> <p><input type="checkbox"/> Yes <input type="checkbox"/> No</p> <p>Measurement:</p>		<p>Main office door</p>	<ul style="list-style-type: none"> • Reconfigure walls <p>See 2010 Standards 404.2.4 for maneuvering clearance requirements on the push side of the door and side approaches to the pull side of the door</p>
<p>2.42 Is the door threshold edge no more than ¼ inch high?</p> <p>Or</p> <p>No more than ¾ inch high if slope is beveled no steeper than 1:2?</p> <p>Note: The first ¼ inch of the threshold may be vertical; the rest must be beveled.</p>	<p><input checked="" type="checkbox"/> Yes <input type="checkbox"/> No</p> <p>Measurement:</p> <p><input checked="" type="checkbox"/> Yes <input type="checkbox"/> No</p> <p>Measurement:</p>			
<p>2.43 Is the door equipped with hardware that is operable with one hand and does not require tight grasping, pinching and twisting of the wrist?</p>	<p><input type="checkbox"/> Yes <input checked="" type="checkbox"/> No</p>			<ul style="list-style-type: none"> • Replace inaccessible knob with lever, loop or push hardware

<p>2.44 Are the operable parts of the hardware no less than 34 inches and no greater than 48 inches above the floor?</p>	<p><input checked="" type="checkbox"/> Yes <input type="checkbox"/> No</p> <p>Measurement:</p>			
<p>Controls – light switches, security and intercom systems, emergency/alarm boxes, etc. (2010 Standards – 309)</p>				
<p>2.50 Is there a clear floor space at least 30 inches wide by at least 48 inches long for a forward or parallel approach?</p> <p>Are the operable parts no higher than 48 inches above the floor?*</p>	<p><input checked="" type="checkbox"/> Yes <input type="checkbox"/> No</p> <p>Measurement:</p> <p><input checked="" type="checkbox"/> Yes <input type="checkbox"/> No</p> <p>Measurement:</p>			
<p>2.51 Can the control be operated with one hand and without tight grasping, pinching, or twisting of the wrist?</p>	<p><input checked="" type="checkbox"/> Yes <input type="checkbox"/> No</p>			

Seating: Assembly Areas – theaters, auditoriums, stadiums, theater style classrooms, etc. (2010 Standards – 221 & 802)

2.52 Are an adequate number of wheelchair spaces provided?

Yes No

Total #:

Wheelchair #:

# of Seats	Wheelchair Spaces
4 - 25	1
26 - 50	2
51 - 150	4
151 - 300	5
300+ see 2010 Standards 221.2.1.	

Seating: General – reception areas, waiting rooms, etc. (2010 Standards – 801)

2.68 Is there at least one space at least 36 inches wide by at least 48 inches long for a person in a wheelchair?

Yes No

Measurement:

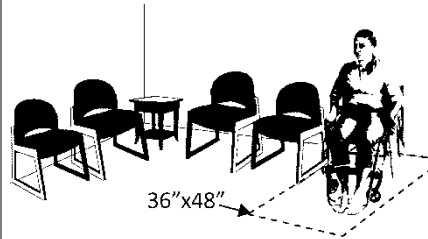

The ADA Checklist for Readily Achievable Barrier Removal

Priority 3 - Toilet Rooms

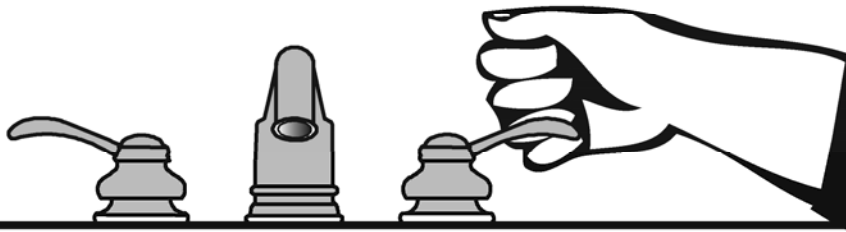

Project

Building

Location

Date

Surveyors

Contact Information

When toilet rooms are open to the public they should be accessible to people with disabilities.



Institute for Human Centered Design
www.HumanCenteredDesign.org
November 2011





ADA National Network
Questions on the ADA 800-949-4232 voice/tty
www.ADAchecklist.org

This checklist was produced by the New England ADA Center, a project of the Institute for Human Centered Design and a member of the ADA National Network. This checklist was developed under a grant from the Department of Education, NIDRR grant number H133A060092-09A. However the contents do not necessarily represent the policy of the Department of Education, and you should not assume endorsement by the Federal Government.

Questions or comments on the checklist contact the New England ADA Center at 617-695-0085 voice/tty or ADAinfo@NewEnglandADA.org

For the full set of checklists, including the checklists for recreation facilities visit www.ADAchecklist.org.

Priority 3 – Toilet Rooms			Comments	Possible Solutions
<p>3.1 If toilet rooms are available to the public, is at least one toilet room accessible? (Either one for each sex, or one unisex.)</p>	<p><input type="checkbox"/> Yes <input checked="" type="checkbox"/> No</p>	 <p>Photo #003</p>	<ul style="list-style-type: none"> • Reconfigure toilet rooms 	
<p>3.2 Are there signs at inaccessible toilet rooms that give directions to accessible toilet rooms?</p>	<p><input type="checkbox"/> Yes <input checked="" type="checkbox"/> No</p>		<ul style="list-style-type: none"> • Install signs 	
<p>3.3 If not all toilet rooms are accessible, is there a sign at the accessible toilet room with the International Symbol of Accessibility?</p>	<p><input type="checkbox"/> Yes <input checked="" type="checkbox"/> No</p>		<ul style="list-style-type: none"> • Install sign 	

Accessible Route (2010 Standards – Chapter 4)			
<p>3.4 Is there a route to the accessible toilet room(s) that does not include the use of stairs?</p>	<p><input checked="" type="checkbox"/> Yes <input type="checkbox"/> No</p>		
<p>Is the route accessible? (See Priority 2 Interior Accessible Route for specifics.)</p>	<p><input type="checkbox"/> Yes <input type="checkbox"/> No</p>		

ADA Checklist for Readily Achievable Barrier Removal

Priority 4 – Additional Access

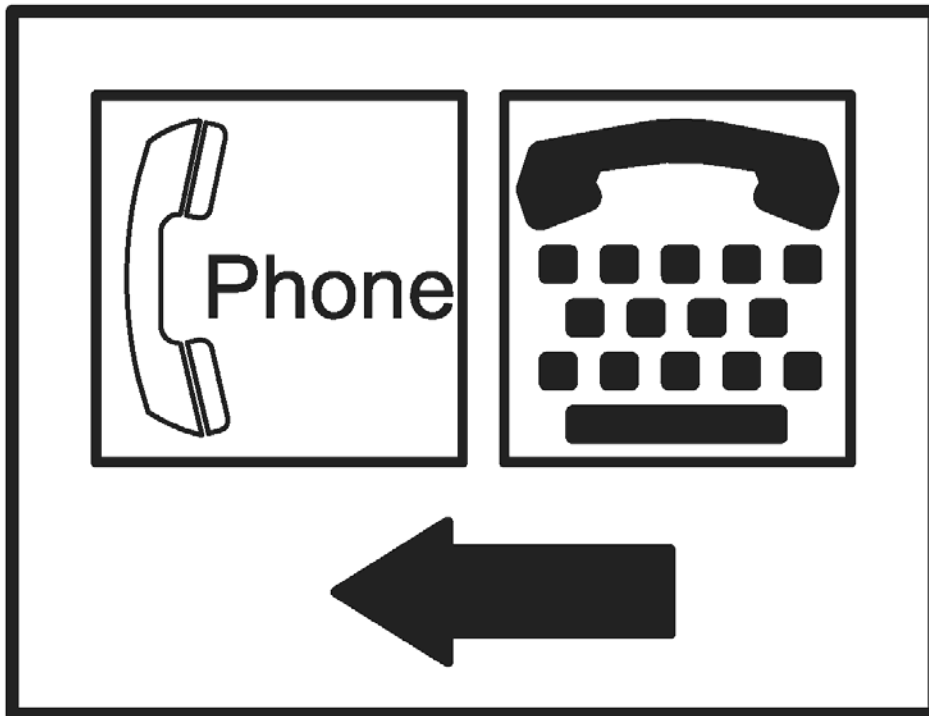

Project _____

Building _____

Location _____

Date _____

Surveyors _____

Contact Information _____

Amenities such as drinking fountains and public telephones should be accessible to people with disabilities.



Institute for Human Centered Design
www.HumanCenteredDesign.org
November 2011



ADA National Network
Questions on the ADA 800-949-4232 voice/tty
www.ADAchecklist.org

This checklist was produced by the New England ADA Center, a project of the Institute for Human Centered Design and a member of the ADA National Network. This checklist was developed under a grant from the Department of Education, NIDRR grant number H133A060092-09A. However the contents do not necessarily represent the policy of the Department of Education, and you should not assume endorsement by the Federal Government.

Questions or comments on the checklist contact the New England ADA Center at 617-695-0085 voice/tty or ADAinfo@NewEnglandADA.org

For the full set of checklists, including the checklists for recreation facilities visit www.ADAchecklist.org.

Priority 4 – Additional Access		Comments	Possible Solutions
Drinking Fountains (2010 Standards – 602)			
<p>4.1 Does at least one drinking fountain have a clear floor space at least 30 inches wide x at least 48 inches long centered in front of it for a forward approach?*</p>	<p><input type="checkbox"/> Yes <input checked="" type="checkbox"/> No</p> <p>Measurement:</p>	 <p>The diagram shows a top-down view of a drinking fountain. A dashed rectangle indicates a clear floor space in front of the fountain. The dimensions of this space are labeled as 48 inches (width) and 30 inches (length).</p>	<ul style="list-style-type: none"> • Install a drinking fountain in another location



Photo #001



Photo #002

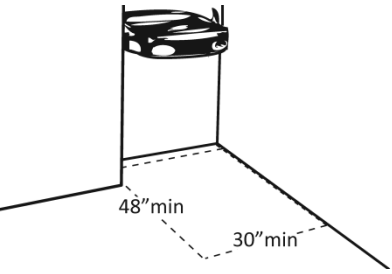
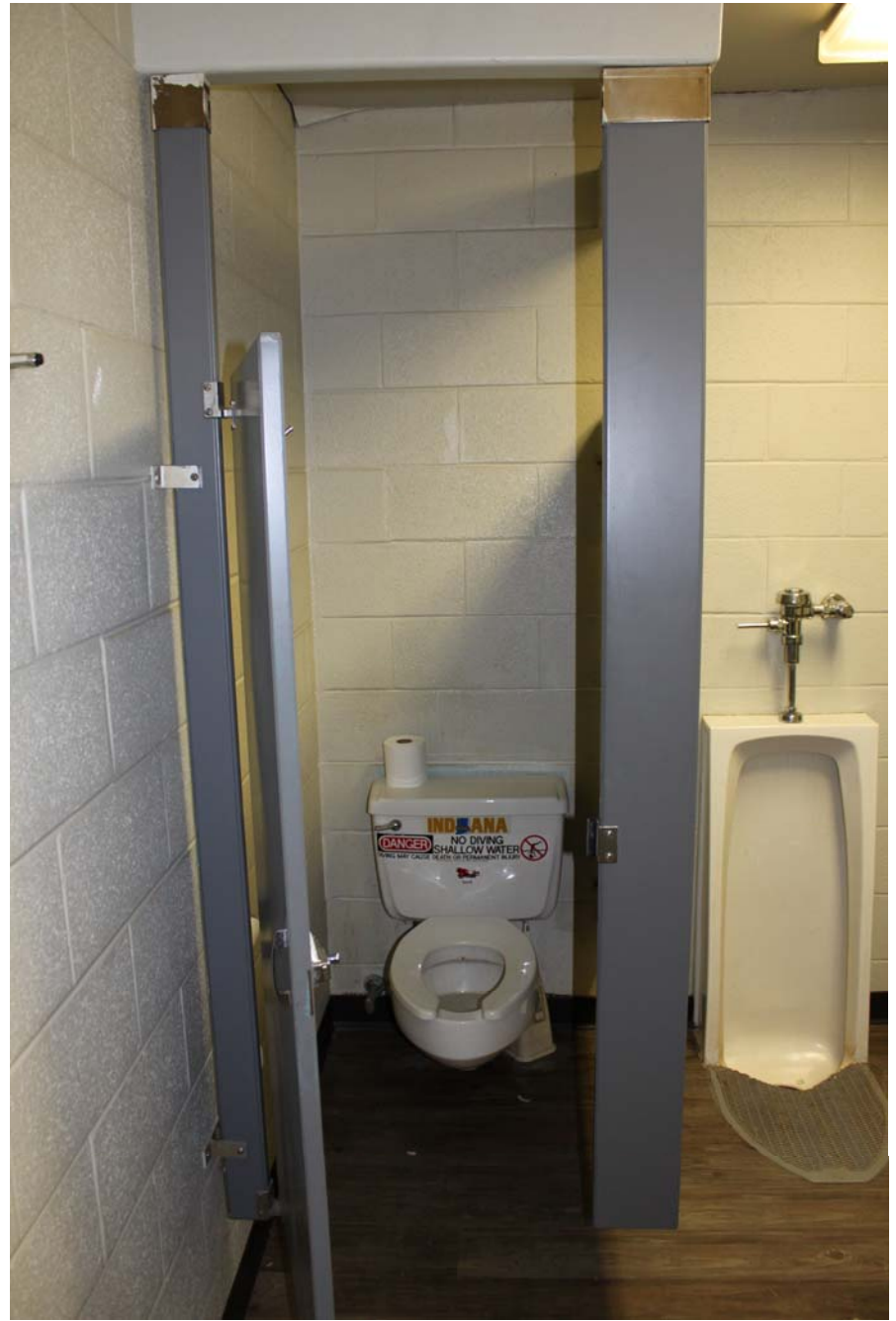

Photo #003

ADA Checklist for Readily Achievable Barrier Removal

Priority 1 – Approach & Entrance



Project Cass County ADA Transition Plan

Building EMA Building

Location Logansport, IN

Date 12/10/2012

Surveyors Henry Stellema & Dustin Schrougham

Contact Information 1-800-321-6959

An accessible route from site arrival points and an accessible entrance should be provided for everyone.



Institute for Human Centered Design
www.HumanCenteredDesign.org

November 2011



ADA National Network
Questions on the ADA 800-949-4232 voice/tty

www.ADAchecklist.org



This checklist was produced by the New England ADA Center, a project of the Institute for Human Centered Design and a member of the ADA National Network. This checklist was developed under a grant from the Department of Education, NIDRR grant number H133A060092-09A. However the contents do not necessarily represent the policy of the Department of Education, and you should not assume endorsement by the Federal Government.

Questions or comments on the checklist contact the New England ADA Center at 617-695-0085 voice/tty or ADAinfo@NewEnglandADA.org

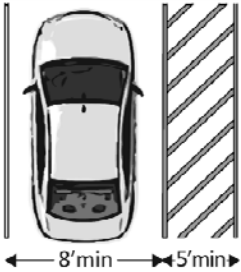
For the full set of checklists, including the checklists for recreation facilities visit www.ADAchecklist.org.

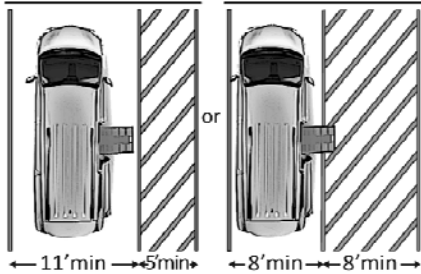
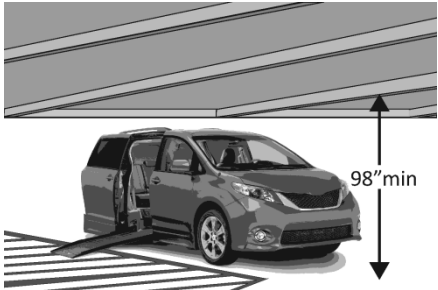
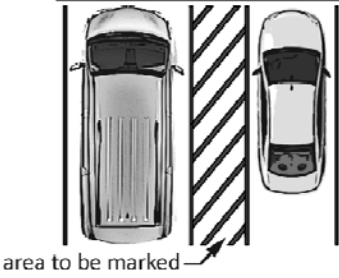

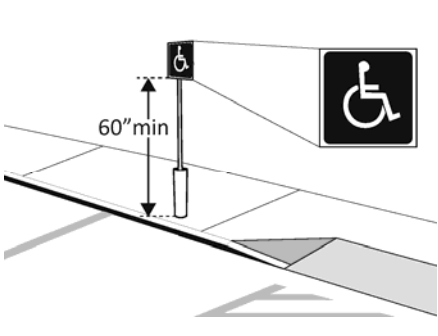
Priority 1 – Approach & Entrance		Comments	Possible Solutions												
<p>1.1 Is there at least one route from site arrival points (parking, passenger loading zones, public sidewalks and public transportation stops) that does not require the use of stairs?</p>	<p><input checked="" type="checkbox"/> Yes <input type="checkbox"/> No</p> <p>If yes, location of route:</p>														
<p>Parking (2010 Standards – 208 & 502) Note: Accessible parking spaces should be identified by size, access aisle and signage.</p>															
<p>1.2 If parking is provided for the public, are an adequate number of accessible spaces provided?</p>	<p><input checked="" type="checkbox"/> Yes <input type="checkbox"/> No</p> <p>Total #:10</p> <p>Accessible #: 1</p>	<table border="1"> <thead> <tr> <th>Total Spaces</th> <th>Accessible Spaces</th> </tr> </thead> <tbody> <tr> <td>1 - 25</td> <td>1</td> </tr> <tr> <td>26 - 50</td> <td>2</td> </tr> <tr> <td>51 - 75</td> <td>3</td> </tr> <tr> <td>76 - 100</td> <td>4</td> </tr> <tr> <td>100+ see 2010 Standards 208.2</td> <td></td> </tr> </tbody> </table>	Total Spaces	Accessible Spaces	1 - 25	1	26 - 50	2	51 - 75	3	76 - 100	4	100+ see 2010 Standards 208.2		
Total Spaces	Accessible Spaces														
1 - 25	1														
26 - 50	2														
51 - 75	3														
76 - 100	4														
100+ see 2010 Standards 208.2															
<p>1.3 Of the accessible spaces, is at least one a van accessible space?*</p>	<p><input type="checkbox"/> Yes <input checked="" type="checkbox"/> No</p>	<p>*For every 6 or fraction of 6 parking spaces required by the table above, at least 1 should be a van accessible space.</p>	 <p>Photo #001</p> <ul style="list-style-type: none"> • Reconfigure by repainting lines 												
<p>1.4 Are accessible spaces at least 8 feet wide with an access aisle at least 5 feet wide?</p>	<p><input checked="" type="checkbox"/> Yes <input type="checkbox"/> No</p> <p>Measurement:</p>														



<p>1.5 Is the van accessible space:</p> <p>At least 11 feet wide with an access aisle at least 5 feet wide? Or At least 8 feet wide with an access aisle at least 8 feet wide?</p>	<p><input type="checkbox"/> Yes <input checked="" type="checkbox"/> No</p> <p>Measurement:</p> <p><input type="checkbox"/> Yes <input checked="" type="checkbox"/> No</p> <p>Measurement:</p>			<ul style="list-style-type: none"> Reconfigure to provide van-accessible space(s)
<p>1.6 Is at least 98 inches of vertical clearance provided for the van accessible space?</p>	<p><input checked="" type="checkbox"/> Yes <input type="checkbox"/> No</p> <p>Measurement:</p>			
<p>1.7 Are the access aisles marked so as to discourage parking in them?</p>	<p><input type="checkbox"/> Yes <input checked="" type="checkbox"/> No</p> <p>Measurement:</p>			<ul style="list-style-type: none"> Mark access aisles <p>The marking method and color may be addressed by state/local requirements</p>
<p>1.8 Is the slope of the accessible parking spaces and access aisles no steeper than 1:48 in all directions?</p>	<p><input checked="" type="checkbox"/> Yes <input type="checkbox"/> No</p> <p>Measurement:</p>			

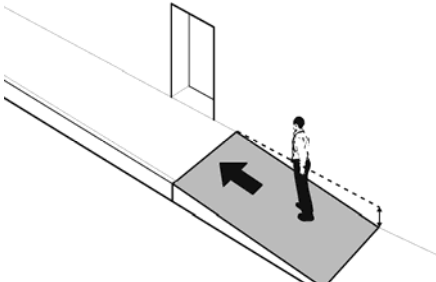
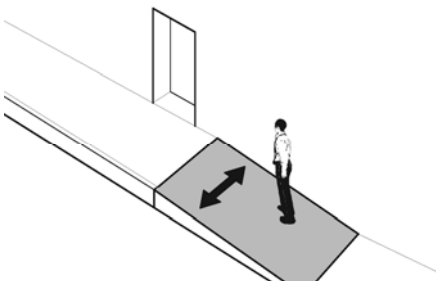
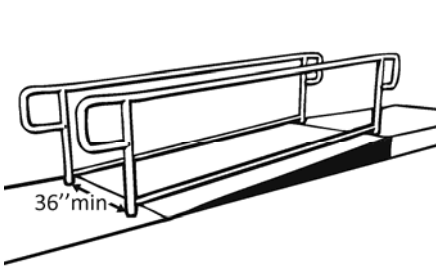

<p>1.9 Do the access aisles adjoin an accessible route?</p>	<p><input checked="" type="checkbox"/> Yes <input type="checkbox"/> No</p>		
<p>1.10 Are accessible spaces Identified with a sign that includes the International Symbol of Accessibility?</p> <p>Is the bottom of the sign at least 60 inches above the ground?</p>	<p><input checked="" type="checkbox"/> Yes <input type="checkbox"/> No</p> <p><input type="checkbox"/> Yes <input checked="" type="checkbox"/> No</p> <p>Measurement:</p>		<ul style="list-style-type: none"> • Install signs <p>The International Symbol of Accessibility is not required on the ground by the 2010 Standards</p>
<p>1.11 Are there signs reading “van accessible” at van accessible spaces?</p>	<p><input checked="" type="checkbox"/> Yes <input type="checkbox"/> No</p>		<ul style="list-style-type: none"> • Install signs
<p>1.12 Of the total parking spaces, are the accessible spaces located on the closest accessible route to the accessible entrance(s)?</p>	<p><input checked="" type="checkbox"/> Yes <input type="checkbox"/> No</p>		<ul style="list-style-type: none"> • Reconfigure spaces <p>If parking lot serves multiple entrances, accessible parking should be dispersed</p>

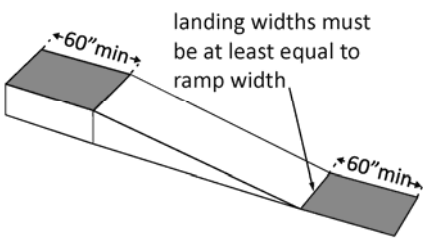

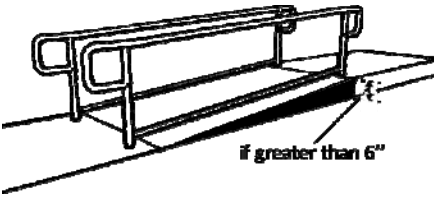
Exterior Accessible Route (2010 Standards – Ch.4)				
<p>1.13 Is the route stable, firm and slip-resistant?</p>	<p><input type="checkbox"/> Yes <input checked="" type="checkbox"/> No</p>			<ul style="list-style-type: none"> • Replace gravel with asphalt or other surface
<p>1.14 Is the route at least 36 inches wide?</p> <p>Note: The accessible route can narrow to 32 inches min. for a max. of 24 inches. These narrower portions of the route must be at least 48 inches from each other.</p>	<p><input checked="" type="checkbox"/> Yes <input type="checkbox"/> No</p> <p>Measurement:</p>	<p>The diagram illustrates two scenarios for wheelchair width. The top scenario shows a wheelchair on a flat surface with a vertical double-headed arrow indicating a minimum width of 36 inches. The bottom scenario shows a wheelchair on a narrow section of a path. Vertical double-headed arrows on either side indicate a minimum width of 32 inches. Horizontal double-headed arrows above the path indicate a maximum width of 24 inches for the narrow sections and a maximum of 48 inches between these narrow sections.</p>		
<p>1.15 If the route is greater than 200 feet in length and no less than 60 inches wide, is there a passing space no less than 60 x 60 inches?</p>	<p><input checked="" type="checkbox"/> Yes <input type="checkbox"/> No</p> <p>Measurement:</p>	<p>The diagram shows a rectangular passing space. A wheelchair is positioned at the top, and another is at the bottom. A vertical double-headed arrow on the left indicates a minimum height of 36 inches. A vertical double-headed arrow on the right indicates a minimum height of 60 inches. A horizontal double-headed arrow at the bottom indicates a maximum width of 60 inches.</p>		

<p>1.17 Is the running slope no steeper than 1:20, i.e. for every inch of height change there are at least 20 inches of route run?</p>	<p><input checked="" type="checkbox"/> Yes <input type="checkbox"/> No</p> <p>Measurement:</p>			
<p>1.18 Is the cross slope no steeper than 1:48?</p>	<p><input checked="" type="checkbox"/> Yes <input type="checkbox"/> No</p> <p>Measurement:</p>			
<p>Ramps (2010 Standards – 405 & 505) Note: If any portion of the accessible route is steeper than 1:20, it should be treated as a ramp.</p>				
<p>1.25 If there is a ramp (other than curb ramps), is it at least 36 inches wide? If there are handrails, measure between the handrails.</p>	<p><input checked="" type="checkbox"/> Yes <input type="checkbox"/> No</p> <p>Measurement:</p>			
<p>1.26 Is the surface stable, firm and slip resistant?</p>	<p><input checked="" type="checkbox"/> Yes <input type="checkbox"/> No</p>			

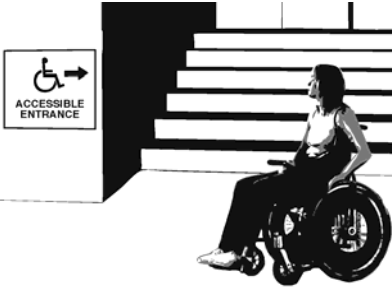
<p>1.27 For each section of the ramp, is the running slope no greater than 1:12, i.e. for every inch of height change there are at least 12 inches of ramp run?</p> <p>Note: Rises no greater than 3 inches with a slope no steeper than 1:8 and rises no greater than 6 inches with a slope no steeper than 1:10 are permitted when such slopes are necessary due to space limitations.</p>	<p><input type="checkbox"/> Yes <input checked="" type="checkbox"/> No</p> <p>Measurement:</p>		 <p>Photo #002</p>	<ul style="list-style-type: none"> • Lengthen ramp to decrease slope
<p>1.28 Is there a level landing that is at least 60 inches long and at least as wide as the ramp:</p> <p>At the top of the ramp?</p> <p>At the bottom of the ramp?</p>	<p><input type="checkbox"/> Yes <input checked="" type="checkbox"/> No</p> <p>Measurement:</p> <p><input type="checkbox"/> Yes <input checked="" type="checkbox"/> No</p> <p>Measurement:</p>			<ul style="list-style-type: none"> • Alter ramp

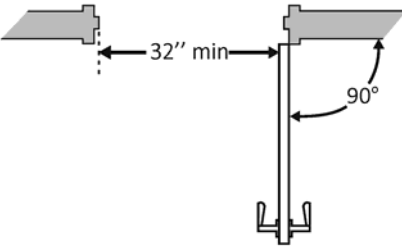
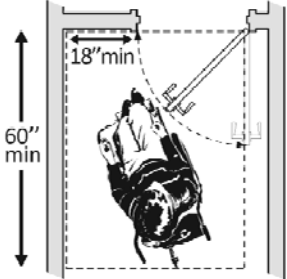
<p>1.30 If the ramp has a rise higher than 6 inches, are there handrails on both sides?</p>	<p><input type="checkbox"/> Yes <input checked="" type="checkbox"/> No</p> <p>Measurement:</p>			<ul style="list-style-type: none"> • Add handrails
<p>Entrance (2010 Standards – 404)</p>				
<p>1.37 Is the main entrance accessible?</p>	<p><input checked="" type="checkbox"/> Yes <input type="checkbox"/> No</p>			
<p>1.38 If the main entrance is not accessible, is there an alternative accessible entrance?</p> <p>Can the alternative accessible entrance be used independently and during the same hours as the main entrance?</p>	<p><input checked="" type="checkbox"/> Yes <input type="checkbox"/> No</p> <p><input checked="" type="checkbox"/> Yes <input type="checkbox"/> No</p>			

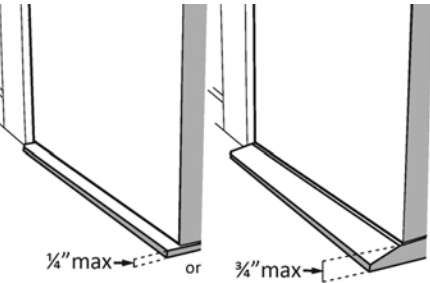
<p>1.39 Do all inaccessible entrances have signs indicating the location of the nearest accessible entrance?</p>	<p><input type="checkbox"/> Yes <input checked="" type="checkbox"/> No</p>		<ul style="list-style-type: none"> • Install signs
<p>1.40 If not all entrances are accessible, is there a sign at the accessible entrance with the International Symbol of Accessibility?</p>	<p><input type="checkbox"/> Yes <input checked="" type="checkbox"/> No</p>		<ul style="list-style-type: none"> • Install sign
<p>1.41 Is the clear opening width of the accessible entrance door at least 32 inches, between the face of the door and the stop, when the door is open 90 degrees?</p>	<p><input checked="" type="checkbox"/> Yes <input type="checkbox"/> No</p> <p>Measurement:</p>		
<p>1.42 If there is a front approach to the pull side of the door, is there at least 18 inches of maneuvering clearance beyond the latch side plus at least 60 inches clear depth?</p> <p>On both sides of the door, is the ground or floor surface of the maneuvering clearance level (no steeper than 1:48)?</p>	<p><input type="checkbox"/> Yes <input checked="" type="checkbox"/> No</p> <p>Measurement:</p> <p><input type="checkbox"/> Yes <input checked="" type="checkbox"/> No</p> <p>Measurement:</p>		<p>See 2010 Standards 404.2.4 for maneuvering clearance requirements on the push side of the door and side approaches to the pull side of the door</p>

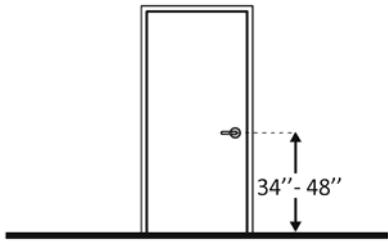
<p>1.43 Is the door threshold edge no more than ¼ inch high?</p> <p>Or</p> <p>No more than ¾ inch high if slope is beveled no steeper than 1:2?</p> <p>Note: The first ¼ inch of the threshold may be vertical; the rest must be beveled.</p>	<p><input checked="" type="checkbox"/> Yes <input type="checkbox"/> No</p> <p>Measurement:</p> <p><input checked="" type="checkbox"/> Yes <input type="checkbox"/> No</p> <p>Measurement:</p>			
<p>1.44 Is the door equipped with hardware, including locks, that is operable with one hand and does not require tight grasping, pinching, or twisting of the wrist?</p>	<p><input checked="" type="checkbox"/> Yes <input type="checkbox"/> No</p>			
<p>1.45 Are the operable parts of the door hardware no less than 34 inches and no greater than 48 inches above the floor or ground surface?</p>	<p><input checked="" type="checkbox"/> Yes <input type="checkbox"/> No</p> <p>Measurement:</p>			

ADA Checklist for Readily Achievable Barrier Removal

Priority 2 – Access to Goods & Services

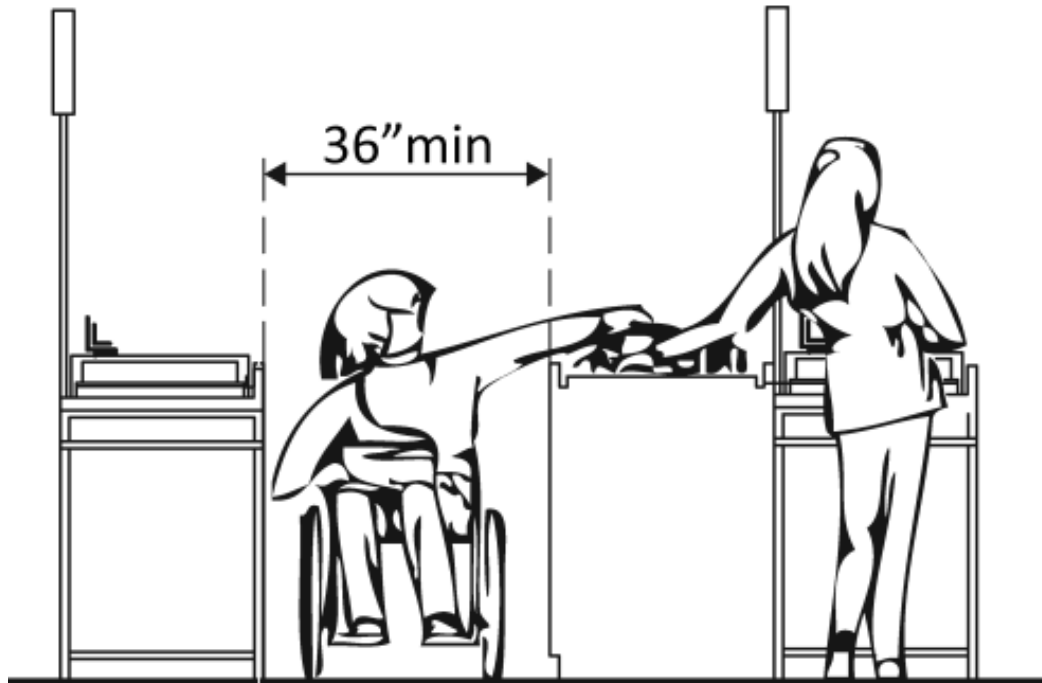

Project _____

Building _____

Location _____

Date _____

Surveyors _____

Contact Information _____

The layout of the building should allow people with disabilities to obtain goods and services and to participate in activities without assistance.



Institute for Human Centered Design
www.HumanCenteredDesign.org
November 2011





ADA National Network
Questions on the ADA 800-949-4232 voice/tty
www.ADAchecklist.org

This checklist was produced by the New England ADA Center, a project of the Institute for Human Centered Design and a member of the ADA National Network. This checklist was developed under a grant from the Department of Education, NIDRR grant number H133A060092-09A. However the contents do not necessarily represent the policy of the Department of Education, and you should not assume endorsement by the Federal Government.

Questions or comments on the checklist contact the New England ADA Center at 617-695-0085 voice/tty or ADAinfo@NewEnglandADA.org

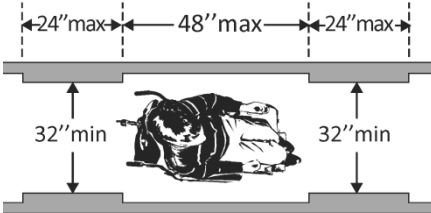
For the full set of checklists, including the checklists for recreation facilities visit www.ADAchecklist.org.

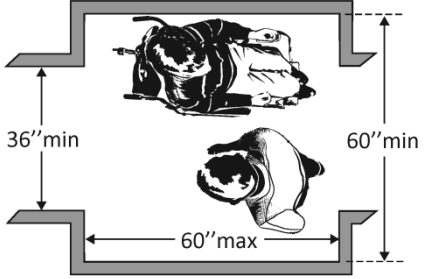
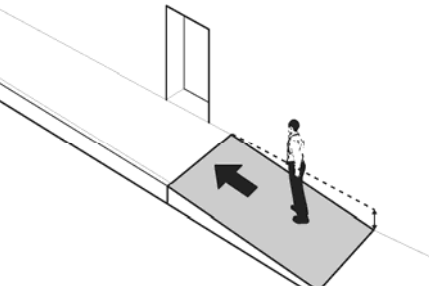
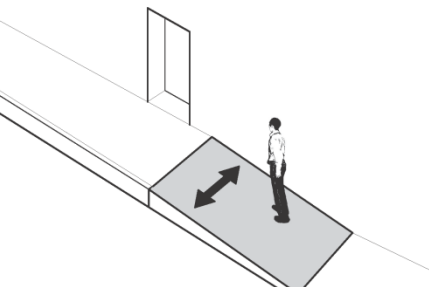
Priority 2 – Access to Goods & Services		Comments	Possible Solutions
<p>2.1 Does the accessible entrance provide direct access to the main floor, lobby and elevator?</p> <p><input checked="" type="checkbox"/> Yes <input type="checkbox"/> No</p>			
<p>Interior Accessible Route (2010 Standards – Ch.4)</p>			
<p>2.2 Are all public spaces on at least one accessible route?</p> <p><input checked="" type="checkbox"/> Yes <input type="checkbox"/> No</p>			
<p>2.3 Is the route stable, firm and slip-resistant?</p> <p><input checked="" type="checkbox"/> Yes <input type="checkbox"/> No</p>			
<p>2.4 Is the route at least 36 inches wide?</p> <p>Note: The accessible route can narrow to 32 inches min. for a max. of 24 inches. These narrower portions of the route must be at least 48 inches from each other.</p> <p>Measurement:</p>	 		

<p>2.5 If the route is greater than 200 feet in length and no less than 36 inches wide, is there a passing space no less than 60 x 60 inches?</p>	<p><input checked="" type="checkbox"/> Yes <input type="checkbox"/> No</p> <p>Measurement:</p>			
<p>2.6 Is the running slope no steeper than 1:20, i.e. for every inch of height change there are at least 20 inches of route run?</p>	<p><input checked="" type="checkbox"/> Yes <input type="checkbox"/> No</p> <p>Measurement:</p>			
<p>2.7 Is the cross slope no steeper than 1:48?</p>	<p><input checked="" type="checkbox"/> Yes <input type="checkbox"/> No</p> <p>Measurement:</p>			
<p>2.8 Do all objects on circulation paths through public areas, e.g. fire extinguishers, drinking fountains, signs, etc., protrude no more than 4 inches into the path? Or If an object protrudes more than 4 inches, is the bottom leading edge at 27 inches or lower above the floor?</p>	<p><input checked="" type="checkbox"/> Yes <input type="checkbox"/> No</p> <p>Measurement:</p> <p><input type="checkbox"/> Yes <input type="checkbox"/> No</p> <p>Measurement:</p>	 <p style="text-align: center;">Or</p>		

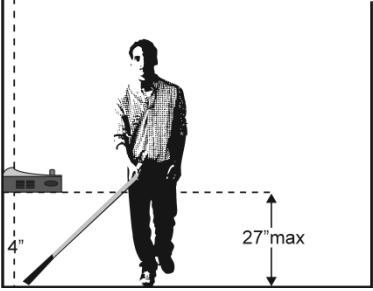
<p>Or Is the bottom leading edge at 80 inches or higher above the floor?</p>	<p><input type="checkbox"/> Yes <input type="checkbox"/> No Measurement:</p>	 <p>Or</p>		
----------------------------------------------------------------------------------	----------------------------------------------------------------------------------	----------------------------------------------------------------------------------------------	--	--

Ramps (2010 Standards 404 & 505)

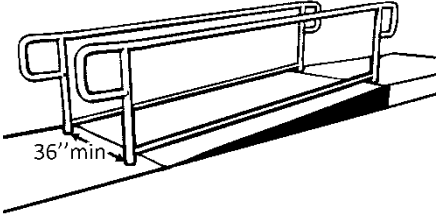
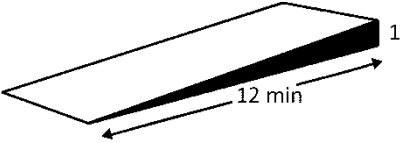
<p>2.10 If there is a ramp, is it at least 36 inches wide? If there are handrails, measure between the handrails.</p>	<p><input checked="" type="checkbox"/> Yes <input type="checkbox"/> No Measurement:</p>			
<p>2.11 Is the surface stable, firm and slip resistant?</p>	<p><input checked="" type="checkbox"/> Yes <input type="checkbox"/> No</p>			
<p>2.12 For each section of the ramp, is the running slope no greater than 1:12, i.e. for every inch of height change there are at least 12 inches of ramp run?</p>	<p><input checked="" type="checkbox"/> Yes <input type="checkbox"/> No Measurement:</p>			

2.13 Is there a level landing that is at least 60 inches long and at least as wide as the ramp:

At the top of the ramp?

Yes No

Measurement:

At the bottom of the ramp?

Yes No

Measurement:

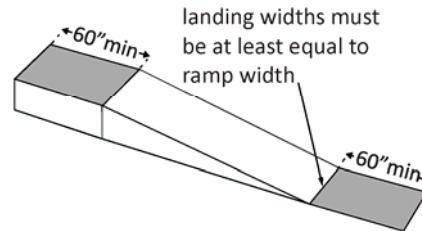

2.15 If the ramp has a rise higher than 6 inches are there handrails on both sides?

Yes No

Measurement:

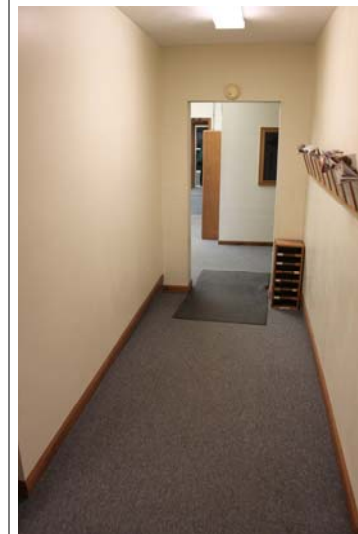
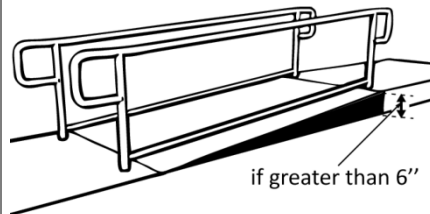
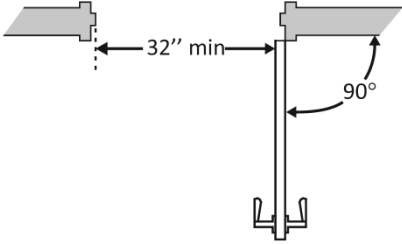
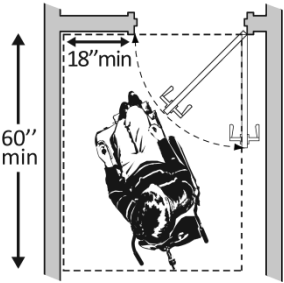
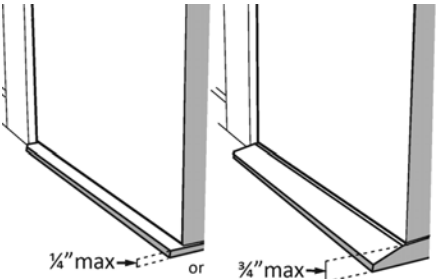
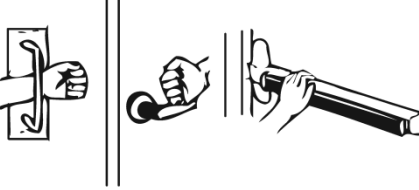
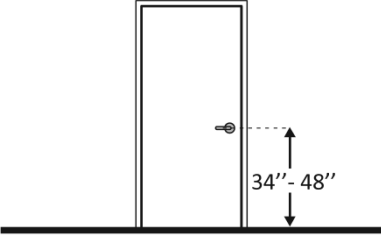
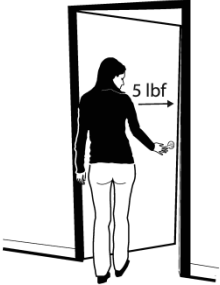
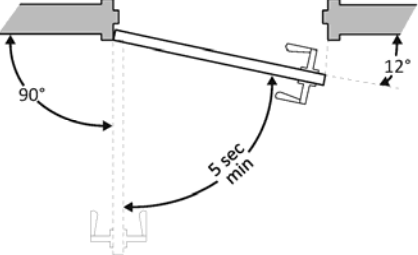

Photo #003

- Add handrails to ramp at assembly room

Interior Doors – to classrooms, medical exam rooms, conference rooms, etc. (2010 Standards – 404)				
<p>2.40 Is the door opening width at least 32 inches clear, between the face of the door and the stop, when the door is open 90 degrees?</p>	<p><input checked="" type="checkbox"/> Yes <input type="checkbox"/> No</p> <p>Measurement:</p>			
<p>2.41 If there is a front approach to the pull side of the door, is there at least 18 inches of maneuvering clearance beyond the latch side plus at least 60 inches clear depth?</p> <p>On both sides of the door, is the floor surface of the maneuvering clearance level (no steeper than 1:48)?</p>	<p><input type="checkbox"/> Yes <input checked="" type="checkbox"/> No</p> <p>Measurement:</p> <p><input type="checkbox"/> Yes <input type="checkbox"/> No</p> <p>Measurement:</p>		<p>Door to back storage area doesn't have maneuvering clearance.</p> <p>Photo #:</p>	<ul style="list-style-type: none"> • Remove obstructions • Reconfigure walls • Add automatic door opener <p>See 2010 Standards 404.2.4 for maneuvering clearance requirements on the push side of the door and side approaches to the pull side of the door</p>
<p>2.42 Is the door threshold edge no more than ¼ inch high?</p> <p>Or</p> <p>No more than ¾ inch high if slope is beveled no steeper than 1:2?</p> <p>Note: The first ¼ inch of the threshold may be vertical; the rest must be beveled.</p>	<p><input checked="" type="checkbox"/> Yes <input type="checkbox"/> No</p> <p>Measurement:</p> <p><input checked="" type="checkbox"/> Yes <input type="checkbox"/> No</p> <p>Measurement:</p>			

<p>2.43 Is the door equipped with hardware that is operable with one hand and does not require tight grasping, pinching and twisting of the wrist?</p>	<p><input type="checkbox"/> Yes <input checked="" type="checkbox"/> No</p>			<ul style="list-style-type: none"> • Replace inaccessible knob with lever, loop or push hardware
<p>2.44 Are the operable parts of the hardware no less than 34 inches and no greater than 48 inches above the floor?</p>	<p><input checked="" type="checkbox"/> Yes <input type="checkbox"/> No Measurement:</p>			
<p>2.45 Can the door be opened easily (5 pounds maximum force)?</p> <p>Note: You can use a pressure gauge or fish scale to measure force. If you do not have a pressure gauge or fish scale you will need to judge whether the door is easy to open.</p>	<p><input checked="" type="checkbox"/> Yes <input type="checkbox"/> No Measurement:</p>			
<p>2.46 If the door has a closer, does it take at least 5 seconds to close from an open position of 90 degrees to a position of 12 degrees from the latch?</p>	<p><input checked="" type="checkbox"/> Yes <input type="checkbox"/> No Measurement:</p>			

Controls – light switches, security and intercom systems, emergency/alarm boxes, etc. (2010 Standards – 309)

<p>2.50 Is there a clear floor space at least 30 inches wide by at least 48 inches long for a forward or parallel approach?</p> <p>Are the operable parts no higher than 48 inches above the floor?*</p>	<p><input checked="" type="checkbox"/> Yes <input type="checkbox"/> No</p> <p>Measurement:</p> <p><input checked="" type="checkbox"/> Yes <input type="checkbox"/> No</p> <p>Measurement:</p>			
-----------------------------------------------------------------------------------------------------------------------------------------------------------------------------------------------------------------	-----------------------------------------------------------------------------------------------------------------------------------------------------------------------------------------------	--	--	--

<p>2.51 Can the control be operated with one hand and without tight grasping, pinching, or twisting of the wrist?</p>	<p><input checked="" type="checkbox"/> Yes <input type="checkbox"/> No</p>			
------------------------------------------------------------------------------------------------------------------------------	----------------------------------------------------------------------------	--	--	--

Seating: General – reception areas, waiting rooms, etc. (2010 Standards – 801)

<p>2.68 Is there at least one space at least 36 inches wide by at least 48 inches long for a person in a wheelchair?</p>	<p><input checked="" type="checkbox"/> Yes <input type="checkbox"/> No</p> <p>Measurement:</p>			<ul style="list-style-type: none"> • Move furniture and equipment to provide space
---------------------------------------------------------------------------------------------------------------------------------	------------------------------------------------------------------------------------------------	--	--	---------------------------------------------------------------------------------------------------

The ADA Checklist for Readily Achievable Barrier Removal

Priority 3 - Toilet Rooms

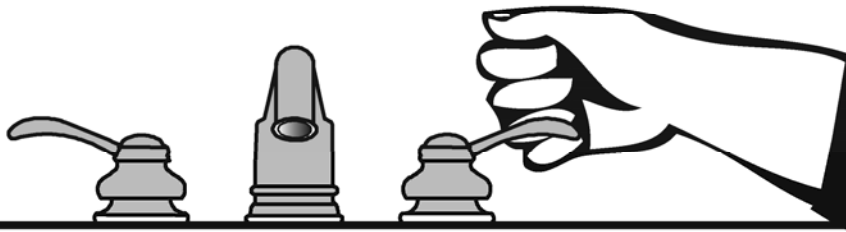

Project

Building

Location

Date

Surveyors

Contact Information

When toilet rooms are open to the public they should be accessible to people with disabilities.



Institute for Human Centered Design
www.HumanCenteredDesign.org
November 2011



ADA National Network
Questions on the ADA 800-949-4232 voice/tty
www.ADAchecklist.org

This checklist was produced by the New England ADA Center, a project of the Institute for Human Centered Design and a member of the ADA National Network. This checklist was developed under a grant from the Department of Education, NIDRR grant number H133A060092-09A. However the contents do not necessarily represent the policy of the Department of Education, and you should not assume endorsement by the Federal Government.

Questions or comments on the checklist contact the New England ADA Center at 617-695-0085 voice/tty or ADAinfo@NewEnglandADA.org

For the full set of checklists, including the checklists for recreation facilities visit www.ADAchecklist.org.

Priority 3 – Toilet Rooms			Comments	Possible Solutions
3.1 If toilet rooms are available to the public, is at least one toilet room accessible? (Either one for each sex, or one unisex.)	<input type="checkbox"/> Yes <input checked="" type="checkbox"/> No		Toilet is entirely non-compliant.	<ul style="list-style-type: none"> • Reconfigure toilet rooms • Combine toilet rooms to create one unisex accessible toilet room



Photo #001



Photo #002

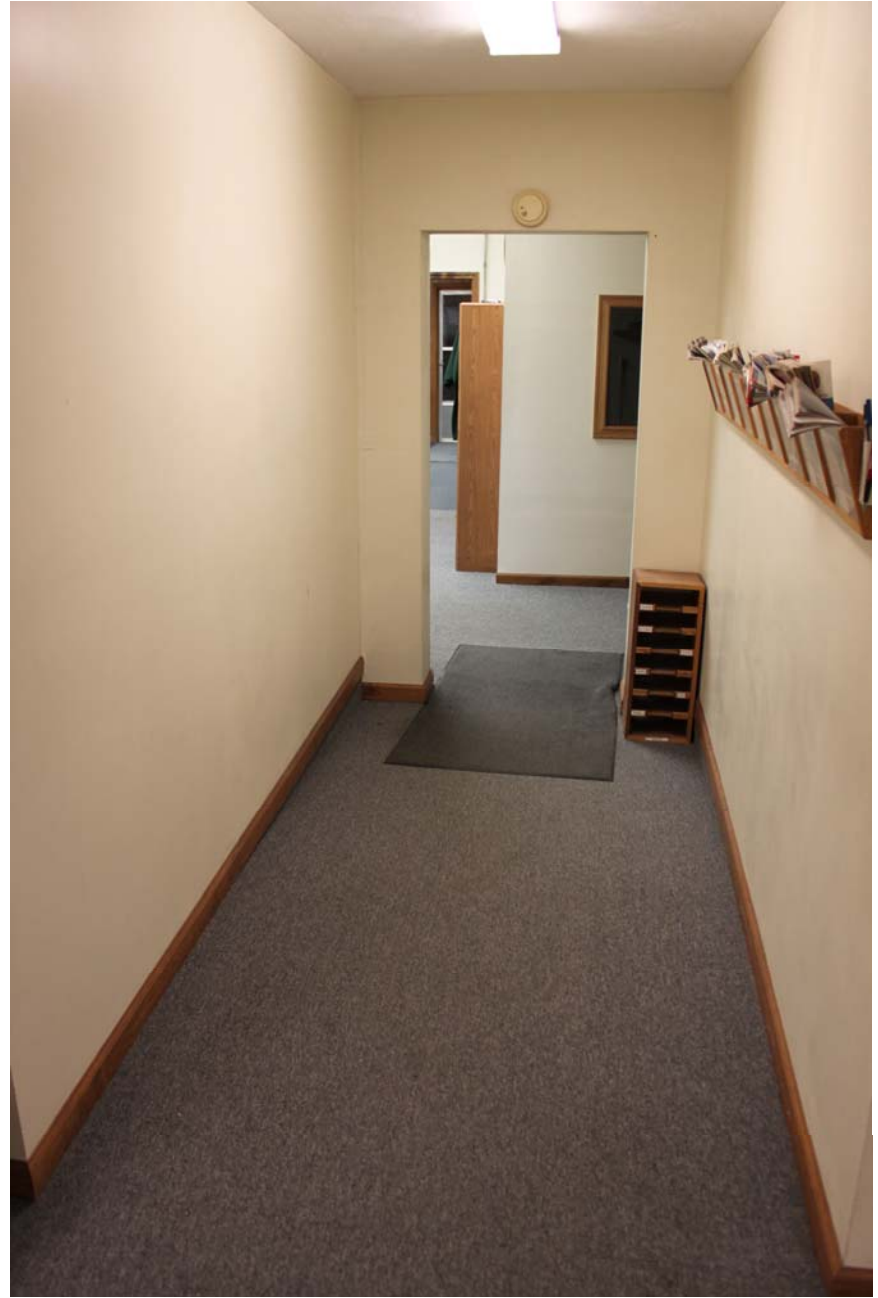
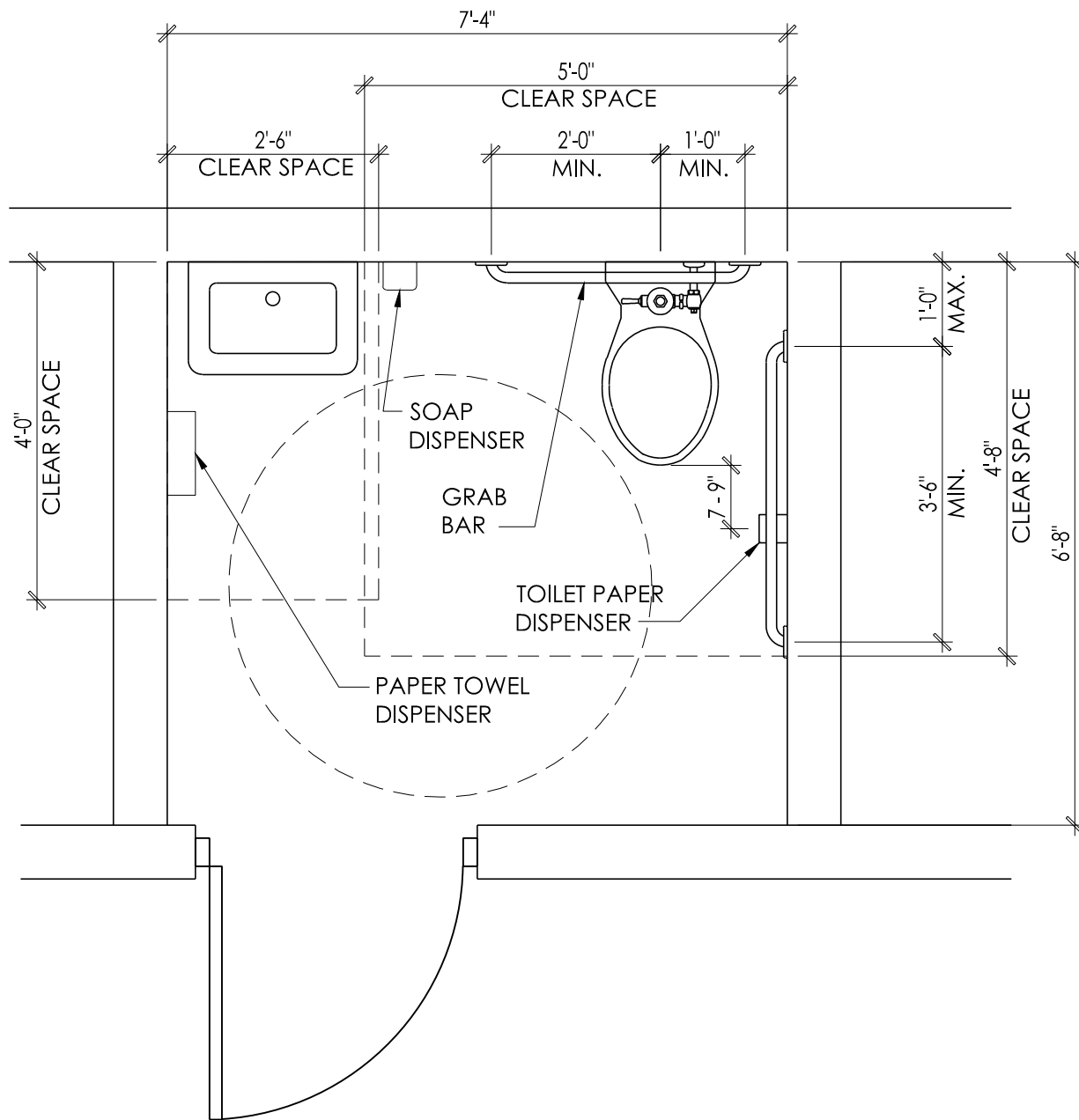
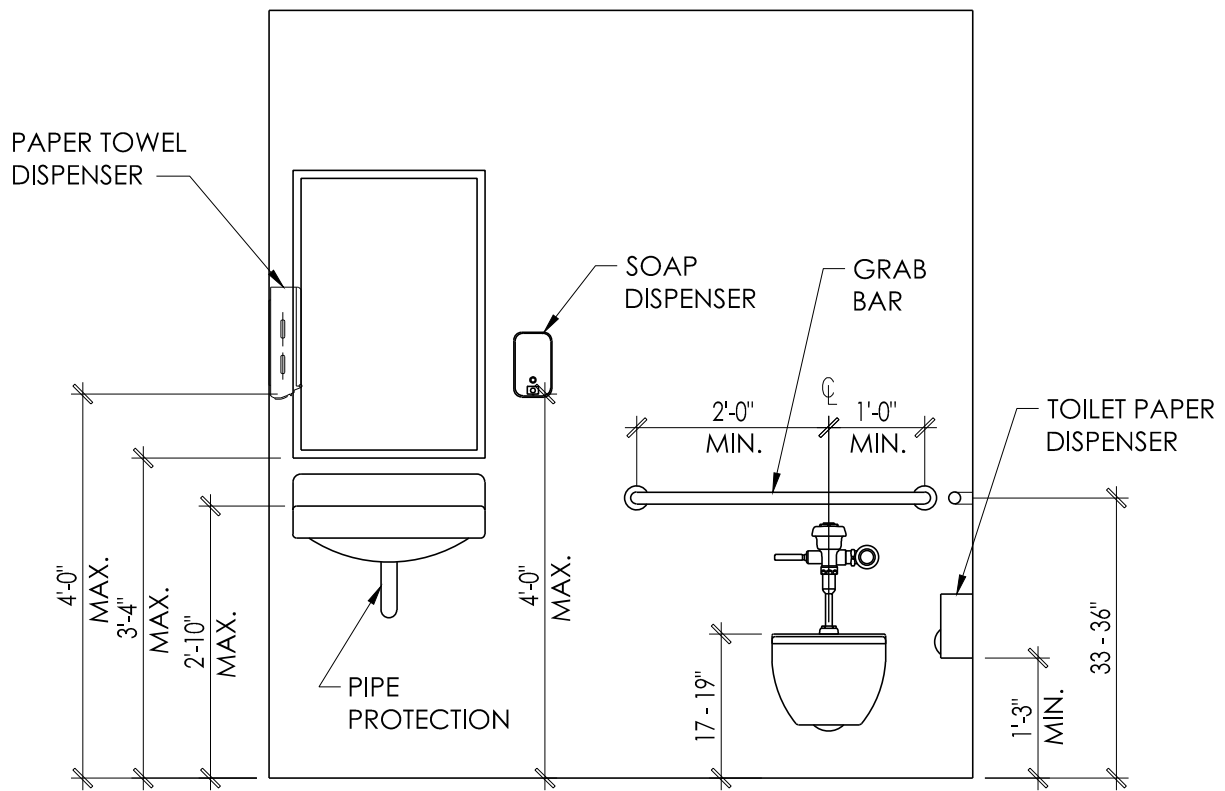

Photo #003



SKETCH #001 - TYPICAL ACCESSIBLE TOILET PLAN



SKETCH #002 - TYPICAL ACCESSIBLE TOILET
 ELEVATION

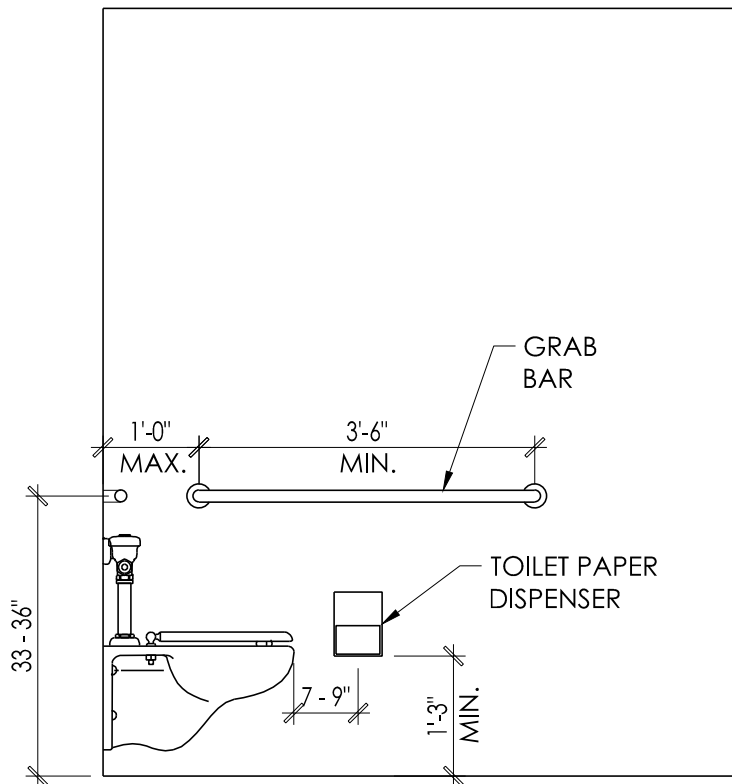

SKETCH #003 - TYPICAL ACCESSIBLE TOILET
ELEVATION

ADA Checklist for Readily Achievable Barrier Removal

Priority 1 – Approach & Entrance



Project **Cass County ADA Transition Plan**

Building **Cass County Annex**

Location **Logansport, IN**

Date **12/10/2012**

Surveyors **Henry Stellema & Dustin Schrougham**

Contact Information **1-800-321-6959**

An accessible route from site arrival points and an accessible entrance should be provided for everyone.



Institute for Human Centered Design
www.HumanCenteredDesign.org

November 2011





ADA National Network
Questions on the ADA 800-949-4232 voice/tty

www.ADAchecklist.org



This checklist was produced by the New England ADA Center, a project of the Institute for Human Centered Design and a member of the ADA National Network. This checklist was developed under a grant from the Department of Education, NIDRR grant number H133A060092-09A. However the contents do not necessarily represent the policy of the Department of Education, and you should not assume endorsement by the Federal Government.

Questions or comments on the checklist contact the New England ADA Center at 617-695-0085 voice/tty or ADAinfo@NewEnglandADA.org

For the full set of checklists, including the checklists for recreation facilities visit www.ADAchecklist.org.

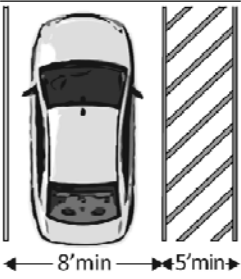
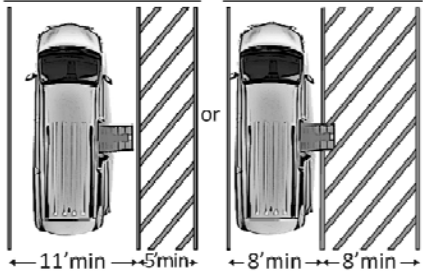
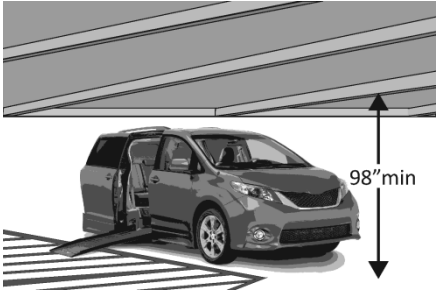
Priority 1 – Approach & Entrance		Comments	Possible Solutions													
<p>1.1 Is there at least one route from site arrival points (parking, passenger loading zones, public sidewalks and public transportation stops) that does not require the use of stairs?</p>	<p><input checked="" type="checkbox"/> Yes <input type="checkbox"/> No</p> <p>If yes, location of route:</p>															
<p>Parking (2010 Standards – 208 & 502) Note: Accessible parking spaces should be identified by size, access aisle and signage.</p>																
<p>1.2 If parking is provided for the public, are an adequate number of accessible spaces provided?</p>	<p><input type="checkbox"/> Yes <input checked="" type="checkbox"/> No</p> <p>Total #:52</p> <p>Accessible #: 0</p>	<table border="1"> <thead> <tr> <th>Total Spaces</th> <th>Accessible Spaces</th> </tr> </thead> <tbody> <tr> <td>1 - 25</td> <td>1</td> </tr> <tr> <td>26 - 50</td> <td>2</td> </tr> <tr> <td>51 - 75</td> <td>3</td> </tr> <tr> <td>76 - 100</td> <td>4</td> </tr> <tr> <td colspan="2">100+ see 2010 Standards 208.2</td> </tr> </tbody> </table>	Total Spaces	Accessible Spaces	1 - 25	1	26 - 50	2	51 - 75	3	76 - 100	4	100+ see 2010 Standards 208.2		 <p>Photo #001</p>  <p>Photo #002</p>  <p>Photo #003</p>	<ul style="list-style-type: none"> • Reconfigure by repainting lines
Total Spaces	Accessible Spaces															
1 - 25	1															
26 - 50	2															
51 - 75	3															
76 - 100	4															
100+ see 2010 Standards 208.2																

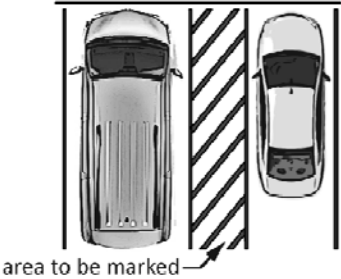
<p>1.3 Of the accessible spaces, is at least one a van accessible space?*</p>	<p><input type="checkbox"/> Yes <input checked="" type="checkbox"/> No</p>	<p>*For every 6 or fraction of 6 parking spaces required by the table above, at least 1 should be a van accessible space.</p>		<ul style="list-style-type: none"> • Reconfigure by repainting lines
<p>1.4 Are accessible spaces at least 8 feet wide with an access aisle at least 5 feet wide?</p>	<p><input type="checkbox"/> Yes <input checked="" type="checkbox"/> No</p> <p>Measurement:</p>			<ul style="list-style-type: none"> • Reconfigure by repainting lines <p>Two spaces can share an access aisle (check state requirements; some states, such as Connecticut, require an access aisle for each space)</p>
<p>1.5 Is the van accessible space:</p> <p>At least 11 feet wide with an access aisle at least 5 feet wide?</p> <p>Or</p> <p>At least 8 feet wide with an access aisle at least 8 feet wide?</p>	<p><input type="checkbox"/> Yes <input checked="" type="checkbox"/> No</p> <p>Measurement:</p> <p><input type="checkbox"/> Yes <input checked="" type="checkbox"/> No</p> <p>Measurement:</p>			<ul style="list-style-type: none"> • Reconfigure to provide van-accessible space(s)
<p>1.6 Is at least 98 inches of vertical clearance provided for the van accessible space?</p>	<p><input checked="" type="checkbox"/> Yes <input type="checkbox"/> No</p> <p>Measurement:</p>			

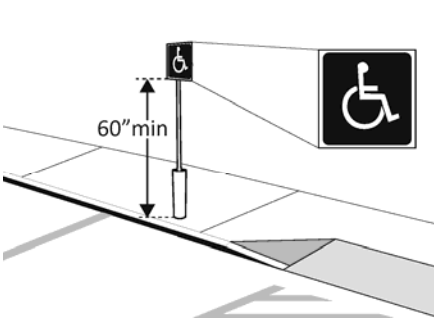
<p>1.7 Are the access aisles marked so as to discourage parking in them?</p>	<p><input type="checkbox"/> Yes <input checked="" type="checkbox"/> No</p>		<ul style="list-style-type: none"> • Mark access aisles <p>The marking method and color may be addressed by state/local requirements</p>
<p>1.8 Is the slope of the accessible parking spaces and access aisles no steeper than 1:48 in all directions?</p>	<p><input checked="" type="checkbox"/> Yes <input type="checkbox"/> No</p> <p>Measurement:</p>		
<p>1.9 Do the access aisles adjoin an accessible route?</p>	<p><input checked="" type="checkbox"/> Yes <input type="checkbox"/> No</p>		
<p>1.10 Are accessible spaces Identified with a sign that includes the International Symbol of Accessibility?</p> <p>Is the bottom of the sign at least 60 inches above the ground?</p>	<p><input type="checkbox"/> Yes <input checked="" type="checkbox"/> No</p> <p><input type="checkbox"/> Yes <input checked="" type="checkbox"/> No</p> <p>Measurement:</p>		<ul style="list-style-type: none"> • Install signs <p>The International Symbol of Accessibility is not required on the ground by the 2010 Standards</p>

<p>1.11 Are there signs reading “van accessible” at van accessible spaces?</p>	<p><input type="checkbox"/> Yes <input checked="" type="checkbox"/> No</p>		<ul style="list-style-type: none"> • Install signs
<p>1.12 Of the total parking spaces, are the accessible spaces located on the closest accessible route to the accessible entrance(s)?</p>	<p><input type="checkbox"/> Yes <input checked="" type="checkbox"/> No</p>		<ul style="list-style-type: none"> • Reconfigure spaces <p>If parking lot serves multiple entrances, accessible parking should be dispersed</p>

Exterior Accessible Route (2010 Standards – Ch.4)

<p>1.13 Is the route stable, firm and slip-resistant?</p>	<p><input checked="" type="checkbox"/> Yes <input type="checkbox"/> No</p>		
<p>1.14 Is the route at least 36 inches wide?</p> <p>Note: The accessible route can narrow to 32 inches min. for a max. of 24 inches. These narrower portions of the route must be at least 48 inches from each other.</p>	<p><input checked="" type="checkbox"/> Yes <input type="checkbox"/> No</p> <p>Measurement:</p>		

<p>1.15 If the route is greater than 200 feet in length and no less than 60 inches wide, is there a passing space no less than 60 x 60 inches?</p>	<p><input checked="" type="checkbox"/> Yes <input type="checkbox"/> No Measurement:</p>			
<p>1.17 Is the running slope no steeper than 1:20, i.e. for every inch of height change there are at least 20 inches of route run?</p>	<p><input checked="" type="checkbox"/> Yes <input type="checkbox"/> No Measurement:</p>			
<p>1.18 Is the cross slope no steeper than 1:48?</p>	<p><input checked="" type="checkbox"/> Yes <input type="checkbox"/> No Measurement:</p>			



Photo #001



Photo #002



Photo #003

ADA Checklist for Readily Achievable Barrier Removal

Priority 1 – Approach & Entrance



Project Cass Count ADA Transition Plan

Building Cass County Annex - Novia Clinic

Location Logansport, IN

Date 12/10/2012

Surveyors Henry Stellema & Dustin Schrougham

Contact Information 1-800-321-6959

An accessible route from site arrival points and an accessible entrance should be provided for everyone.



Institute for Human Centered Design
www.HumanCenteredDesign.org

November 2011





ADA National Network
Questions on the ADA 800-949-4232 voice/tty

www.ADAchecklist.org

This checklist was produced by the New England ADA Center, a project of the Institute for Human Centered Design and a member of the ADA National Network. This checklist was developed under a grant from the Department of Education, NIDRR grant number H133A060092-09A. However the contents do not necessarily represent the policy of the Department of Education, and you should not assume endorsement by the Federal Government.

Questions or comments on the checklist contact the New England ADA Center at 617-695-0085 voice/tty or ADAinfo@NewEnglandADA.org

For the full set of checklists, including the checklists for recreation facilities visit www.ADAchecklist.org.

Priority 1 – Approach & Entrance		Comments	Possible Solutions
Entrance (2010 Standards – 404)			
<p>1.37 Is the main entrance accessible?</p> <p><input type="checkbox"/> Yes <input checked="" type="checkbox"/> No</p>			<ul style="list-style-type: none"> • Redesign to make it accessible
<p>1.38 If the main entrance is not accessible, is there an alternative accessible entrance?</p> <p>Can the alternative accessible entrance be used independently and during the same hours as the main entrance?</p> <p><input type="checkbox"/> Yes <input checked="" type="checkbox"/> No</p>			<ul style="list-style-type: none"> • Designate an entrance and make it accessible
<p>1.39 Do all inaccessible entrances have signs indicating the location of the nearest accessible entrance?</p> <p><input type="checkbox"/> Yes <input checked="" type="checkbox"/> No</p>			<ul style="list-style-type: none"> • Install signs

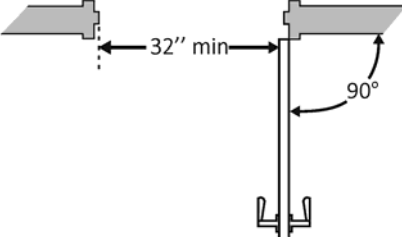
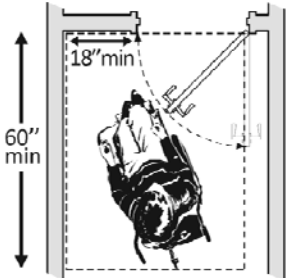
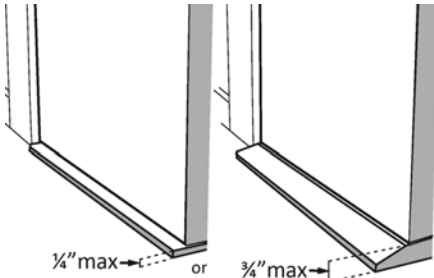
<p>1.40 If not all entrances are accessible, is there a sign at the accessible entrance with the International Symbol of Accessibility?</p>	<p><input type="checkbox"/> Yes <input checked="" type="checkbox"/> No</p>		<ul style="list-style-type: none"> • Install sign
<p>1.41 Is the clear opening width of the accessible entrance door at least 32 inches, between the face of the door and the stop, when the door is open 90 degrees?</p>	<p><input checked="" type="checkbox"/> Yes <input type="checkbox"/> No</p> <p>Measurement:</p>		
<p>1.42 If there is a front approach to the pull side of the door, is there at least 18 inches of maneuvering clearance beyond the latch side plus at least 60 inches clear depth?</p> <p>On both sides of the door, is the ground or floor surface of the maneuvering clearance level (no steeper than 1:48)?</p>	<p><input checked="" type="checkbox"/> Yes <input type="checkbox"/> No</p> <p>Measurement:</p> <p><input type="checkbox"/> Yes <input checked="" type="checkbox"/> No</p> <p>Measurement:</p>		<ul style="list-style-type: none"> • Make floor surface level
<p>1.43 Is the door threshold edge no more than ¼ inch high?</p> <p>Or</p> <p>No more than ¾ inch high if slope is beveled no steeper than 1:2?</p>	<p><input checked="" type="checkbox"/> Yes <input type="checkbox"/> No</p> <p>Measurement:</p> <p><input checked="" type="checkbox"/> Yes <input type="checkbox"/> No</p> <p>Measurement:</p>		

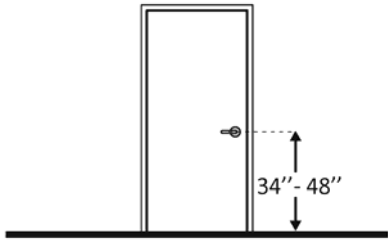
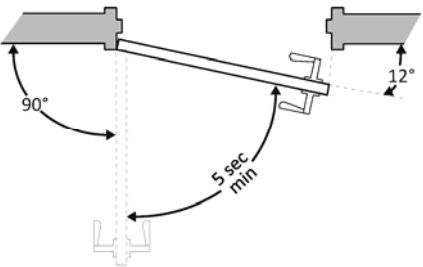
<p>Note: The first ¼ inch of the threshold may be vertical; the rest must be beveled.</p>				
<p>1.44 Is the door equipped with hardware, including locks, that is operable with one hand and does not require tight grasping, pinching, or twisting of the wrist?</p>	<p><input type="checkbox"/> Yes <input checked="" type="checkbox"/> No</p>			<ul style="list-style-type: none"> • Replace inaccessible hardware with lever, loop or push hardware
<p>1.45 Are the operable parts of the door hardware no less than 34 inches and no greater than 48 inches above the floor or ground surface?</p>	<p><input checked="" type="checkbox"/> Yes <input type="checkbox"/> No Measurement:</p>			
<p>1.46 If the door has a closer, does it take at least 5 seconds to close from an open position of 90 degrees to a position of 12 degrees from the latch?</p>	<p><input checked="" type="checkbox"/> Yes <input type="checkbox"/> No Measurement:</p>			

ADA Checklist for Readily Achievable Barrier Removal

Priority 2 – Access to Goods & Services

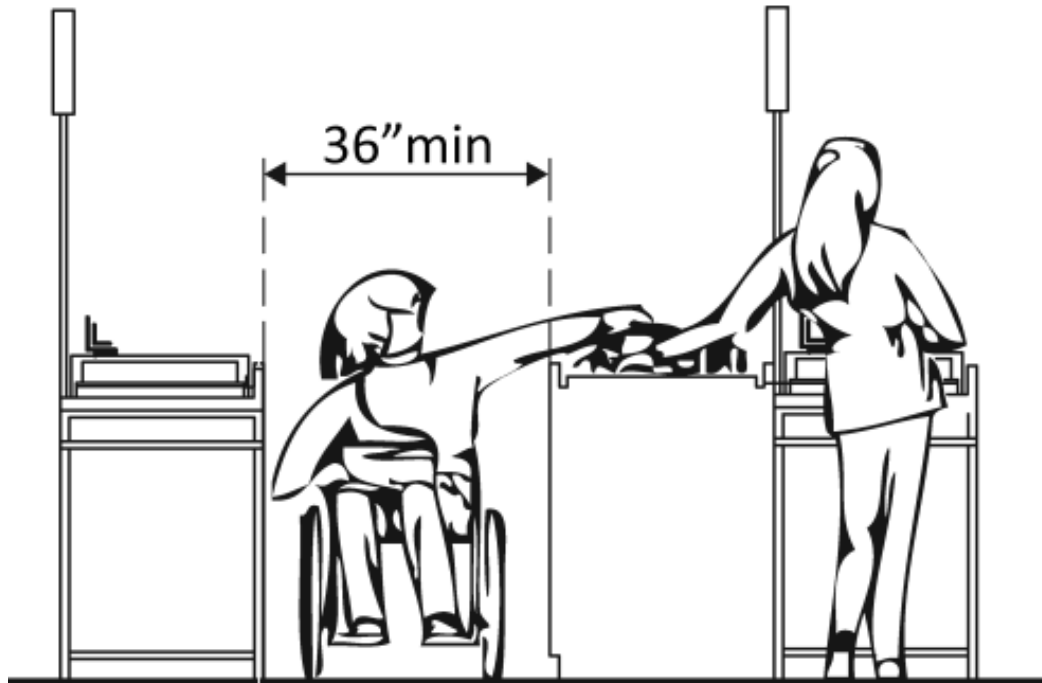

Project _____

Building _____

Location _____

Date _____

Surveyors _____

Contact Information _____

The layout of the building should allow people with disabilities to obtain goods and services and to participate in activities without assistance.



Institute for Human Centered Design
www.HumanCenteredDesign.org
November 2011







ADA National Network
Questions on the ADA 800-949-4232 voice/tty
www.ADAchecklist.org

This checklist was produced by the New England ADA Center, a project of the Institute for Human Centered Design and a member of the ADA National Network. This checklist was developed under a grant from the Department of Education, NIDRR grant number H133A060092-09A. However the contents do not necessarily represent the policy of the Department of Education, and you should not assume endorsement by the Federal Government.

Questions or comments on the checklist contact the New England ADA Center at 617-695-0085 voice/tty or ADAinfo@NewEnglandADA.org

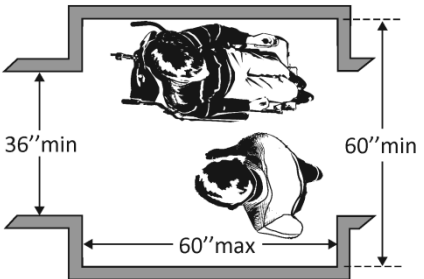
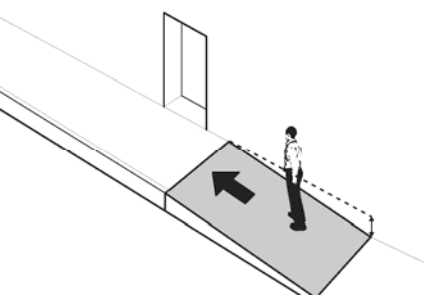
For the full set of checklists, including the checklists for recreation facilities visit www.ADAchecklist.org.

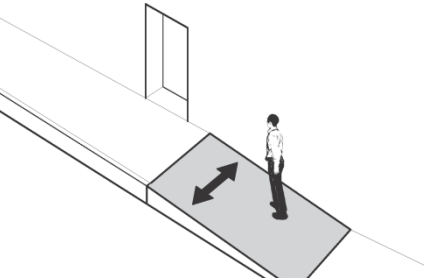
Priority 2 – Access to Goods & Services		Comments	Possible Solutions
2.1	Does the accessible entrance provide direct access to the main floor, lobby and elevator? <input checked="" type="checkbox"/> Yes <input type="checkbox"/> No		
Interior Accessible Route (2010 Standards – Ch.4)			
2.2	Are all public spaces on at least one accessible route? <input checked="" type="checkbox"/> Yes <input type="checkbox"/> No		
2.3	Is the route stable, firm and slip-resistant? <input checked="" type="checkbox"/> Yes <input type="checkbox"/> No		
2.4	Is the route at least 36 inches wide? Note: The accessible route can narrow to 32 inches min. for a max. of 24 inches. These narrower portions of the route must be at least 48 inches from each other.	<p>Measurement:</p>	

<p>2.5 If the route is greater than 200 feet in length and no less than 36 inches wide, is there a passing space no less than 60 x 60 inches?</p>	<p><input checked="" type="checkbox"/> Yes <input type="checkbox"/> No Measurement:</p>			
<p>2.6 Is the running slope no steeper than 1:20, i.e. for every inch of height change there are at least 20 inches of route run?</p>	<p><input type="checkbox"/> Yes <input checked="" type="checkbox"/> No Measurement:</p>		 <p>Photo #001</p>	<ul style="list-style-type: none"> • Redesign entry
<p>2.7 Is the cross slope no steeper than 1:48?</p>	<p><input checked="" type="checkbox"/> Yes <input type="checkbox"/> No Measurement:</p>			
<p>2.8 Do all objects on circulation paths through public areas, e.g. fire extinguishers, drinking fountains, signs, etc., protrude no more than 4 inches into the path? Or If an object protrudes more than 4 inches, is the bottom leading edge at 27 inches or</p>	<p><input checked="" type="checkbox"/> Yes <input type="checkbox"/> No Measurement: <input type="checkbox"/> Yes <input type="checkbox"/> No Measurement:</p>			

lower above the floor?
 Or
 Is the bottom leading edge at
 80 inches or higher above the
 floor?

Yes No

Measurement:

Or

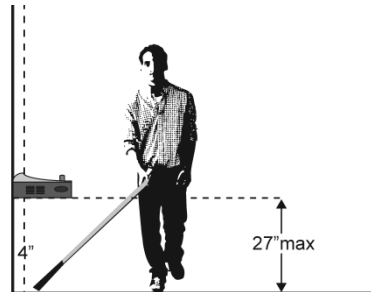

Or

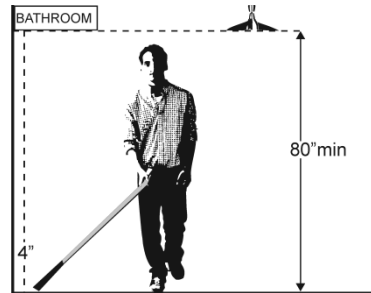



Interior Doors – to classrooms, medical exam rooms, conference rooms, etc. (2010 Standards – 404)

2.40 Is the door opening width at
 least 32 inches clear,
 between the face of the door
 and the stop, when the door
 is open 90 degrees?

Yes No

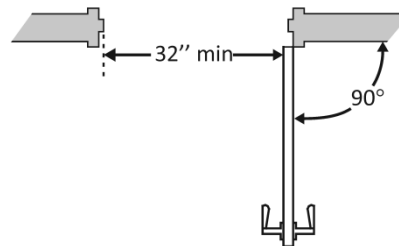
Measurement:

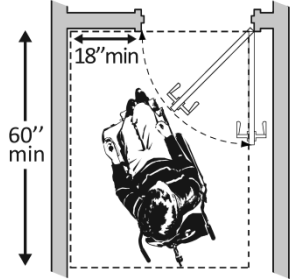

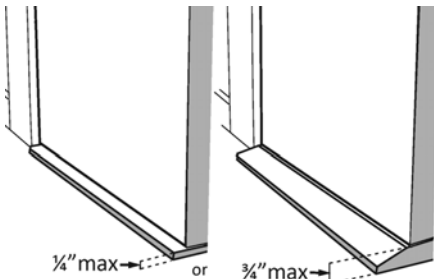
<p>2.41 If there is a front approach to the pull side of the door, is there at least 18 inches of maneuvering clearance beyond the latch side plus at least 60 inches clear depth?</p> <p>On both sides of the door, is the floor surface of the maneuvering clearance level (no steeper than 1:48)?</p>	<p><input type="checkbox"/> Yes <input checked="" type="checkbox"/> No</p> <p>Measurement:</p> <p><input type="checkbox"/> Yes <input type="checkbox"/> No</p> <p>Measurement:</p>		<p>At main corridor door, the 12" minimum on the push side of the door is not provided.</p>  <p>Photo #002</p>	<ul style="list-style-type: none"> • Reconfigure walls
<p>2.42 Is the door threshold edge no more than ¼ inch high?</p> <p>Or</p> <p>No more than ¾ inch high if slope is beveled no steeper than 1:2?</p> <p>Note: The first ¼ inch of the threshold may be vertical; the rest must be beveled.</p>	<p><input checked="" type="checkbox"/> Yes <input type="checkbox"/> No</p> <p>Measurement:</p> <p><input checked="" type="checkbox"/> Yes <input type="checkbox"/> No</p> <p>Measurement:</p>			

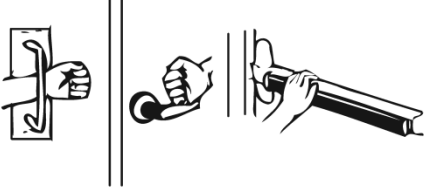
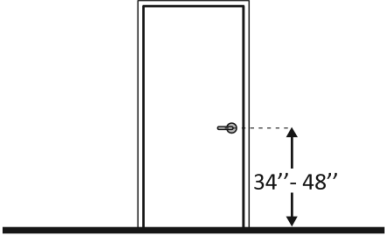
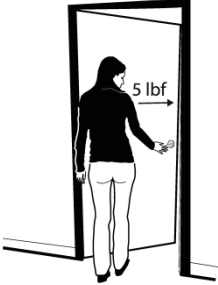
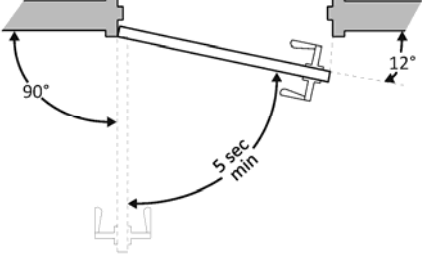
<p>2.43 Is the door equipped with hardware that is operable with one hand and does not require tight grasping, pinching and twisting of the wrist?</p>	<p><input checked="" type="checkbox"/> Yes <input type="checkbox"/> No</p>			
<p>2.44 Are the operable parts of the hardware no less than 34 inches and no greater than 48 inches above the floor?</p>	<p><input checked="" type="checkbox"/> Yes <input type="checkbox"/> No Measurement:</p>			
<p>2.45 Can the door be opened easily (5 pounds maximum force)?</p> <p>Note: You can use a pressure gauge or fish scale to measure force. If you do not have a pressure gauge or fish scale you will need to judge whether the door is easy to open.</p>	<p><input checked="" type="checkbox"/> Yes <input type="checkbox"/> No Measurement:</p>			
<p>2.46 If the door has a closer, does it take at least 5 seconds to close from an open position of 90 degrees to a position of 12 degrees from the latch?</p>	<p><input checked="" type="checkbox"/> Yes <input type="checkbox"/> No Measurement:</p>			

Controls – light switches, security and intercom systems, emergency/alarm boxes, etc. (2010 Standards – 309)

2.50 Is there a clear floor space at least 30 inches wide by at least 48 inches long for a forward or parallel approach?

Yes No

Measurement:

Are the operable parts no higher than 48 inches above the floor?*

Yes No

Measurement:

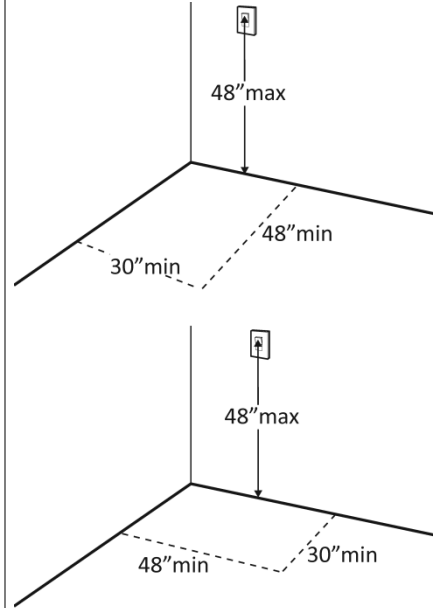

• Relocate control

2.51 Can the control be operated with one hand and without tight grasping, pinching, or twisting of the wrist?

Yes No

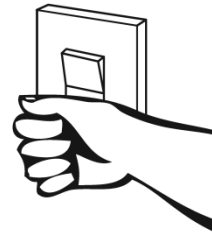

Seating: General – reception areas, waiting rooms, etc. (2010 Standards – 801)

2.68 Is there at least one space at least 36 inches wide by at least 48 inches long for a person in a wheelchair?

Yes No

Measurement:

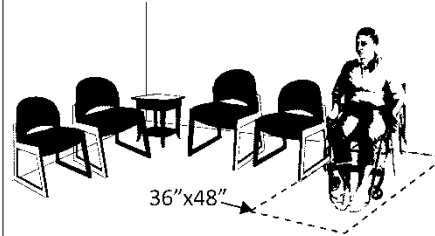

Sales & Service Counters – banks, stores, dry cleaners, auto repair shops, fitness clubs, etc. (2010 Standards – 904)

2.76 Is there a portion of at least one of each type of counter that is:

No higher than 36 inches above the floor?

At least 36 inches long?

Yes No

Measurement:
43"

Yes No

Measurement:

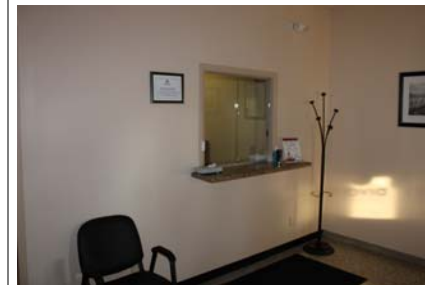
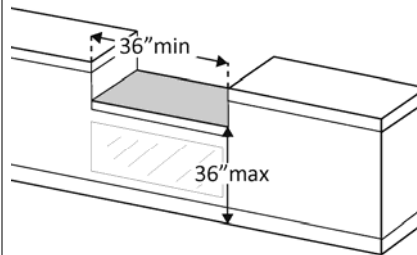
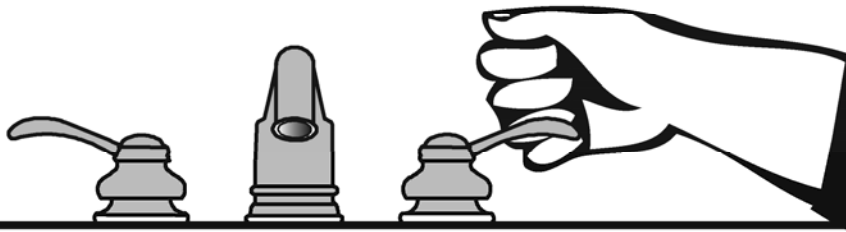

Photo #003

• Lower section of counter

The ADA Checklist for Readily Achievable Barrier Removal

Priority 3 - Toilet Rooms



Project _____

Building _____

Location _____

Date _____

Surveyors _____

Contact Information _____

When toilet rooms are open to the public they should be accessible to people with disabilities.



Institute for Human Centered Design
www.HumanCenteredDesign.org
November 2011





ADA National Network
Questions on the ADA 800-949-4232 voice/tty
www.ADAchecklist.org



This checklist was produced by the New England ADA Center, a project of the Institute for Human Centered Design and a member of the ADA National Network. This checklist was developed under a grant from the Department of Education, NIDRR grant number H133A060092-09A. However the contents do not necessarily represent the policy of the Department of Education, and you should not assume endorsement by the Federal Government.

Questions or comments on the checklist contact the New England ADA Center at 617-695-0085 voice/tty or ADAinfo@NewEnglandADA.org

For the full set of checklists, including the checklists for recreation facilities visit www.ADAchecklist.org.

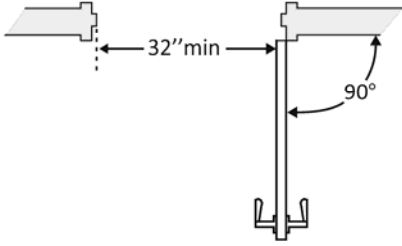
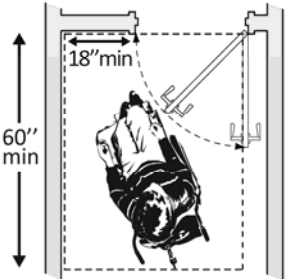
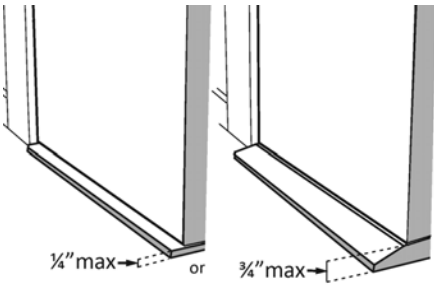
Priority 3 – Toilet Rooms			Comments	Possible Solutions
3.1	If toilet rooms are available to the public, is at least one toilet room accessible? (Either one for each sex, or one unisex.)	<input checked="" type="checkbox"/> Yes <input type="checkbox"/> No		
3.2	Are there signs at inaccessible toilet rooms that give directions to accessible toilet rooms?	<input type="checkbox"/> Yes <input checked="" type="checkbox"/> No		<ul style="list-style-type: none"> • Install signs
3.3	If not all toilet rooms are accessible, is there a sign at the accessible toilet room with the International Symbol of Accessibility?	<input type="checkbox"/> Yes <input checked="" type="checkbox"/> No		<ul style="list-style-type: none"> • Install sign
Accessible Route (2010 Standards – Chapter 4)				
3.4	Is there a route to the accessible toilet room(s) that does not include the use of stairs?	<input checked="" type="checkbox"/> Yes <input type="checkbox"/> No		
	Is the route accessible? (See Priority 2 Interior Accessible Route for specifics.)	<input checked="" type="checkbox"/> Yes <input type="checkbox"/> No		

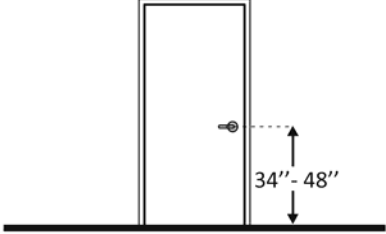

Entrance (2010 Standards – 404)				
<p>3.6 Is the door opening width at least 32 inches clear, between the face of the door and the stop, when the door is open 90 degrees?</p>	<p><input checked="" type="checkbox"/> Yes <input type="checkbox"/> No</p> <p>Measurement:</p>			
<p>3.7 If there is a front approach to the pull side of the door is there at least 18 inches of maneuvering clearance beyond the latch side plus 60 inches clear depth?</p> <p>On both sides of the door, is the floor surface of the maneuvering clearance level (no steeper than 1:48)?</p>	<p><input checked="" type="checkbox"/> Yes <input type="checkbox"/> No</p> <p>Measurement:</p> <p><input checked="" type="checkbox"/> Yes <input type="checkbox"/> No</p> <p>Measurement:</p>			
<p>3.8 Is the door threshold edge no more than ¼ inch high?</p> <p>Or</p> <p>No more than ¾ inch high if slope is beveled no steeper than 1:2?</p> <p>Note: The first ¼ inch of the threshold may be vertical; the rest must be beveled.</p>	<p><input checked="" type="checkbox"/> Yes <input type="checkbox"/> No</p> <p>Measurement:</p> <p><input checked="" type="checkbox"/> Yes <input type="checkbox"/> No</p> <p>Measurement:</p>			

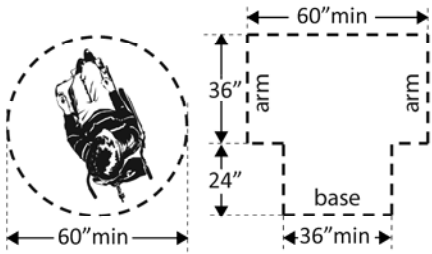
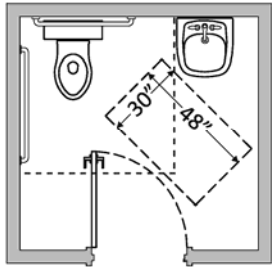

<p>3.9 Is the door equipped with hardware that is operable with one hand and does not require tight grasping, pinching, or twisting of the wrist? Check door handle and lock (if provided).</p>	<p><input checked="" type="checkbox"/> Yes <input type="checkbox"/> No Measurement:</p>			
<p>3.10 Are the operable parts of the door hardware mounted no less than 34 inches and no greater than 48 inches above the floor?</p>	<p><input checked="" type="checkbox"/> Yes <input type="checkbox"/> No Measurement:</p>			
<p>3.11 Can the door be opened easily (5 pounds maximum force)?</p>	<p><input checked="" type="checkbox"/> Yes <input type="checkbox"/> No Measurement:</p>			
<p>In the Toilet Room</p>				
<p>3.16 Is there a clear path to at least one of each type of fixture, e.g. lavatory, hand dryer, etc., that is at least 36 inches wide?</p>	<p><input checked="" type="checkbox"/> Yes <input type="checkbox"/> No Measurement:</p>			

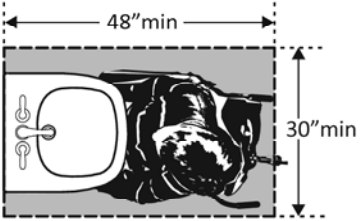
<p>3.17 Is there clear floor space available for a person in a wheelchair to turn around, i.e. a circle at least 60 inches in diameter or a T-shaped space within a 60-inch square?*</p>	<p><input checked="" type="checkbox"/> Yes <input type="checkbox"/> No</p> <p>Measurement:</p>			
<p>3.18 In a single user toilet room if the door swings in and over a clear floor space at an accessible fixture, is there a clear floor space at least 30 x 48 inches beyond the swing of the door?</p>	<p><input checked="" type="checkbox"/> Yes <input type="checkbox"/> No</p> <p>Measurement:</p>			

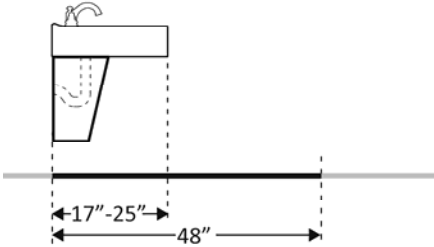
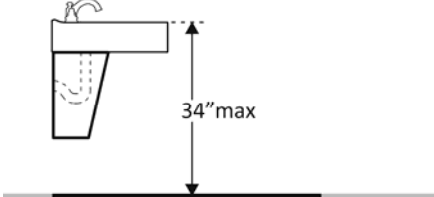
Lavatories (2010 Standards – 606) Note: 2010 Standards refer to sinks in toilet rooms as lavatories.

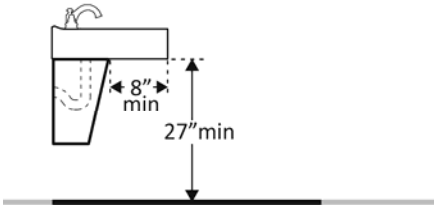
<p>3.21 Does at least one lavatory have a clear floor space for a forward approach at least 30 inches wide and 48 inches long?</p>	<p><input checked="" type="checkbox"/> Yes <input type="checkbox"/> No</p> <p>Measurement:</p>			
-------------------------------------------------------------------------------------------------------------------------------------------	------------------------------------------------------------------------------------------------	--------------------------------------------------------------------------------------	--	--

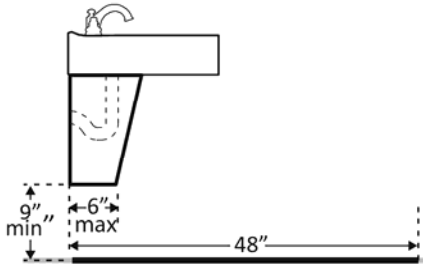
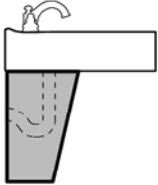
<p>3.22 Do no less than 17 inches and no greater than 25 inches of the clear floor space extend under the lavatory so that a person using a wheelchair can get close enough to reach the faucet?</p>	<p><input checked="" type="checkbox"/> Yes <input type="checkbox"/> No Measurement:</p>			
<p>3.23 Is the front of the lavatory or counter surface, whichever is higher, no more than 34 inches above the floor?</p>	<p><input type="checkbox"/> Yes <input checked="" type="checkbox"/> No Measurement: 34-1/2"</p>		 <p>Photo #004</p>	<ul style="list-style-type: none"> • Alter lavatory
<p>3.24 Is there at least 27 inches clearance from the floor to the bottom of the lavatory that extends at least 8 inches under the lav for knee clearance?</p>	<p><input checked="" type="checkbox"/> Yes <input type="checkbox"/> No Measurement:</p>			

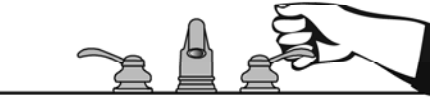
<p>3.25 Is there toe clearance at least 9 inches high? (Space extending greater than 6 inches beyond the available toe clearance at 9 inches above the floor is not considered toe clearance.)</p>	<p><input checked="" type="checkbox"/> Yes <input type="checkbox"/> No</p>			
<p>3.26 Are pipes below the lavatory insulated or otherwise configured to protect against contact?</p>	<p><input type="checkbox"/> Yes <input checked="" type="checkbox"/> No</p>		 <p>Photo #005</p>	<ul style="list-style-type: none"> • Install insulation
<p>3.27 Can the faucet be operated without tight grasping, pinching, or twisting of the wrist? Is the force required to activate the faucet no greater than 5 pounds?</p>	<p><input checked="" type="checkbox"/> Yes <input type="checkbox"/> No <input checked="" type="checkbox"/> Yes <input type="checkbox"/> No</p>			

Soap Dispensers and Hand Dryers (2010 Standards – 603)

3.28 Are the operable parts of the soap dispenser within one of the following reach ranges:

Above lavatories or counters no less than 20 inches and no greater than 25 inches deep: no higher than 44 inches above the floor?

Above lavatories less than 20 inches deep: no higher than 48 inches above the floor?

Not over an obstruction: no higher than 48 inches above the floor?

Yes No
Measurement:

Yes No
Measurement:

Yes No
Measurement:

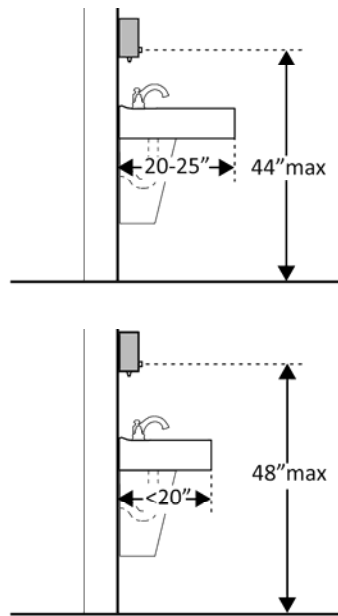

3.29 Are the operable parts of the hand dryer or towel dispenser within one of the following reach ranges:

Above lavatories or counters no less than 20 inches and no greater than 25 inches deep: no higher than 44 inches above the floor?

Above lavatories less than 20 inches deep: no higher than 48 inches above the floor?

Yes No
Measurement:

Yes No
Measurement:

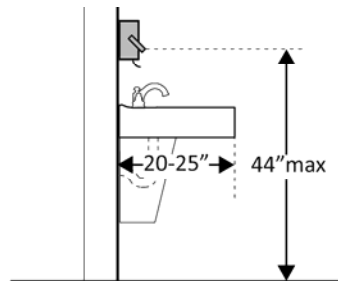

• Adjust dispensers

<p>Not over an obstruction: no higher than 48 inches above the floor?</p> <p>Can the operable parts of the hand dryer or towel dispenser be operated without tight grasping, pinching or twisting of the wrist?</p> <p>Is the force required to activate the hand dryer or towel dispenser no greater than 5 pounds?</p>	<p><input type="checkbox"/> Yes <input checked="" type="checkbox"/> No</p> <p>Measurement:</p> <p><input type="checkbox"/> Yes <input type="checkbox"/> No</p> <p><input type="checkbox"/> Yes <input type="checkbox"/> No</p> <p>Measurement:</p>			
--------------------------------------------------------------------------------------------------------------------------------------------------------------------------------------------------------------------------------------------------------------------------------------------------------------------------	----------------------------------------------------------------------------------------------------------------------------------------------------------------------------------------------------------------------------------------------------	--	--	--

Water Closets in Single-User Toilet Rooms and Compartments (Stalls) (2010 Standards – 603 & 609) Note: 2010 Standards refer to toilets as water closets.

<p>3.30 Is the centerline of the water closet no less than 16 inches and no greater than 18 inches from the side wall or partition?</p>	<p><input type="checkbox"/> Yes <input checked="" type="checkbox"/> No</p> <p>Measurement: 32"</p>		<p>Photo #006</p>	<ul style="list-style-type: none"> • Move toilet
------------------------------------------------------------------------------------------------------------------------------------------------	----------------------------------------------------------------------------------------------------	--	-------------------	-----------------------------------------------------------------

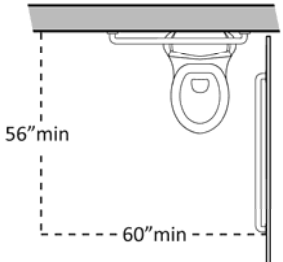
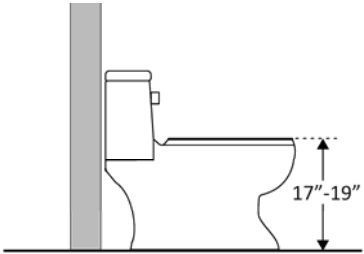
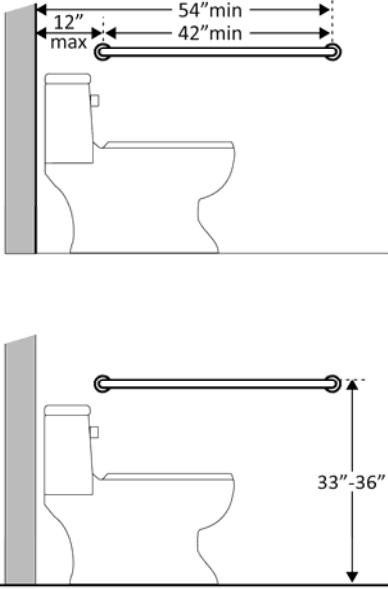
<p>3.31 Is clearance provided around the water closet measuring at least 60 inches from the side wall and at least 56 inches from the rear wall?*</p>	<p><input checked="" type="checkbox"/> Yes <input type="checkbox"/> No</p> <p>Measurement:</p>		
<p>3.32 Is the height of the water closet no less than 17 inches and no greater than 19 inches above the floor measured to the top of the seat?</p>	<p><input checked="" type="checkbox"/> Yes <input type="checkbox"/> No</p> <p>Measurement:</p>		
<p>3.33 Is there a grab bar at least 42 inches long on the side wall?</p> <p>Is it located no more than 12 inches from the rear wall?</p> <p>Does it extend at least 54 inches from the rear wall?</p> <p>Is it mounted no less than 33 inches and no greater than 36 inches above the floor to the top of the gripping surface?</p> <p>Is there at least 12 inches clearance between the grab bar and protruding objects above?*</p>	<p><input type="checkbox"/> Yes <input checked="" type="checkbox"/> No</p> <p>Measurement:</p> <p><input checked="" type="checkbox"/> Yes <input type="checkbox"/> No</p> <p>Measurement:</p> <p><input type="checkbox"/> Yes <input checked="" type="checkbox"/> No</p> <p>Measurement:</p> <p><input checked="" type="checkbox"/> Yes <input type="checkbox"/> No</p> <p>Measurement:</p> <p><input checked="" type="checkbox"/> Yes <input type="checkbox"/> No</p> <p>Measurement:</p>		<ul style="list-style-type: none"> • Replace grab bar

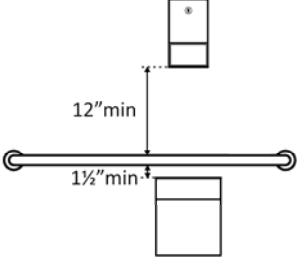
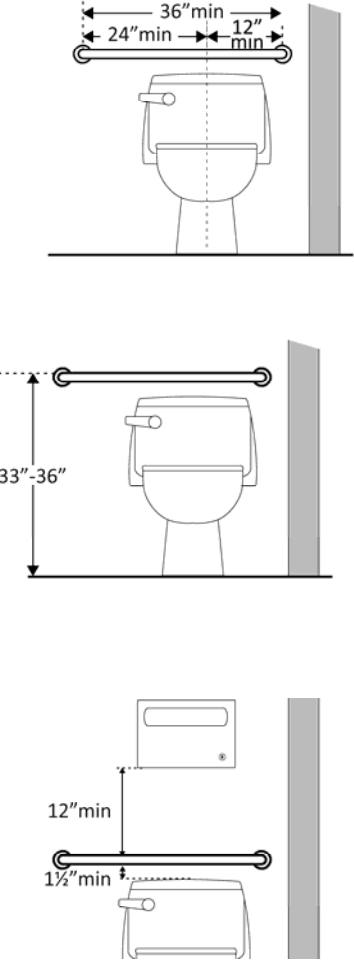
<p>Is there at least 1½ inches clearance between the grab bar and projecting objects below?*</p> <p>Is the space between the wall and the grab bar 1 ½ inches?</p>	<p><input checked="" type="checkbox"/> Yes <input type="checkbox"/> No Measurement:</p> <p><input checked="" type="checkbox"/> Yes <input type="checkbox"/> No Measurement:</p>			
<p>3.34 Is there a grab bar at least 36 inches long on the rear wall?</p> <p>Does it extend at least 12 inches from the centerline of the water closet on one side (side wall)?</p> <p>Does it extend at least 24 inches on the other (open) side?</p> <p>Is it mounted no less than 33 inches and no greater than 36 inches above the floor to the top of the gripping surface?</p> <p>Are there at least 12 inches clearance between the grab bar and protruding objects above?*</p> <p>Are there at least 1½ inches clearance between the grab bar and projecting objects below?*</p>	<p><input checked="" type="checkbox"/> Yes <input type="checkbox"/> No Measurement:</p> <p><input checked="" type="checkbox"/> Yes <input type="checkbox"/> No Measurement:</p> <p><input checked="" type="checkbox"/> Yes <input type="checkbox"/> No Measurement:</p> <p><input checked="" type="checkbox"/> Yes <input type="checkbox"/> No Measurement:</p> <p><input checked="" type="checkbox"/> Yes <input type="checkbox"/> No Measurement:</p> <p><input checked="" type="checkbox"/> Yes <input type="checkbox"/> No Measurement:</p>			

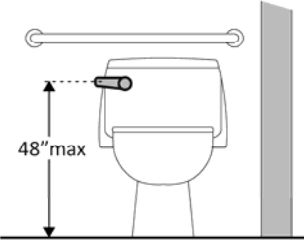
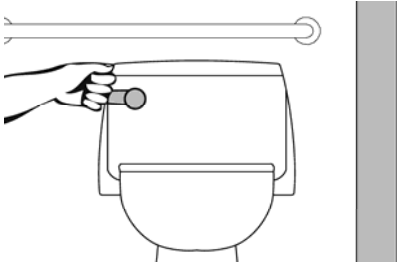
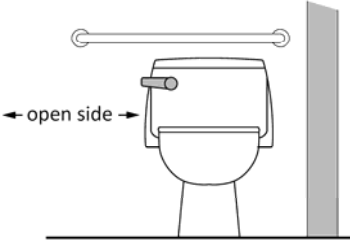
<p>Is the space between the wall and the grab bar 1 ½ inches?</p>	<p><input checked="" type="checkbox"/> Yes <input type="checkbox"/> No Measurement:</p>			
<p>3.35 If the flush control is hand operated, is the operable part located no higher than 48 inches above the floor?</p>	<p><input checked="" type="checkbox"/> Yes <input type="checkbox"/> No Measurement:</p>			
<p>3.36 If the flush control is hand operated, can it be operated with one hand and without tight grasping, pinching, or twisting of the wrist?</p> <p>Is the force required to activate the flush control no greater than 5 pounds?</p>	<p><input checked="" type="checkbox"/> Yes <input type="checkbox"/> No <input checked="" type="checkbox"/> Yes <input type="checkbox"/> No Measurement:</p>			
<p>3.37 Is the flush control on the open side of the water closet?</p>	<p><input checked="" type="checkbox"/> Yes <input type="checkbox"/> No</p>			

<p>3.38 Is the toilet paper dispenser located no less than 7 inches and no greater than 9 inches from the front of the water closet to the centerline of the dispenser?*</p>	<p><input checked="" type="checkbox"/> Yes <input type="checkbox"/> No</p> <p>Measurement:</p>			
<p>3.39 Is the outlet of the dispenser:</p> <p>Located no less than 15 inches and no greater than 48 inches above the floor?</p> <p>Not located behind grab bars?</p>	<p><input checked="" type="checkbox"/> Yes <input type="checkbox"/> No</p> <p>Measurement:</p> <p><input checked="" type="checkbox"/> Yes <input type="checkbox"/> No</p>			
<p>3.40 Does the dispenser allow continuous paper flow?</p>	<p><input checked="" type="checkbox"/> Yes <input type="checkbox"/> No</p>			



Photo #001



Photo #002

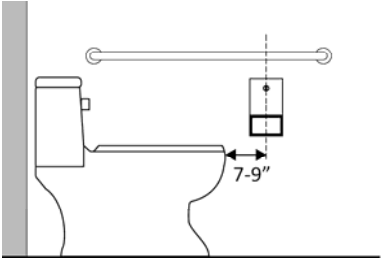
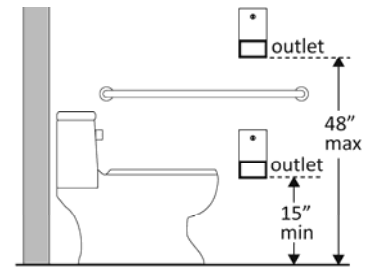
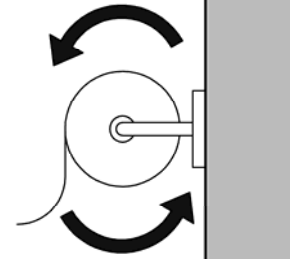
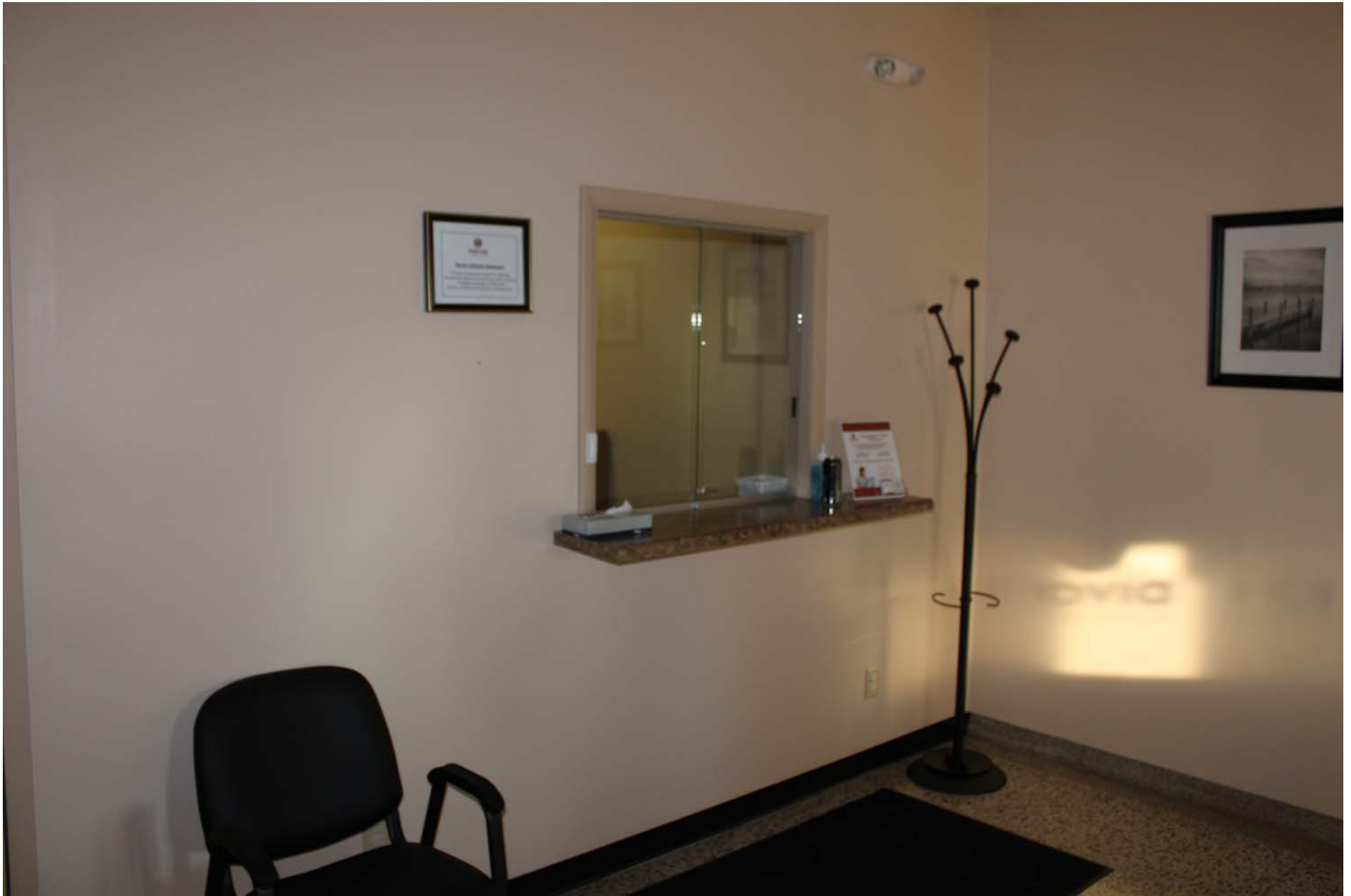

Photo #003



Photo #004



Photo #005



Photo #006

ADA Checklist for Readily Achievable Barrier Removal

Priority 1 – Approach & Entrance



Project Cass Count ADA Transition Plan

Building Cass County Annex - Consolidated Union

Location Logansport, IN

Date 12/10/2012

Surveyors Henry Stellema & Dustin Schrougham

Contact Information 1-800-321-6959

An accessible route from site arrival points and an accessible entrance should be provided for everyone.



Institute for Human Centered Design
www.HumanCenteredDesign.org

November 2011





ADA National Network
Questions on the ADA 800-949-4232 voice/tty



www.ADAchecklist.org

This checklist was produced by the New England ADA Center, a project of the Institute for Human Centered Design and a member of the ADA National Network. This checklist was developed under a grant from the Department of Education, NIDRR grant number H133A060092-09A. However the contents do not necessarily represent the policy of the Department of Education, and you should not assume endorsement by the Federal Government.

Questions or comments on the checklist contact the New England ADA Center at 617-695-0085 voice/tty or ADAinfo@NewEnglandADA.org

For the full set of checklists, including the checklists for recreation facilities visit www.ADAchecklist.org.

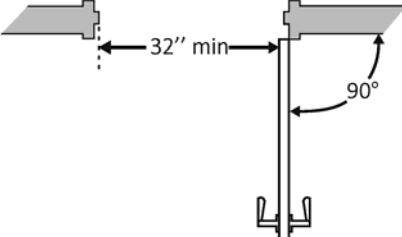
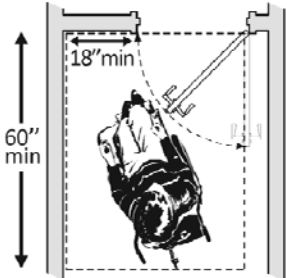
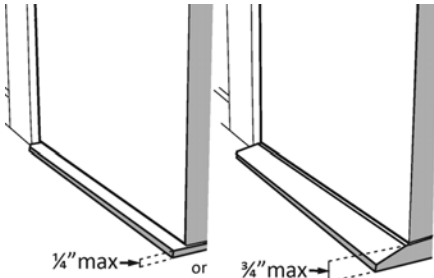
Priority 1 – Approach & Entrance		Comments	Possible Solutions
Entrance (2010 Standards – 404)			
<p>1.37 Is the main entrance accessible?</p>	<input checked="" type="checkbox"/> Yes <input type="checkbox"/> No		
<p>1.38 If the main entrance is not accessible, is there an alternative accessible entrance?</p> <p>Can the alternative accessible entrance be used independently and during the same hours as the main entrance?</p>	<input type="checkbox"/> Yes <input checked="" type="checkbox"/> No <input type="checkbox"/> Yes <input checked="" type="checkbox"/> No		
<p>1.39 Do all inaccessible entrances have signs indicating the location of the nearest accessible entrance?</p>	<input type="checkbox"/> Yes <input checked="" type="checkbox"/> No		

<p>1.40 If not all entrances are accessible, is there a sign at the accessible entrance with the International Symbol of Accessibility?</p>	<p><input type="checkbox"/> Yes <input checked="" type="checkbox"/> No</p>		<ul style="list-style-type: none"> • Install sign
<p>1.41 Is the clear opening width of the accessible entrance door at least 32 inches, between the face of the door and the stop, when the door is open 90 degrees?</p>	<p><input checked="" type="checkbox"/> Yes <input type="checkbox"/> No Measurement:</p>		
<p>1.42 If there is a front approach to the pull side of the door, is there at least 18 inches of maneuvering clearance beyond the latch side plus at least 60 inches clear depth?</p> <p>On both sides of the door, is the ground or floor surface of the maneuvering clearance level (no steeper than 1:48)?</p>	<p><input checked="" type="checkbox"/> Yes <input type="checkbox"/> No Measurement:</p> <p><input checked="" type="checkbox"/> Yes <input type="checkbox"/> No Measurement:</p>		
<p>1.43 Is the door threshold edge no more than ¼ inch high?</p> <p>Or</p> <p>No more than ¾ inch high if slope is beveled no steeper than 1:2?</p>	<p><input type="checkbox"/> Yes <input checked="" type="checkbox"/> No Measurement:</p> <p><input type="checkbox"/> Yes <input checked="" type="checkbox"/> No Measurement:</p>		 <p>Photo #001</p> <ul style="list-style-type: none"> • Replace concrete stoop to remove height difference.

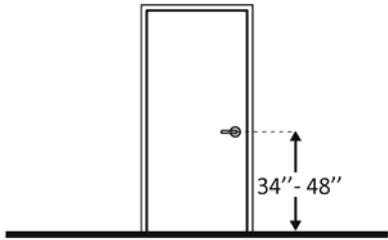
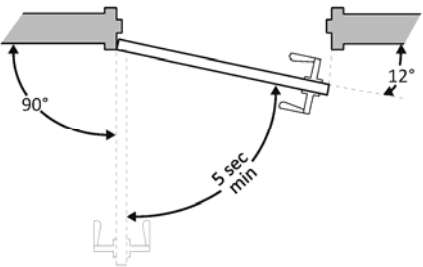
<p>Note: The first ¼ inch of the threshold may be vertical; the rest must be beveled.</p>				
<p>1.44 Is the door equipped with hardware, including locks, that is operable with one hand and does not require tight grasping, pinching, or twisting of the wrist?</p>	<p><input checked="" type="checkbox"/> Yes <input type="checkbox"/> No</p>			
<p>1.45 Are the operable parts of the door hardware no less than 34 inches and no greater than 48 inches above the floor or ground surface?</p>	<p><input checked="" type="checkbox"/> Yes <input type="checkbox"/> No Measurement:</p>			
<p>1.46 If the door has a closer, does it take at least 5 seconds to close from an open position of 90 degrees to a position of 12 degrees from the latch?</p>	<p><input checked="" type="checkbox"/> Yes <input type="checkbox"/> No Measurement:</p>			

<p>1.48 If provided at the building entrance, are carpets or mats no higher than ½ inch thick?</p>	<p><input checked="" type="checkbox"/> Yes <input type="checkbox"/> No</p> <p>Measurement:</p>			
<p>1.49 Are edges of carpets or mats securely attached to minimize tripping hazards?</p>	<p><input type="checkbox"/> Yes <input checked="" type="checkbox"/> No</p>			<ul style="list-style-type: none"> • Secure carpeting or mats at edges

ADA Checklist for Readily Achievable Barrier Removal

Priority 2 – Access to Goods & Services

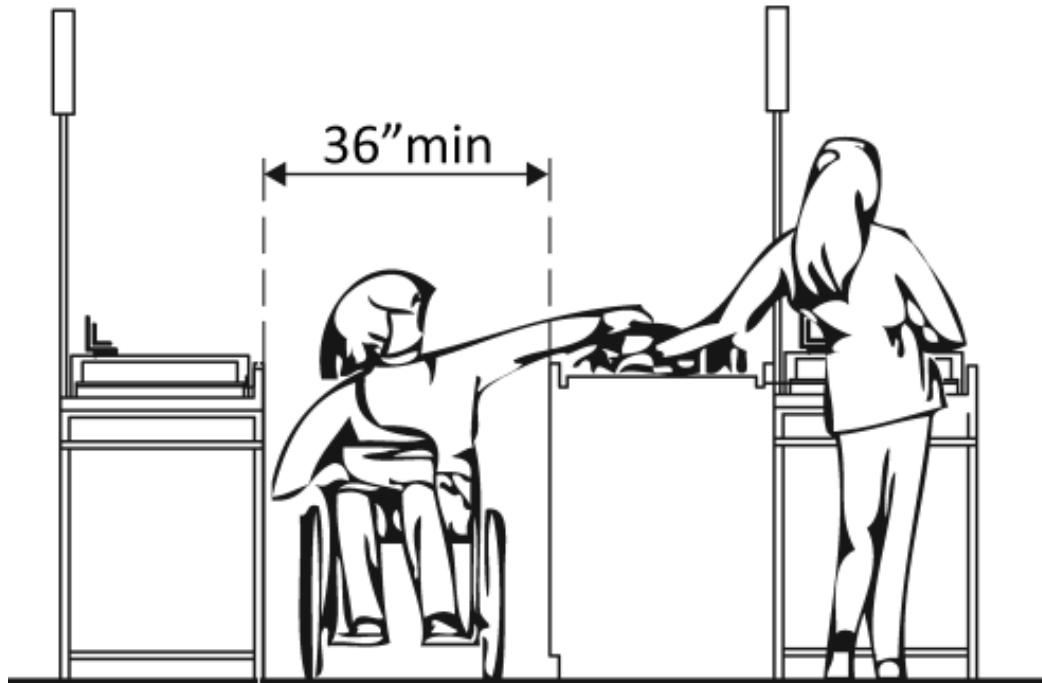

Project _____

Building _____

Location _____

Date _____

Surveyors _____

Contact Information _____

The layout of the building should allow people with disabilities to obtain goods and services and to participate in activities without assistance.



Institute for Human Centered Design
www.HumanCenteredDesign.org
November 2011





ADA National Network
Questions on the ADA 800-949-4232 voice/tty
www.ADAchecklist.org

This checklist was produced by the New England ADA Center, a project of the Institute for Human Centered Design and a member of the ADA National Network. This checklist was developed under a grant from the Department of Education, NIDRR grant number H133A060092-09A. However the contents do not necessarily represent the policy of the Department of Education, and you should not assume endorsement by the Federal Government.

Questions or comments on the checklist contact the New England ADA Center at 617-695-0085 voice/tty or ADAinfo@NewEnglandADA.org

For the full set of checklists, including the checklists for recreation facilities visit www.ADAchecklist.org.

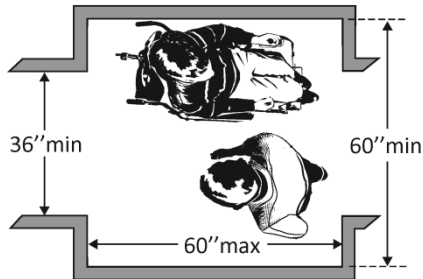
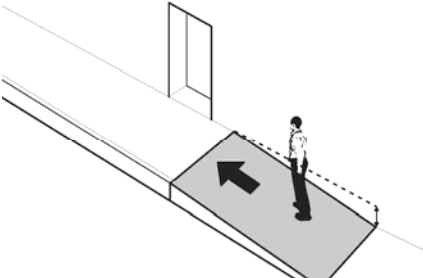
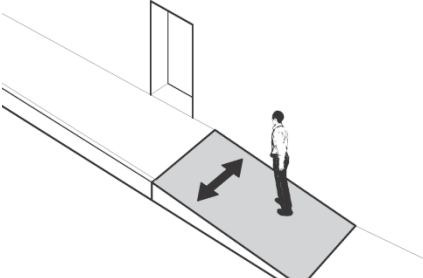
Priority 2 – Access to Goods & Services		Comments	Possible Solutions
2.1	Does the accessible entrance provide direct access to the main floor, lobby and elevator? <input checked="" type="checkbox"/> Yes <input type="checkbox"/> No		
Interior Accessible Route (2010 Standards – Ch.4)			
2.2	Are all public spaces on at least one accessible route? <input checked="" type="checkbox"/> Yes <input type="checkbox"/> No		
2.3	Is the route stable, firm and slip-resistant? <input checked="" type="checkbox"/> Yes <input type="checkbox"/> No		
2.4	Is the route at least 36 inches wide? Note: The accessible route can narrow to 32 inches min. for a max. of 24 inches. These narrower portions of the route must be at least 48 inches from each other. Measurement:	<p>The diagram illustrates two scenarios for wheelchair access. The top scenario shows a wheelchair on a path that is at least 36 inches wide. The bottom scenario shows a wheelchair on a path that is at least 32 inches wide, with narrow sections of 24 inches maximum width. These narrow sections must be separated by a distance of 48 inches maximum.</p>	

<p>2.5 If the route is greater than 200 feet in length and no less than 36 inches wide, is there a passing space no less than 60 x 60 inches?</p>	<p><input checked="" type="checkbox"/> Yes <input type="checkbox"/> No</p> <p>Measurement:</p>			
<p>2.6 Is the running slope no steeper than 1:20, i.e. for every inch of height change there are at least 20 inches of route run?</p>	<p><input checked="" type="checkbox"/> Yes <input type="checkbox"/> No</p> <p>Measurement:</p>			
<p>2.7 Is the cross slope no steeper than 1:48?</p>	<p><input checked="" type="checkbox"/> Yes <input type="checkbox"/> No</p> <p>Measurement:</p>			
<p>2.8 Do all objects on circulation paths through public areas, e.g. fire extinguishers, drinking fountains, signs, etc., protrude no more than 4 inches into the path? Or If an object protrudes more than 4 inches, is the bottom leading edge at 27 inches or lower above the floor?</p>	<p><input checked="" type="checkbox"/> Yes <input type="checkbox"/> No</p> <p>Measurement:</p> <p><input checked="" type="checkbox"/> Yes <input type="checkbox"/> No</p> <p>Measurement:</p>	 <p style="text-align: center;">Or</p>		

Or
Is the bottom leading edge at 80 inches or higher above the floor?

Yes No

Measurement:

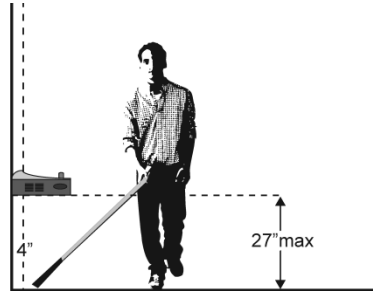

Or

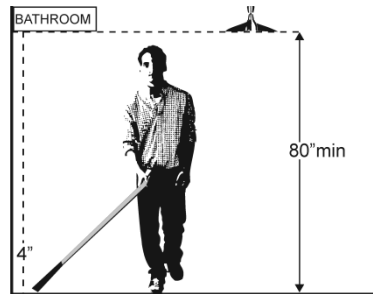

Interior Doors – to classrooms, medical exam rooms, conference rooms, etc. (2010 Standards – 404)

2.40 Is the door opening width at least 32 inches clear, between the face of the door and the stop, when the door is open 90 degrees?

Yes No

Measurement:

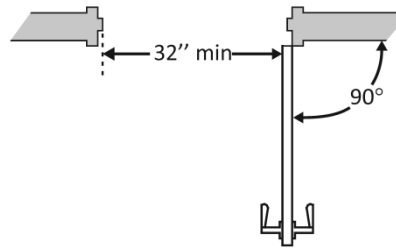

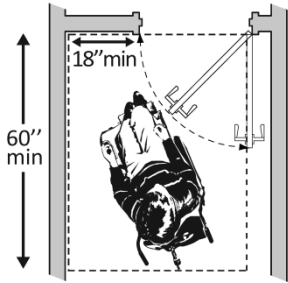
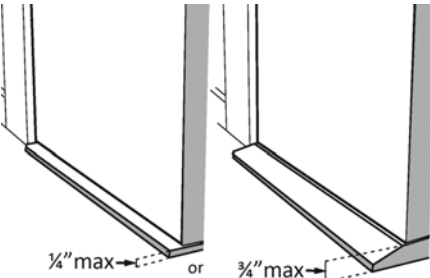
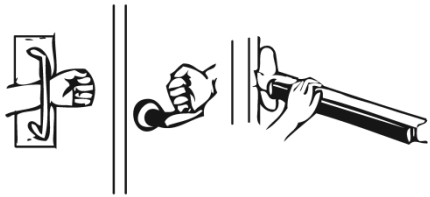
<p>2.41 If there is a front approach to the pull side of the door, is there at least 18 inches of maneuvering clearance beyond the latch side plus at least 60 inches clear depth?</p> <p>On both sides of the door, is the floor surface of the maneuvering clearance level (no steeper than 1:48)?</p>	<p><input checked="" type="checkbox"/> Yes <input type="checkbox"/> No</p> <p>Measurement:</p> <p><input checked="" type="checkbox"/> Yes <input type="checkbox"/> No</p> <p>Measurement:</p>			
<p>2.42 Is the door threshold edge no more than ¼ inch high?</p> <p>Or</p> <p>No more than ¾ inch high if slope is beveled no steeper than 1:2?</p> <p>Note: The first ¼ inch of the threshold may be vertical; the rest must be beveled.</p>	<p><input checked="" type="checkbox"/> Yes <input type="checkbox"/> No</p> <p>Measurement:</p> <p><input checked="" type="checkbox"/> Yes <input type="checkbox"/> No</p> <p>Measurement:</p>			
<p>2.43 Is the door equipped with hardware that is operable with one hand and does not require tight grasping, pinching and twisting of the wrist?</p>	<p><input checked="" type="checkbox"/> Yes <input type="checkbox"/> No</p>			

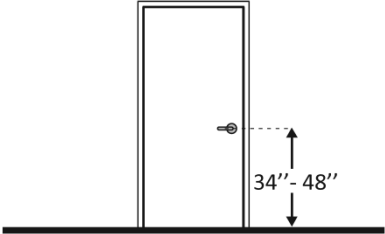
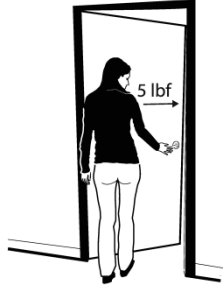
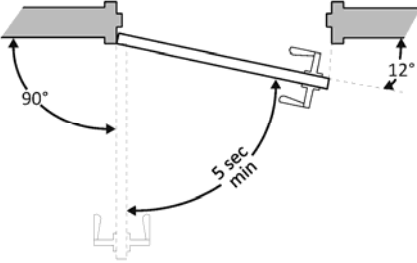
<p>2.44 Are the operable parts of the hardware no less than 34 inches and no greater than 48 inches above the floor?</p>	<p><input checked="" type="checkbox"/> Yes <input type="checkbox"/> No</p> <p>Measurement:</p>			
<p>2.45 Can the door be opened easily (5 pounds maximum force)?</p> <p>Note: You can use a pressure gauge or fish scale to measure force. If you do not have a pressure gauge or fish scale you will need to judge whether the door is easy to open.</p>	<p><input checked="" type="checkbox"/> Yes <input type="checkbox"/> No</p> <p>Measurement:</p>			
<p>2.46 If the door has a closer, does it take at least 5 seconds to close from an open position of 90 degrees to a position of 12 degrees from the latch?</p>	<p><input checked="" type="checkbox"/> Yes <input type="checkbox"/> No</p> <p>Measurement:</p>			

Controls – light switches, security and intercom systems, emergency/alarm boxes, etc. (2010 Standards – 309)

<p>2.50 Is there a clear floor space at least 30 inches wide by at least 48 inches long for a forward or parallel approach?</p> <p>Are the operable parts no higher than 48 inches above the floor?*</p>	<p><input checked="" type="checkbox"/> Yes <input type="checkbox"/> No</p> <p>Measurement:</p> <p><input checked="" type="checkbox"/> Yes <input type="checkbox"/> No</p> <p>Measurement:</p>			
-----------------------------------------------------------------------------------------------------------------------------------------------------------------------------------------------------------------	-----------------------------------------------------------------------------------------------------------------------------------------------------------------------------------------------	--	--	--

<p>2.51 Can the control be operated with one hand and without tight grasping, pinching, or twisting of the wrist?</p>	<p><input checked="" type="checkbox"/> Yes <input type="checkbox"/> No</p>			
------------------------------------------------------------------------------------------------------------------------------	----------------------------------------------------------------------------	--	--	--

Seating: General – reception areas, waiting rooms, etc. (2010 Standards – 801)

<p>2.68 Is there at least one space at least 36 inches wide by at least 48 inches long for a person in a wheelchair?</p>	<p><input checked="" type="checkbox"/> Yes <input type="checkbox"/> No</p> <p>Measurement:</p>			
---------------------------------------------------------------------------------------------------------------------------------	------------------------------------------------------------------------------------------------	--	--	--

Kitchens and Kitchenettes (2010 Standards –804)				
2.89	If a pass through kitchen is provided, is 40" clear provided between cabinets?	<input checked="" type="checkbox"/> Yes <input type="checkbox"/> No	Measurement:	
2.91	Is work surface no greater than 34" AFF?	<input type="checkbox"/> Yes <input checked="" type="checkbox"/> No		<ul style="list-style-type: none"> • Lower counter height.
2.92	Does sink comply with the requirement of items 3.21-3.27?	<input type="checkbox"/> Yes <input checked="" type="checkbox"/> No	Measurement:	 <p>Photo #002</p> <ul style="list-style-type: none"> • Provide knee space beneath counter top
2.93	Does at least 50% of shelf space comply with item 2.xxx?	<input checked="" type="checkbox"/> Yes <input type="checkbox"/> No	Measurement:	

The ADA Checklist for Readily Achievable Barrier Removal

Priority 3 - Toilet Rooms

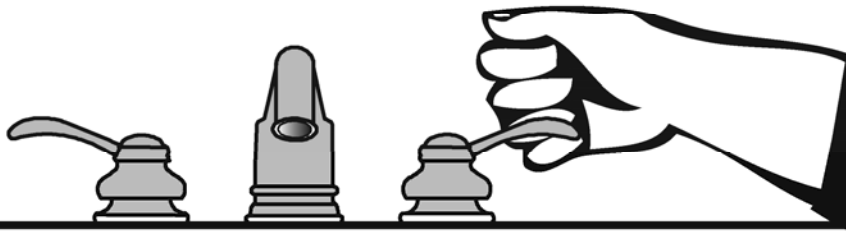

Project _____

Building _____

Location _____

Date _____

Surveyors _____

Contact Information _____

When toilet rooms are open to the public they should be accessible to people with disabilities.



Institute for Human Centered Design
www.HumanCenteredDesign.org
November 2011





ADA National Network
Questions on the ADA 800-949-4232 voice/tty
www.ADAchecklist.org



This checklist was produced by the New England ADA Center, a project of the Institute for Human Centered Design and a member of the ADA National Network. This checklist was developed under a grant from the Department of Education, NIDRR grant number H133A060092-09A. However the contents do not necessarily represent the policy of the Department of Education, and you should not assume endorsement by the Federal Government.



Questions or comments on the checklist contact the New England ADA Center at 617-695-0085 voice/tty or ADAinfo@NewEnglandADA.org

For the full set of checklists, including the checklists for recreation facilities visit www.ADAchecklist.org.

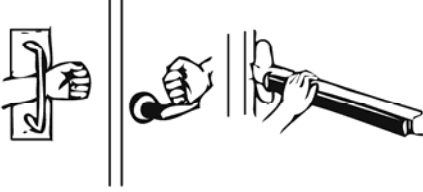
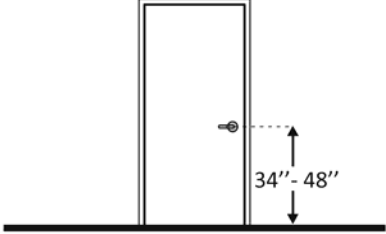
Priority 3 – Toilet Rooms			Comments	Possible Solutions
3.1	If toilet rooms are available to the public, is at least one toilet room accessible? (Either one for each sex, or one unisex.)	<input checked="" type="checkbox"/> Yes <input type="checkbox"/> No		
3.2	Are there signs at inaccessible toilet rooms that give directions to accessible toilet rooms?	<input type="checkbox"/> Yes <input checked="" type="checkbox"/> No		<ul style="list-style-type: none"> • Install signs
3.3	If not all toilet rooms are accessible, is there a sign at the accessible toilet room with the International Symbol of Accessibility?	<input type="checkbox"/> Yes <input checked="" type="checkbox"/> No		<ul style="list-style-type: none"> • Install sign
Accessible Route (2010 Standards – Chapter 4)				
3.4	Is there a route to the accessible toilet room(s) that does not include the use of stairs?	<input checked="" type="checkbox"/> Yes <input type="checkbox"/> No		
	Is the route accessible? (See Priority 2 Interior Accessible Route for specifics.)	<input checked="" type="checkbox"/> Yes <input type="checkbox"/> No		

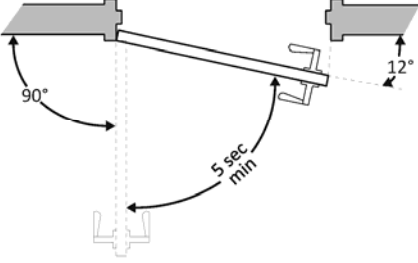
Entrance (2010 Standards – 404)				
<p>3.6 Is the door opening width at least 32 inches clear, between the face of the door and the stop, when the door is open 90 degrees?</p>	<p><input checked="" type="checkbox"/> Yes <input type="checkbox"/> No</p> <p>Measurement:</p>	<p>A side-view diagram of a door frame. The door is swung open to a 90-degree angle. A horizontal double-headed arrow indicates a minimum clear width of 32 inches between the door's face and the stop.</p>		
<p>3.7 If there is a front approach to the pull side of the door is there at least 18 inches of maneuvering clearance beyond the latch side plus 60 inches clear depth?</p> <p>On both sides of the door, is the floor surface of the maneuvering clearance level (no steeper than 1:48)?</p>	<p><input checked="" type="checkbox"/> Yes <input type="checkbox"/> No</p> <p>Measurement:</p> <p><input checked="" type="checkbox"/> Yes <input type="checkbox"/> No</p> <p>Measurement:</p>	<p>A top-down diagram of a door opening. A wheelchair is shown maneuvering through the door. A dashed rectangle indicates a minimum width of 18 inches and a minimum depth of 60 inches. The wheelchair is positioned with its front wheels near the door's latch side.</p>		
<p>3.8 Is the door threshold edge no more than ¼ inch high?</p> <p>Or</p> <p>No more than ¾ inch high if slope is beveled no steeper than 1:2?</p> <p>Note: The first ¼ inch of the threshold may be vertical; the rest must be beveled.</p>	<p><input checked="" type="checkbox"/> Yes <input type="checkbox"/> No</p> <p>Measurement:</p> <p><input checked="" type="checkbox"/> Yes <input type="checkbox"/> No</p> <p>Measurement:</p>	<p>Two side-view diagrams of door thresholds. The left diagram shows a threshold with a maximum height of 1/4 inch. The right diagram shows a beveled threshold with a maximum height of 3/4 inch. The word 'or' is placed between the two diagrams.</p>		

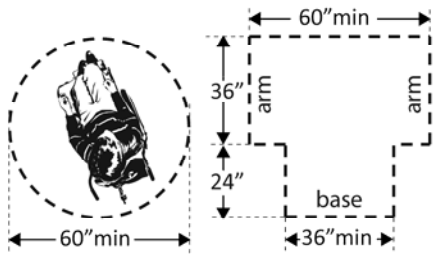
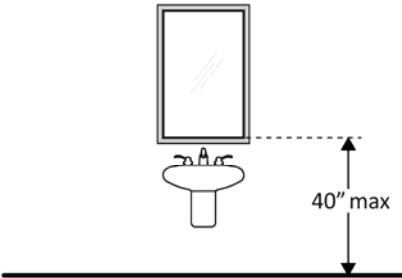
<p>3.9 Is the door equipped with hardware that is operable with one hand and does not require tight grasping, pinching, or twisting of the wrist? Check door handle and lock (if provided).</p>	<p><input checked="" type="checkbox"/> Yes <input type="checkbox"/> No Measurement:</p>			
<p>3.10 Are the operable parts of the door hardware mounted no less than 34 inches and no greater than 48 inches above the floor?</p>	<p><input checked="" type="checkbox"/> Yes <input type="checkbox"/> No Measurement:</p>			
<p>3.11 Can the door be opened easily (5 pounds maximum force)?</p>	<p><input checked="" type="checkbox"/> Yes <input type="checkbox"/> No Measurement:</p>			
<p>3.12 If the door has a closer, does it take at least 5 seconds to close from an open position of 90 degrees to a position of 12 degrees from the latch?</p>	<p><input type="checkbox"/> Yes <input checked="" type="checkbox"/> No Measurement:</p>			<ul style="list-style-type: none"> • Adjust closer

In the Toilet Room				
<p>3.16 Is there a clear path to at least one of each type of fixture, e.g. lavatory, hand dryer, etc., that is at least 36 inches wide?</p>	<p><input checked="" type="checkbox"/> Yes <input type="checkbox"/> No</p> <p>Measurement:</p>			
<p>3.17 Is there clear floor space available for a person in a wheelchair to turn around, i.e. a circle at least 60 inches in diameter or a T-shaped space within a 60-inch square?*</p>	<p><input checked="" type="checkbox"/> Yes <input type="checkbox"/> No</p> <p>Measurement:</p>			
<p>3.19 If the mirror is over a lavatory or countertop, is the bottom edge of the reflecting surface no higher than 40 inches above the floor? Or If the mirror is not over the lavatory or countertop, is the bottom edge of the reflecting surface no higher than 35 inches above the floor?*</p>	<p><input type="checkbox"/> Yes <input checked="" type="checkbox"/> No</p> <p>Measurement: 46"</p> <p><input type="checkbox"/> Yes <input type="checkbox"/> No</p> <p>Measurement:</p>		 <p>Photo #003</p>	<ul style="list-style-type: none"> • Lower the mirror

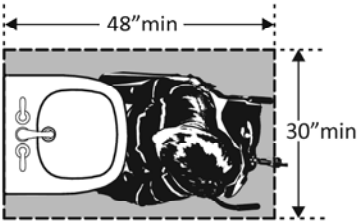
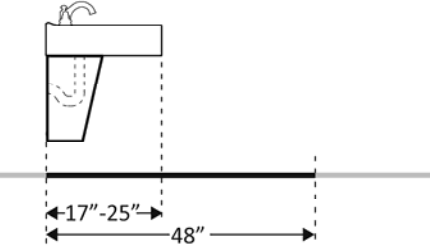
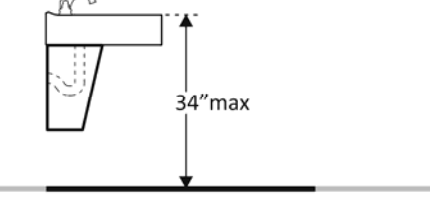
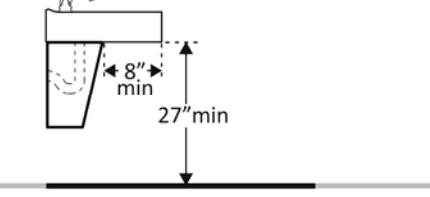
Lavatories (2010 Standards – 606) Note: 2010 Standards refer to sinks in toilet rooms as lavatories.				
<p>3.21 Does at least one lavatory have a clear floor space for a forward approach at least 30 inches wide and 48 inches long?</p>	<p><input checked="" type="checkbox"/> Yes <input type="checkbox"/> No</p> <p>Measurement:</p>			
<p>3.22 Do no less than 17 inches and no greater than 25 inches of the clear floor space extend under the lavatory so that a person using a wheelchair can get close enough to reach the faucet?</p>	<p><input checked="" type="checkbox"/> Yes <input type="checkbox"/> No</p> <p>Measurement:</p>			
<p>3.23 Is the front of the lavatory or counter surface, whichever is higher, no more than 34 inches above the floor?</p>	<p><input checked="" type="checkbox"/> Yes <input type="checkbox"/> No</p> <p>Measurement:</p>			
<p>3.24 Is there at least 27 inches clearance from the floor to the bottom of the lavatory that extends at least 8 inches under the lav for knee clearance?</p>	<p><input checked="" type="checkbox"/> Yes <input type="checkbox"/> No</p> <p>Measurement:</p>			

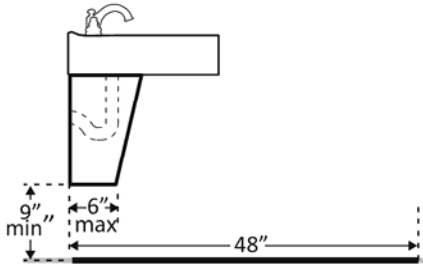
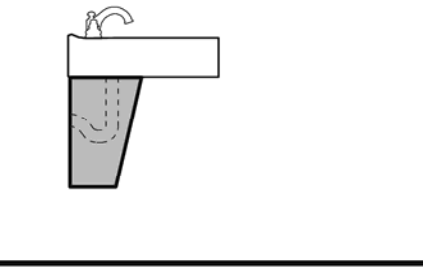
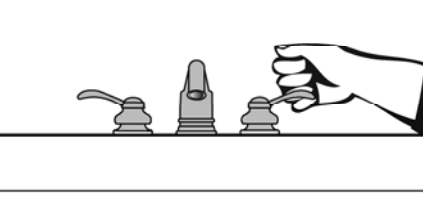
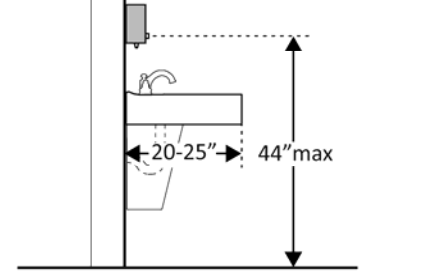
<p>3.25 Is there toe clearance at least 9 inches high? (Space extending greater than 6 inches beyond the available toe clearance at 9 inches above the floor is not considered toe clearance.)</p>	<p><input checked="" type="checkbox"/> Yes <input type="checkbox"/> No</p>			
<p>3.26 Are pipes below the lavatory insulated or otherwise configured to protect against contact?</p>	<p><input checked="" type="checkbox"/> Yes <input type="checkbox"/> No</p>			
<p>3.27 Can the faucet be operated without tight grasping, pinching, or twisting of the wrist? Is the force required to activate the faucet no greater than 5 pounds?</p>	<p><input checked="" type="checkbox"/> Yes <input type="checkbox"/> No <input checked="" type="checkbox"/> Yes <input type="checkbox"/> No</p>			
<p>Soap Dispensers and Hand Dryers (2010 Standards – 603)</p>				
<p>3.28 Are the operable parts of the soap dispenser within one of the following reach ranges: Above lavatories or counters no less than 20 inches and no greater than 25 inches deep; no higher than 44 inches above the floor?</p>	<p><input checked="" type="checkbox"/> Yes <input type="checkbox"/> No Measurement:</p>			

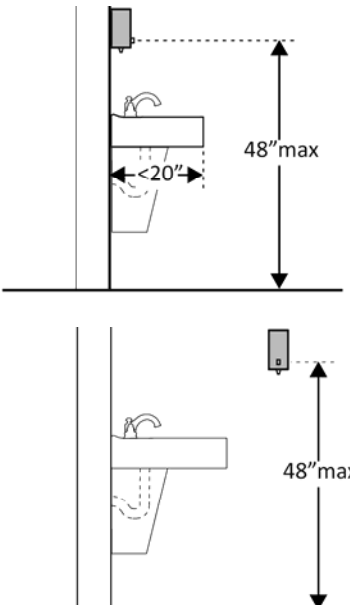
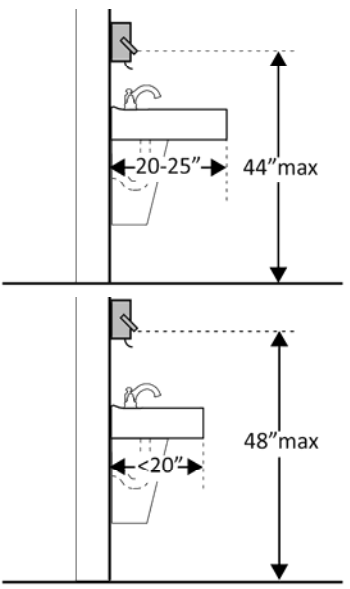
<p>Above lavatories less than 20 inches deep: no higher than 48 inches above the floor?</p> <p>Not over an obstruction: no higher than 48 inches above the floor?</p>	<p><input type="checkbox"/> Yes <input type="checkbox"/> No Measurement:</p> <p><input type="checkbox"/> Yes <input type="checkbox"/> No Measurement:</p>			
<p>3.29 Are the operable parts of the hand dryer or towel dispenser within one of the following reach ranges:</p> <p>Above lavatories or counters no less than 20 inches and no greater than 25 inches deep: no higher than 44 inches above the floor?</p> <p>Above lavatories less than 20 inches deep: no higher than 48 inches above the floor?</p> <p>Not over an obstruction: no higher than 48 inches above the floor?</p>	<p><input type="checkbox"/> Yes <input type="checkbox"/> No Measurement:</p> <p><input type="checkbox"/> Yes <input type="checkbox"/> No Measurement:</p> <p><input checked="" type="checkbox"/> Yes <input type="checkbox"/> No Measurement:</p>			

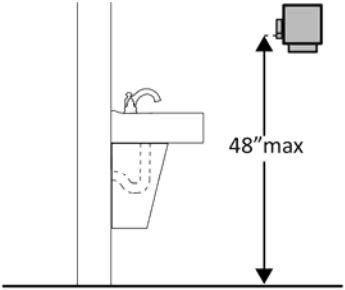
<p>Can the operable parts of the hand dryer or towel dispenser be operated without tight grasping, pinching or twisting of the wrist?</p> <p>Is the force required to activate the hand dryer or towel dispenser no greater than 5 pounds?</p>	<p><input type="checkbox"/> Yes <input type="checkbox"/> No</p> <p><input type="checkbox"/> Yes <input type="checkbox"/> No</p> <p>Measurement:</p>			
------------------------------------------------------------------------------------------------------------------------------------------------------------------------------------------------------------------------------------------------	-----------------------------------------------------------------------------------------------------------------------------------------------------	------------------------------------------------------------------------------------	--	--

Water Closets in Single-User Toilet Rooms and Compartments (Stalls) (2010 Standards – 603 & 609) Note: 2010 Standards refer to toilets as water closets.

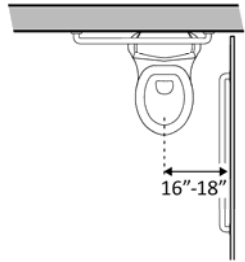
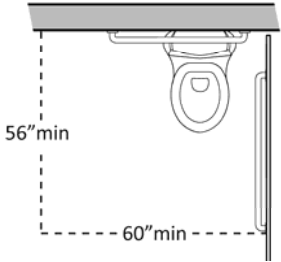
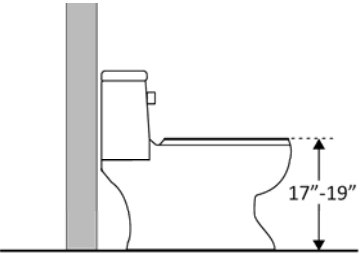

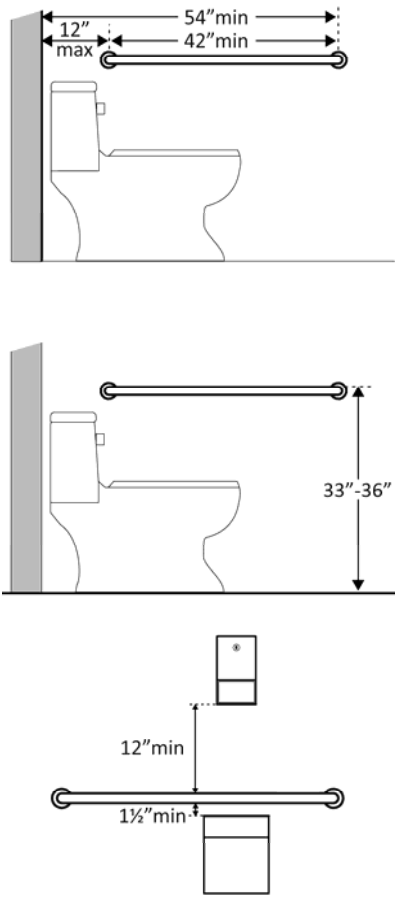
<p>3.30 Is the centerline of the water closet no less than 16 inches and no greater than 18 inches from the side wall or partition?</p>	<p><input checked="" type="checkbox"/> Yes <input type="checkbox"/> No</p> <p>Measurement:</p>			
<p>3.31 Is clearance provided around the water closet measuring at least 60 inches from the side wall and at least 56 inches from the rear wall?*</p>	<p><input type="checkbox"/> Yes <input checked="" type="checkbox"/> No</p> <p>Measurement:</p>			<ul style="list-style-type: none"> • Alter compartment for clearance
<p>3.32 Is the height of the water closet no less than 17 inches and no greater than 19 inches above the floor measured to the top of the seat?</p>	<p><input checked="" type="checkbox"/> Yes <input type="checkbox"/> No</p> <p>Measurement:</p>			

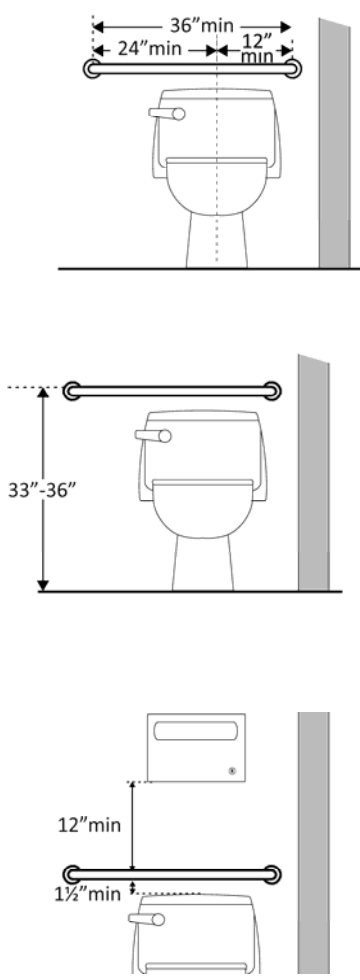
<p>3.33 Is there a grab bar at least 42 inches long on the side wall?</p> <p>Is it located no more than 12 inches from the rear wall?</p> <p>Does it extend at least 54 inches from the rear wall?</p> <p>Is it mounted no less than 33 inches and no greater than 36 inches above the floor to the top of the gripping surface?</p> <p>Is there at least 12 inches clearance between the grab bar and protruding objects above?*</p> <p>Is there at least 1½ inches clearance between the grab bar and projecting objects below?*</p> <p>Is the space between the wall and the grab bar 1 ½ inches?</p>	<p><input checked="" type="checkbox"/> Yes <input type="checkbox"/> No</p> <p>Measurement:</p> <p><input checked="" type="checkbox"/> Yes <input type="checkbox"/> No</p> <p>Measurement:</p> <p><input checked="" type="checkbox"/> Yes <input type="checkbox"/> No</p> <p>Measurement:</p> <p><input checked="" type="checkbox"/> Yes <input type="checkbox"/> No</p> <p>Measurement:</p> <p><input checked="" type="checkbox"/> Yes <input type="checkbox"/> No</p> <p>Measurement:</p> <p><input checked="" type="checkbox"/> Yes <input type="checkbox"/> No</p> <p>Measurement:</p>	 <p>The diagrams illustrate the following requirements for a side wall grab bar:</p> <ul style="list-style-type: none"> Length: The grab bar must be at least 42 inches long and extend at least 54 inches from the rear wall. Distance from Rear Wall: The grab bar must be located no more than 12 inches from the rear wall. Height: The grab bar must be mounted no less than 33 inches and no greater than 36 inches above the floor to the top of the gripping surface. Clearance: There must be at least 12 inches of clearance between the grab bar and protruding objects above, and at least 1½ inches of clearance between the grab bar and projecting objects below. 		
-----------------------------------------------------------------------------------------------------------------------------------------------------------------------------------------------------------------------------------------------------------------------------------------------------------------------------------------------------------------------------------------------------------------------------------------------------------------------------------------------------------------------------------------------------------------------------------------------------------------	-------------------------------------------------------------------------------------------------------------------------------------------------------------------------------------------------------------------------------------------------------------------------------------------------------------------------------------------------------------------------------------------------------------------------------------------------------------------------------------------------------------------------------------------------------------------------------------------	-------------------------------------------------------------------------------------------------------------------------------------------------------------------------------------------------------------------------------------------------------------------------------------------------------------------------------------------------------------------------------------------------------------------------------------------------------------------------------------------------------------------------------------------------------------------------------------------------------------------------------------------------------------------------------------------------------------------------------------------------------------------------------------------------------------------------------------------	--	--

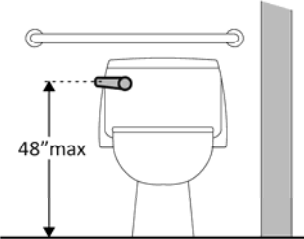
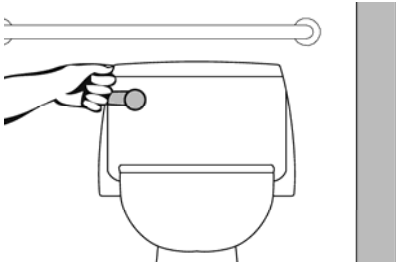
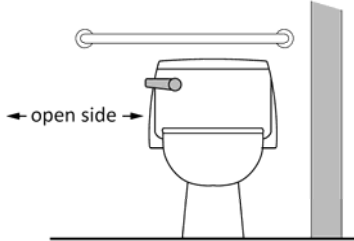
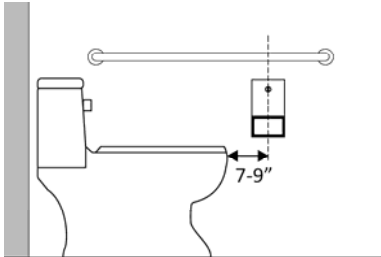
<p>3.34 Is there a grab bar at least 36 inches long on the rear wall?</p> <p>Does it extend at least 12 inches from the centerline of the water closet on one side (side wall)?</p> <p>Does it extend at least 24 inches on the other (open) side?</p> <p>Is it mounted no less than 33 inches and no greater than 36 inches above the floor to the top of the gripping surface?</p> <p>Are there at least 12 inches clearance between the grab bar and protruding objects above?*</p> <p>Are there at least 1½ inches clearance between the grab bar and projecting objects below?*</p> <p>Is the space between the wall and the grab bar 1 ½ inches?</p>	<p><input checked="" type="checkbox"/> Yes <input type="checkbox"/> No</p> <p>Measurement:</p> <p><input checked="" type="checkbox"/> Yes <input type="checkbox"/> No</p> <p>Measurement:</p> <p><input checked="" type="checkbox"/> Yes <input type="checkbox"/> No</p> <p>Measurement:</p> <p><input checked="" type="checkbox"/> Yes <input type="checkbox"/> No</p> <p>Measurement:</p> <p><input checked="" type="checkbox"/> Yes <input type="checkbox"/> No</p> <p>Measurement:</p> <p><input checked="" type="checkbox"/> Yes <input type="checkbox"/> No</p> <p>Measurement:</p>	 <p>The diagrams illustrate the following requirements for a grab bar:</p> <ul style="list-style-type: none"> Length: A horizontal grab bar must be at least 36 inches long. It must extend at least 24 inches to the left of the toilet's centerline and at least 12 inches to the right. Height: The grab bar must be mounted between 33 inches and 36 inches above the floor to the top of the gripping surface. Clearance: There must be at least 12 inches of clearance between the top of the grab bar and any protruding objects above it. There must be at least 1½ inches of clearance between the bottom of the grab bar and any projecting objects below it. 		
-------------------------------------------------------------------------------------------------------------------------------------------------------------------------------------------------------------------------------------------------------------------------------------------------------------------------------------------------------------------------------------------------------------------------------------------------------------------------------------------------------------------------------------------------------------------------------------------------------------------------------------------------------------------	-------------------------------------------------------------------------------------------------------------------------------------------------------------------------------------------------------------------------------------------------------------------------------------------------------------------------------------------------------------------------------------------------------------------------------------------------------------------------------------------------------------------------------------------------------------------------------------------	------------------------------------------------------------------------------------------------------------------------------------------------------------------------------------------------------------------------------------------------------------------------------------------------------------------------------------------------------------------------------------------------------------------------------------------------------------------------------------------------------------------------------------------------------------------------------------------------------------------------------------------------------------------------------------------------------------------------------------------------------------------------------------------------------------------	--	--

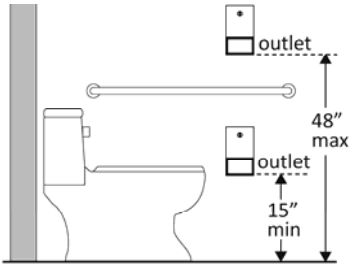
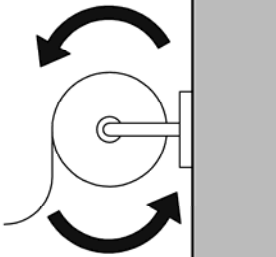
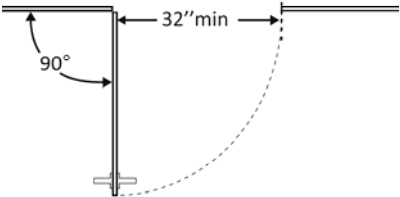
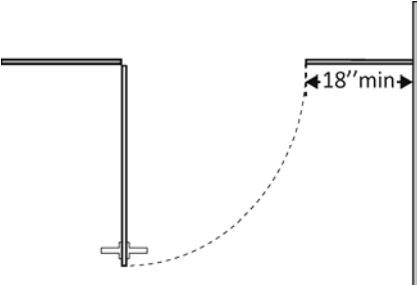
<p>3.35 If the flush control is hand operated, is the operable part located no higher than 48 inches above the floor?</p>	<p><input checked="" type="checkbox"/> Yes <input type="checkbox"/> No Measurement:</p>			
<p>3.36 If the flush control is hand operated, can it be operated with one hand and without tight grasping, pinching, or twisting of the wrist?</p> <p>Is the force required to activate the flush control no greater than 5 pounds?</p>	<p><input checked="" type="checkbox"/> Yes <input type="checkbox"/> No Measurement:</p>			
<p>3.37 Is the flush control on the open side of the water closet?</p>	<p><input checked="" type="checkbox"/> Yes <input type="checkbox"/> No</p>			
<p>3.38 Is the toilet paper dispenser located no less than 7 inches and no greater than 9 inches from the front of the water closet to the centerline of the dispenser?*</p>	<p><input checked="" type="checkbox"/> Yes <input type="checkbox"/> No Measurement:</p>			

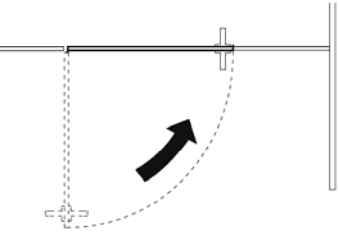
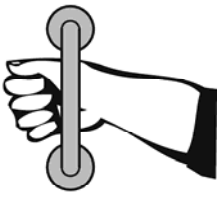
<p>3.39 Is the outlet of the dispenser:</p> <p>Located no less than 15 inches and no greater than 48 inches above the floor?</p> <p>Not located behind grab bars?</p>	<p><input checked="" type="checkbox"/> Yes <input type="checkbox"/> No</p> <p>Measurement:</p> <p><input checked="" type="checkbox"/> Yes <input type="checkbox"/> No</p>			
<p>3.40 Does the dispenser allow continuous paper flow?</p>	<p><input checked="" type="checkbox"/> Yes <input type="checkbox"/> No</p>			
<p>Toilet Compartments (Stalls) (2010 Standards – 604)</p>				
<p>3.41 Is the door opening width at least 32 inches clear, between the face of the door and the stop, when the door is open 90 degrees?</p>	<p><input checked="" type="checkbox"/> Yes <input type="checkbox"/> No</p> <p>Measurement:</p>			
<p>3.42 If there is a front approach to the pull side of the door, is there at least 18 inches of maneuvering clearance beyond the latch side plus 60 inches clear depth?*</p>	<p><input checked="" type="checkbox"/> Yes <input type="checkbox"/> No</p> <p>Measurement:</p>			

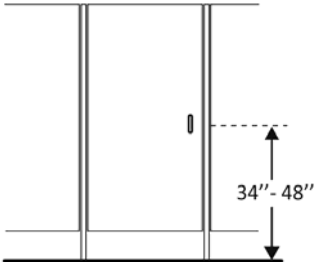
<p>3.43 Is the door self-closing?</p>	<p><input checked="" type="checkbox"/> Yes <input type="checkbox"/> No</p>			
<p>3.44 Are there door pulls on both sides of the door that are operable with one hand and do not require tight grasping pinching or twisting of the wrist?*</p>	<p><input type="checkbox"/> Yes <input checked="" type="checkbox"/> No</p>			<ul style="list-style-type: none"> • Add hardware
<p>3.45 Is the lock operable with one hand and without tight grasping, pinching or twisting of the wrist?</p>	<p><input checked="" type="checkbox"/> Yes <input type="checkbox"/> No</p>			
<p>3.46 Are the operable parts of the door hardware mounted no less than 34 inches and no greater than 48 inches above the floor?</p>	<p><input checked="" type="checkbox"/> Yes <input type="checkbox"/> No Measurement:</p>			



<p>3.47 Is the compartment at least 60 inches wide?</p>	<p><input type="checkbox"/> Yes <input checked="" type="checkbox"/> No</p> <p>Measurement:</p>		 <p>Photo #004</p>	<ul style="list-style-type: none"> • Widen compartment
<p>3.49 If the water closet is floor mounted, is the compartment at least 59 inches deep?</p>	<p><input checked="" type="checkbox"/> Yes <input type="checkbox"/> No</p> <p>Measurement:</p>			
<p>3.50 If the door swings in, is the minimum required compartment area provided beyond the swing of the door (60 inches x 56 inches if water closet is wall hung or 59 inches if water closet is floor mounted)?</p>	<p><input checked="" type="checkbox"/> Yes <input type="checkbox"/> No</p> <p>Measurement:</p>			
<p>3.51 Wall Hung Urinals installed with rim at 17in AFF? And 13-1/2in deep? With an 30in X 48in clear space?</p>	<p><input checked="" type="checkbox"/> Yes <input type="checkbox"/> No</p>			



Photo #001

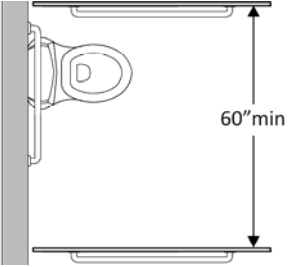

Photo #002

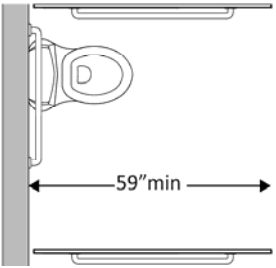
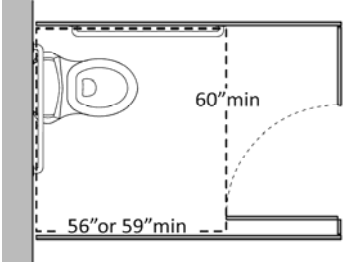

Photo #003

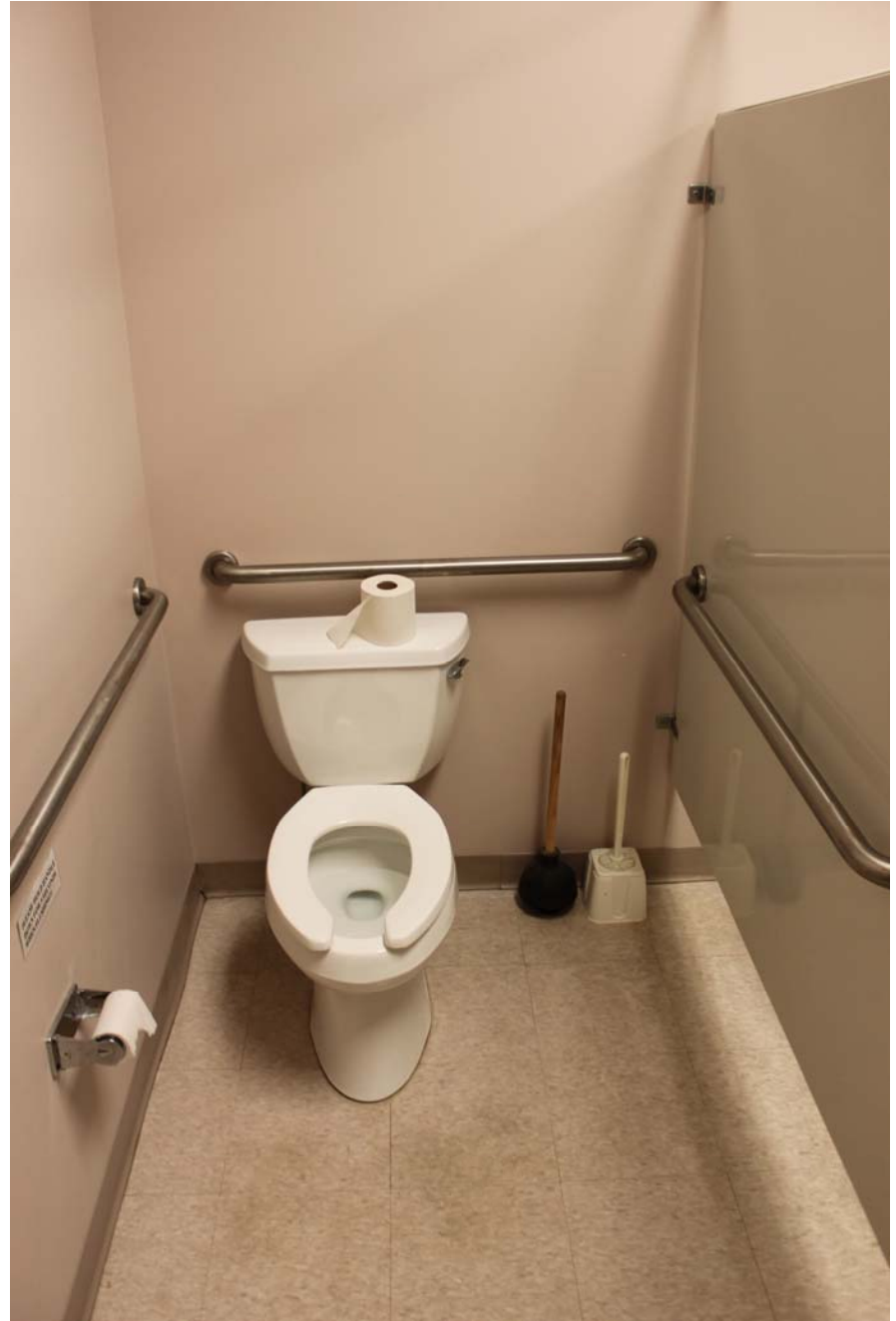

Photo #004

ADA Checklist for Readily Achievable Barrier Removal

Priority 1 – Approach & Entrance



Project Cass Count ADA Transition Plan

Building Cass County Annex - Community Corrections

Location Logansport, IN

Date 12/10/2012

Surveyors Henry Stellema & Dustin Schrougham

Contact Information 1-800-321-6959

An accessible route from site arrival points and an accessible entrance should be provided for everyone.



Institute for Human Centered Design
www.HumanCenteredDesign.org

November 2011





ADA National Network
Questions on the ADA 800-949-4232 voice/tty

www.ADAchecklist.org

This checklist was produced by the New England ADA Center, a project of the Institute for Human Centered Design and a member of the ADA National Network. This checklist was developed under a grant from the Department of Education, NIDRR grant number H133A060092-09A. However the contents do not necessarily represent the policy of the Department of Education, and you should not assume endorsement by the Federal Government.

Questions or comments on the checklist contact the New England ADA Center at 617-695-0085 voice/tty or ADAinfo@NewEnglandADA.org

For the full set of checklists, including the checklists for recreation facilities visit www.ADAchecklist.org.

Priority 1 – Approach & Entrance		Comments	Possible Solutions
Entrance (2010 Standards – 404)			
<p>1.37 Is the main entrance accessible?</p>	<input checked="" type="checkbox"/> Yes <input type="checkbox"/> No		
<p>1.38 If the main entrance is not accessible, is there an alternative accessible entrance?</p> <p>Can the alternative accessible entrance be used independently and during the same hours as the main entrance?</p>	<input checked="" type="checkbox"/> Yes <input type="checkbox"/> No <input checked="" type="checkbox"/> Yes <input type="checkbox"/> No		
<p>1.39 Do all inaccessible entrances have signs indicating the location of the nearest accessible entrance?</p>	<input type="checkbox"/> Yes <input checked="" type="checkbox"/> No		<ul style="list-style-type: none"> • Install signs

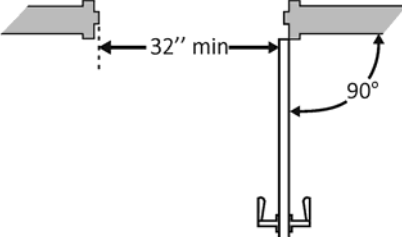
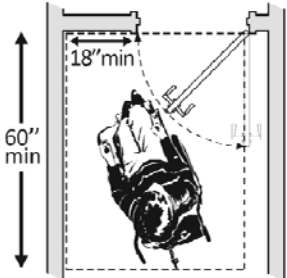
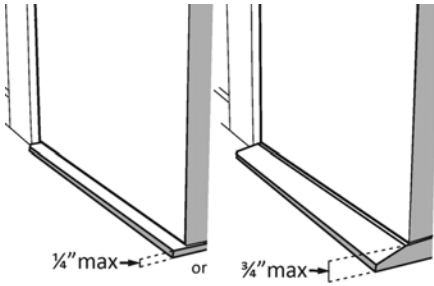
<p>1.40 If not all entrances are accessible, is there a sign at the accessible entrance with the International Symbol of Accessibility?</p>	<p><input type="checkbox"/> Yes <input checked="" type="checkbox"/> No</p>		<ul style="list-style-type: none"> • Install sign
<p>1.41 Is the clear opening width of the accessible entrance door at least 32 inches, between the face of the door and the stop, when the door is open 90 degrees?</p>	<p><input checked="" type="checkbox"/> Yes <input type="checkbox"/> No Measurement:</p>		
<p>1.42 If there is a front approach to the pull side of the door, is there at least 18 inches of maneuvering clearance beyond the latch side plus at least 60 inches clear depth?</p> <p>On both sides of the door, is the ground or floor surface of the maneuvering clearance level (no steeper than 1:48)?</p>	<p><input checked="" type="checkbox"/> Yes <input type="checkbox"/> No Measurement:</p> <p><input checked="" type="checkbox"/> Yes <input type="checkbox"/> No Measurement:</p>		
<p>1.43 Is the door threshold edge no more than ¼ inch high?</p> <p>Or</p> <p>No more than ¾ inch high if slope is beveled no steeper than 1:2?</p>	<p><input checked="" type="checkbox"/> Yes <input type="checkbox"/> No Measurement:</p> <p><input checked="" type="checkbox"/> Yes <input type="checkbox"/> No Measurement:</p>		<ul style="list-style-type: none"> • Lower counter at Main Entry

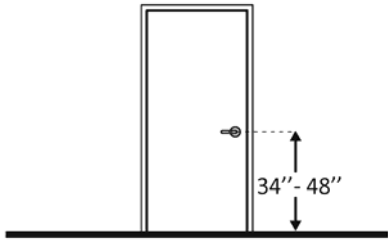
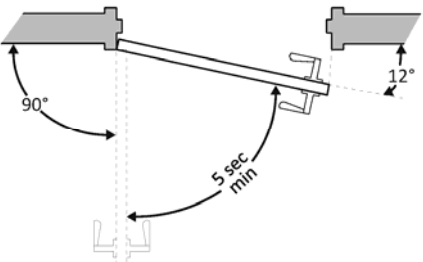
<p>Note: The first ¼ inch of the threshold may be vertical; the rest must be beveled.</p>			
<p>1.44 Is the door equipped with hardware, including locks, that is operable with one hand and does not require tight grasping, pinching, or twisting of the wrist?</p>	<p><input type="checkbox"/> Yes <input checked="" type="checkbox"/> No</p>		<ul style="list-style-type: none"> • Replace inaccessible knob with lever, loop or push hardware
<p>1.45 Are the operable parts of the door hardware no less than 34 inches and no greater than 48 inches above the floor or ground surface?</p>	<p><input checked="" type="checkbox"/> Yes <input type="checkbox"/> No Measurement:</p>		
<p>1.46 If the door has a closer, does it take at least 5 seconds to close from an open position of 90 degrees to a position of 12 degrees from the latch?</p>	<p><input type="checkbox"/> Yes <input checked="" type="checkbox"/> No Measurement:</p>		<ul style="list-style-type: none"> • Adjust closer

<p>1.48 If provided at the building entrance, are carpets or mats no higher than ½ inch thick?</p>	<p><input checked="" type="checkbox"/> Yes <input type="checkbox"/> No</p> <p>Measurement:</p>			
<p>1.49 Are edges of carpets or mats securely attached to minimize tripping hazards?</p>	<p><input checked="" type="checkbox"/> Yes <input type="checkbox"/> No</p>			

ADA Checklist for Readily Achievable Barrier Removal

Priority 2 – Access to Goods & Services

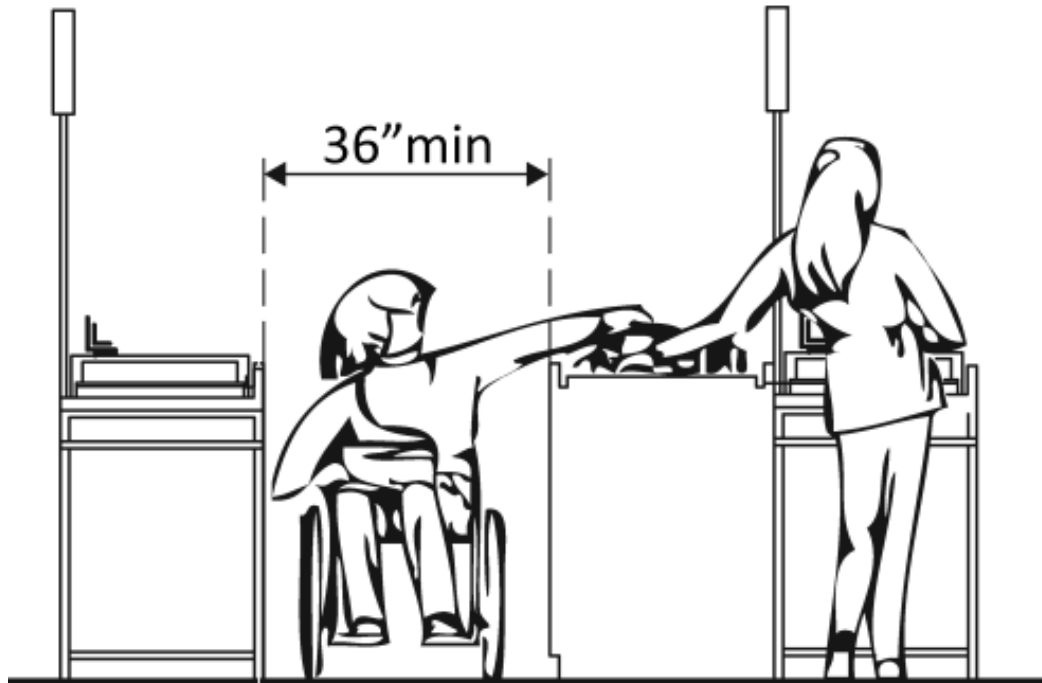

Project _____

Building _____

Location _____

Date _____

Surveyors _____

Contact Information _____

The layout of the building should allow people with disabilities to obtain goods and services and to participate in activities without assistance.



Institute for Human Centered Design
www.HumanCenteredDesign.org
November 2011





ADA National Network
Questions on the ADA 800-949-4232 voice/tty
www.ADAchecklist.org

This checklist was produced by the New England ADA Center, a project of the Institute for Human Centered Design and a member of the ADA National Network. This checklist was developed under a grant from the Department of Education, NIDRR grant number H133A060092-09A. However the contents do not necessarily represent the policy of the Department of Education, and you should not assume endorsement by the Federal Government.

Questions or comments on the checklist contact the New England ADA Center at 617-695-0085 voice/tty or ADAinfo@NewEnglandADA.org

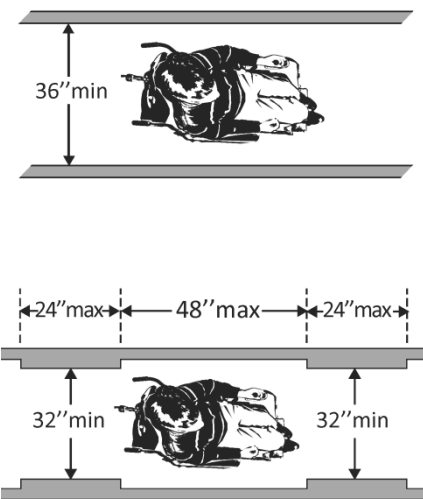

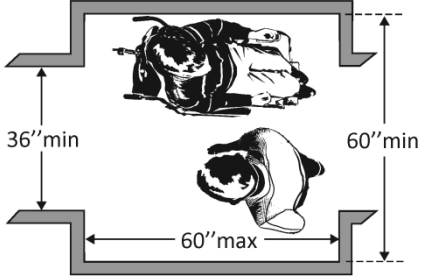
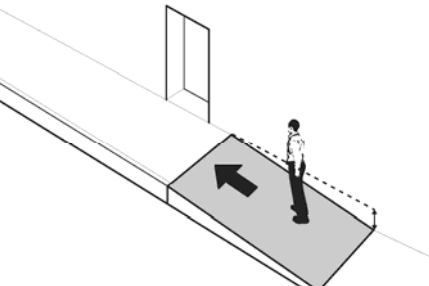
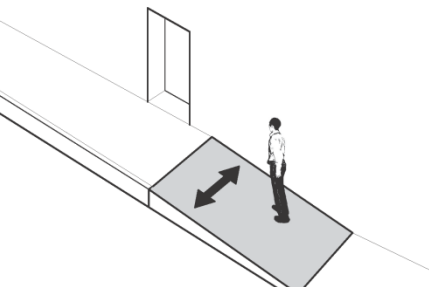
For the full set of checklists, including the checklists for recreation facilities visit www.ADAchecklist.org.

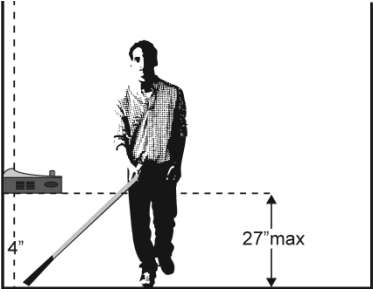
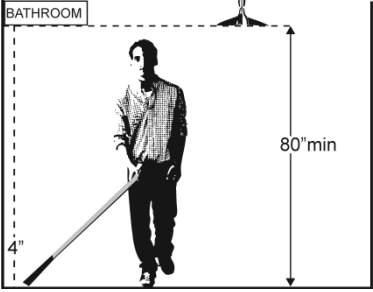
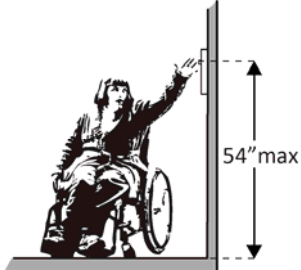

Priority 2 – Access to Goods & Services		Comments	Possible Solutions
<p>2.1 Does the accessible entrance provide direct access to the main floor, lobby and elevator?</p> <p><input checked="" type="checkbox"/> Yes <input type="checkbox"/> No</p>			
<p>Interior Accessible Route (2010 Standards – Ch.4)</p>			
<p>2.2 Are all public spaces on at least one accessible route?</p> <p><input checked="" type="checkbox"/> Yes <input type="checkbox"/> No</p>			
<p>2.3 Is the route stable, firm and slip-resistant?</p> <p><input checked="" type="checkbox"/> Yes <input type="checkbox"/> No</p>			
<p>2.4 Is the route at least 36 inches wide?</p> <p>Note: The accessible route can narrow to 32 inches min. for a max. of 24 inches. These narrower portions of the route must be at least 48 inches from each other.</p>	<p><input checked="" type="checkbox"/> Yes <input type="checkbox"/> No</p> <p>Measurement:</p>	 <p>The diagram illustrates two scenarios for wheelchair width. The top scenario shows a wheelchair between two parallel lines with a vertical double-headed arrow indicating a minimum width of 36 inches. The bottom scenario shows a wheelchair between two parallel lines with a vertical double-headed arrow indicating a minimum width of 32 inches. Above the wheelchair in this scenario, three horizontal double-headed arrows indicate maximum widths of 24 inches for the narrow sections, with a maximum of 48 inches between the narrow sections.</p>	

<p>2.5 If the route is greater than 200 feet in length and no less than 36 inches wide, is there a passing space no less than 60 x 60 inches?</p>	<p><input checked="" type="checkbox"/> Yes <input type="checkbox"/> No</p> <p>Measurement:</p>			
<p>2.6 Is the running slope no steeper than 1:20, i.e. for every inch of height change there are at least 20 inches of route run?</p>	<p><input checked="" type="checkbox"/> Yes <input type="checkbox"/> No</p> <p>Measurement:</p>			
<p>2.7 Is the cross slope no steeper than 1:48?</p>	<p><input checked="" type="checkbox"/> Yes <input type="checkbox"/> No</p> <p>Measurement:</p>			
<p>2.8 Do all objects on circulation paths through public areas, e.g. fire extinguishers, drinking fountains, signs, etc., protrude no more than 4 inches into the path? Or If an object protrudes more than 4 inches, is the bottom leading edge at 27 inches or lower above the floor?</p>	<p><input checked="" type="checkbox"/> Yes <input type="checkbox"/> No</p> <p>Measurement:</p> <p><input type="checkbox"/> Yes <input type="checkbox"/> No</p> <p>Measurement:</p>	 <p style="text-align: center;">Or</p>		

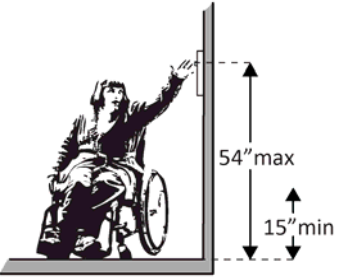
<p>Or Is the bottom leading edge at 80 inches or higher above the floor?</p>	<p><input type="checkbox"/> Yes <input type="checkbox"/> No Measurement:</p>	 <p>Or</p> 		
<p>2.9 Are there elevators or platform lifts to all public stories?*</p>	<p><input checked="" type="checkbox"/> Yes <input type="checkbox"/> No</p>			
<p>Elevators – Full Size & LULA (limited use, limited application) (2010 Standards – 407 & 408) Note: LULA elevators are often used in alterations.</p>				
<p>2.22 If there is a full size or LULA elevator, are the call buttons no higher than 54 inches above the floor?</p>	<p><input checked="" type="checkbox"/> Yes <input type="checkbox"/> No Measurement:</p>			

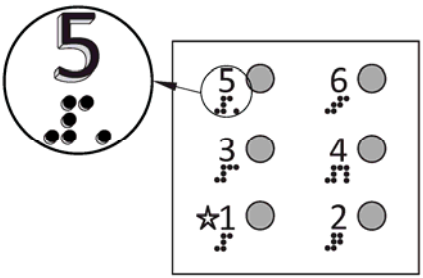
<p>2.24 If there is a LULA elevator with a swinging door:</p> <p>Is the door power-operated?</p> <p>Does the door remain open for at least 20 seconds when activated?</p>	<p><input type="checkbox"/> Yes <input checked="" type="checkbox"/> No</p> <p><input type="checkbox"/> Yes <input checked="" type="checkbox"/> No</p> <p>Time:</p>			<ul style="list-style-type: none"> • Add power operated door
<p>2.26 If there is a LULA elevator, is the interior:</p> <p>At least 51 x 51 inches with a door opening width of at least 36 inches?</p> <p>Or</p> <p>At least 54 inches deep by at least 36 inches wide with at least 15 sq. ft. of clear floor area and a door opening width of at least 32 inches?</p>	<p><input checked="" type="checkbox"/> Yes <input type="checkbox"/> No</p> <p>Measurement:</p> <p><input checked="" type="checkbox"/> Yes <input type="checkbox"/> No</p> <p>Measurement:</p>			
<p>2.27 If there is a full size or LULA elevator, are the in-car controls:</p> <p>No less than 15 inches and no greater 48 inches above the floor?</p> <p>Or</p> <p>Up to 54 inches above the floor for a parallel approach?</p>	<p><input checked="" type="checkbox"/> Yes <input type="checkbox"/> No</p> <p>Measurement:</p> <p><input type="checkbox"/> Yes <input type="checkbox"/> No</p> <p>Measurement:</p>			

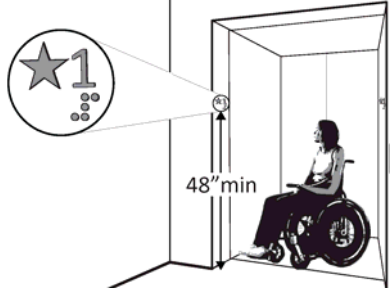
				
<p>2.28 If there is a LULA elevator, are the in-car controls centered on a side wall?</p>	<p><input checked="" type="checkbox"/> Yes <input type="checkbox"/> No</p> <p>Measurement:</p>			
<p>2.29 If there is a full size or LULA elevator:</p> <p>Are the car control buttons designated with raised characters?</p> <p>Are the car control buttons designated with Braille?</p>	<p><input checked="" type="checkbox"/> Yes <input type="checkbox"/> No</p> <p><input checked="" type="checkbox"/> Yes <input type="checkbox"/> No</p>			
<p>2.30 If there is a full size or LULA elevator, are there audible signals which sound as the car passes or is about to stop at a floor?</p>	<p><input checked="" type="checkbox"/> Yes <input type="checkbox"/> No</p>			

<p>2.31 If there is a full size or LULA elevator:</p> <p>Is there a sign on both door jambs at every floor identifying the floor?</p> <p>Is there a tactile star on both jambs at the main entry level?</p> <p>Do text characters contrast with their backgrounds?</p> <p>Are text characters raised?</p> <p>Is there Braille?</p> <p>Is the sign mounted between 48 inches to the baseline of the lowest character and 60 inches to the baseline of the highest character above the floor?*</p>	<p><input type="checkbox"/> Yes <input checked="" type="checkbox"/> No</p> <p><input type="checkbox"/> Yes <input checked="" type="checkbox"/> No</p> <p><input type="checkbox"/> Yes <input checked="" type="checkbox"/> No</p> <p><input type="checkbox"/> Yes <input checked="" type="checkbox"/> No</p> <p><input type="checkbox"/> Yes <input checked="" type="checkbox"/> No</p> <p><input type="checkbox"/> Yes <input checked="" type="checkbox"/> No</p> <p>Measurement:</p>		 <p>Photo #001</p>	<ul style="list-style-type: none"> • Add signage
---------------------------------------------------------------------------------------------------------------------------------------------------------------------------------------------------------------------------------------------------------------------------------------------------------------------------------------------------------------------------------------------------------------------------------------------------------------------------------------------------------	---------------------------------------------------------------------------------------------------------------------------------------------------------------------------------------------------------------------------------------------------------------------------------------------------------------------------------------------------------------------------------------------------------------------------------------------------------------------------------------	------------------------------------------------------------------------------------	-------------------------------------------------------------------------------------------------------	-----------------------------------------------------------------

Interior Doors – to classrooms, medical exam rooms, conference rooms, etc. (2010 Standards – 404)

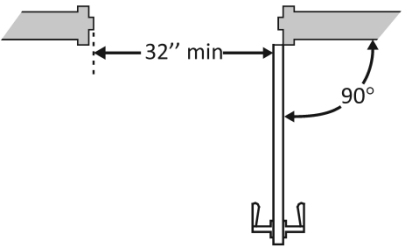
<p>2.40 Is the door opening width at least 32 inches clear, between the face of the door and the stop, when the door is open 90 degrees?</p>	<p><input checked="" type="checkbox"/> Yes <input type="checkbox"/> No</p> <p>Measurement:</p>			
-----------------------------------------------------------------------------------------------------------------------------------------------------	------------------------------------------------------------------------------------------------	--------------------------------------------------------------------------------------	--	--

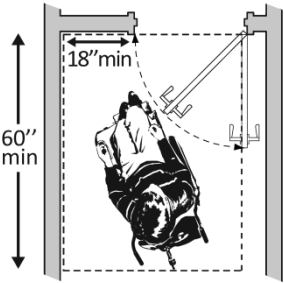
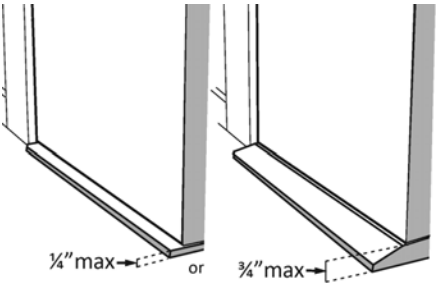
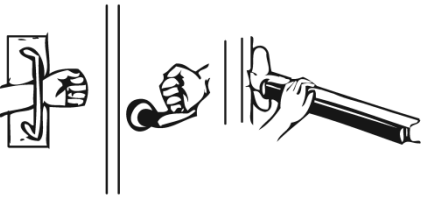
<p>2.41 If there is a front approach to the pull side of the door, is there at least 18 inches of maneuvering clearance beyond the latch side plus at least 60 inches clear depth?</p> <p>On both sides of the door, is the floor surface of the maneuvering clearance level (no steeper than 1:48)?</p>	<p><input type="checkbox"/> Yes <input checked="" type="checkbox"/> No</p> <p>Measurement:</p> <p><input checked="" type="checkbox"/> Yes <input type="checkbox"/> No</p> <p>Measurement:</p>			<ul style="list-style-type: none"> • Remove obstructions • Reconfigure walls
<p>2.42 Is the door threshold edge no more than ¼ inch high?</p> <p>Or</p> <p>No more than ¾ inch high if slope is beveled no steeper than 1:2?</p> <p>Note: The first ¼ inch of the threshold may be vertical; the rest must be beveled.</p>	<p><input checked="" type="checkbox"/> Yes <input type="checkbox"/> No</p> <p>Measurement:</p> <p><input checked="" type="checkbox"/> Yes <input type="checkbox"/> No</p> <p>Measurement:</p>			
<p>2.43 Is the door equipped with hardware that is operable with one hand and does not require tight grasping, pinching and twisting of the wrist?</p>	<p><input checked="" type="checkbox"/> Yes <input type="checkbox"/> No</p>			

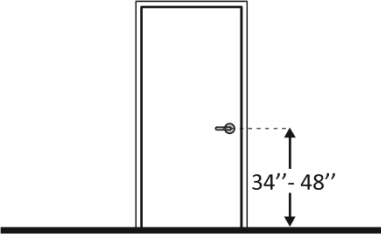
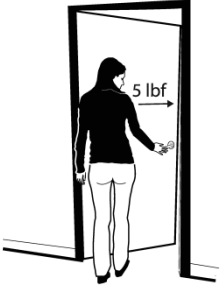
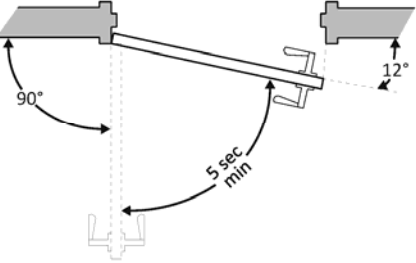
<p>2.44 Are the operable parts of the hardware no less than 34 inches and no greater than 48 inches above the floor?</p>	<p><input checked="" type="checkbox"/> Yes <input type="checkbox"/> No</p> <p>Measurement:</p>			
<p>2.45 Can the door be opened easily (5 pounds maximum force)?</p> <p>Note: You can use a pressure gauge or fish scale to measure force. If you do not have a pressure gauge or fish scale you will need to judge whether the door is easy to open.</p>	<p><input checked="" type="checkbox"/> Yes <input type="checkbox"/> No</p> <p>Measurement:</p>			
<p>2.46 If the door has a closer, does it take at least 5 seconds to close from an open position of 90 degrees to a position of 12 degrees from the latch?</p>	<p><input checked="" type="checkbox"/> Yes <input type="checkbox"/> No</p> <p>Measurement:</p>			

Controls – light switches, security and intercom systems, emergency/alarm boxes, etc. (2010 Standards – 309)

2.50 Is there a clear floor space at least 30 inches wide by at least 48 inches long for a forward or parallel approach?

Yes No

Measurement:

Are the operable parts no higher than 48 inches above the floor?*

Yes No

Measurement:

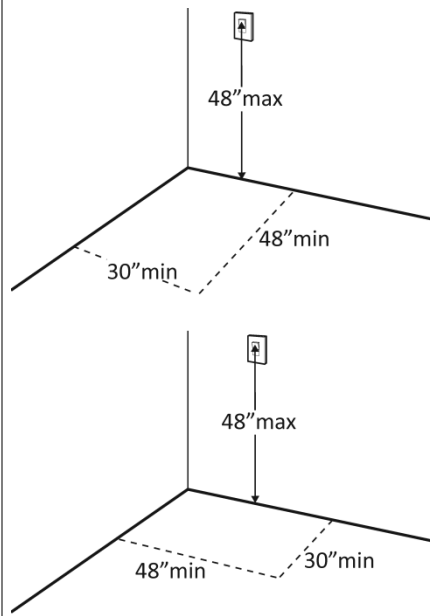

- Change height of control
-
-

*If constructed before 3/15/2012 and a parallel approach is provided, controls can be 54 inches above the floor

2.51 Can the control be operated with one hand and without tight grasping, pinching, or twisting of the wrist?

Yes No

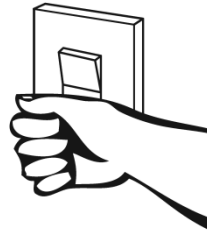

Seating: General – reception areas, waiting rooms, etc. (2010 Standards – 801)

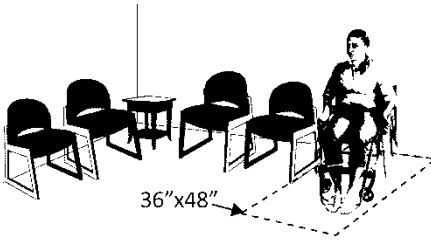
<p>2.68 Is there at least one space at least 36 inches wide by at least 48 inches long for a person in a wheelchair?</p>	<p><input checked="" type="checkbox"/> Yes <input type="checkbox"/> No Measurement:</p>	 <p>The diagram shows a waiting room with several chairs and a small table. A dashed rectangle on the floor indicates a 36-inch by 48-inch clear space. A person in a wheelchair is shown sitting within this space. An arrow points to the rectangle with the label '36"x48"'. The text 'Measurement:' is written above the diagram.</p>		
---------------------------------------------------------------------------------------------------------------------------------	---------------------------------------------------------------------------------------------	-----------------------------------------------------------------------------------------------------------------------------------------------------------------------------------------------------------------------------------------------------------------------------------------------------------------------------------------------------------------------------------------------------------------------------	--	--

Kitchens and Kitchenettes (2010 Standards – 804)

<p>2.89 If a pass through kitchen is provided, is 40" clear provided between cabinets?</p>	<p><input checked="" type="checkbox"/> Yes <input type="checkbox"/> No Measurement:</p>			
<p>2.91 Is work surface no greater than 34" AFF?</p>	<p><input checked="" type="checkbox"/> Yes <input type="checkbox"/> No</p>			
<p>2.92 Does sink comply with the requirement of items 3.21-3.27?</p>	<p><input type="checkbox"/> Yes <input checked="" type="checkbox"/> No Measurement:</p>		<p>Conference room sink is at 36" Kitchen sink is at 36-1/2"</p>	<ul style="list-style-type: none"> • Lower sink height and provide knee space underneath

<p>2.93 Does at least 50% of shelf space comply with item 2.xxx?</p>	<p><input checked="" type="checkbox"/> Yes <input type="checkbox"/> No</p> <p>Measurement:</p>			
<p>2.94 Is a 30"x42" clear space provided in front of each appliance?</p>	<p><input checked="" type="checkbox"/> Yes <input type="checkbox"/> No</p> <p>Measurement:</p>			
<p>2.95 Do appliance controls comply with reach requirements?</p>	<p><input checked="" type="checkbox"/> Yes <input type="checkbox"/> No</p>	<p>(a)</p> <p>(b)</p>		

<p>2.97 Does the location of controls require reaching across burners?</p>	<p><input checked="" type="checkbox"/> Yes <input type="checkbox"/> No</p>			<ul style="list-style-type: none"> • Replace range
<p>2.98 If oven is provided, is work surface provided on one of either side if hinged on bottom?...on latch side if side hinged?</p>	<p><input type="checkbox"/> Yes <input checked="" type="checkbox"/> No</p>			<ul style="list-style-type: none"> • Provide work surface on either side of range
<p>2.99 In a combination freezer/refrigerator, is 50% of freezer space provided at 54" AFF max?</p>	<p><input checked="" type="checkbox"/> Yes <input type="checkbox"/> No</p>			
<p>2.100 Is 30"x48" clear space provided parallel to refrigerator?</p>	<p><input checked="" type="checkbox"/> Yes <input type="checkbox"/> No</p>			
<p>Holding Cells (2010 Standards –807)</p>				
<p>2.103 In holding cells with mobility features, is 30"x48" clear space provided on at least one side of bed?</p>	<p><input checked="" type="checkbox"/> Yes <input type="checkbox"/> No Measurement:</p>			
<p>2.104 Is a 60" turn around provided?</p>	<p><input checked="" type="checkbox"/> Yes <input type="checkbox"/> No</p>			

2.105 If toilet facilities are provided in holding cells, are an accessible toilet, sink and shower/tub provided?	<input checked="" type="checkbox"/> Yes <input type="checkbox"/> No			
--------------------------------------------------------------------------------------------------------------------------	---------------------------------------------------------------------	--	--	--

The ADA Checklist for Readily Achievable Barrier Removal

Priority 3 - Toilet Rooms

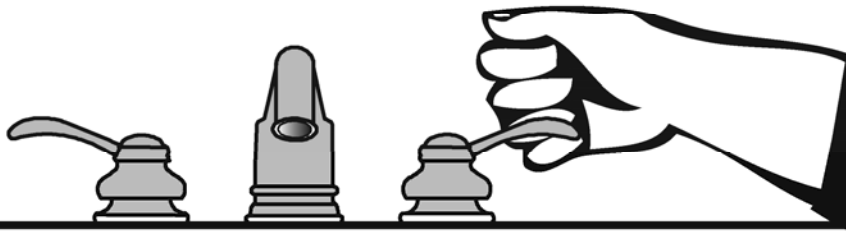

Project _____

Building _____

Location _____

Date _____

Surveyors _____

Contact Information _____

When toilet rooms are open to the public they should be accessible to people with disabilities.



Institute for Human Centered Design
www.HumanCenteredDesign.org
November 2011





ADA National Network
Questions on the ADA 800-949-4232 voice/tty
www.ADAchecklist.org

This checklist was produced by the New England ADA Center, a project of the Institute for Human Centered Design and a member of the ADA National Network. This checklist was developed under a grant from the Department of Education, NIDRR grant number H133A060092-09A. However the contents do not necessarily represent the policy of the Department of Education, and you should not assume endorsement by the Federal Government.

Questions or comments on the checklist contact the New England ADA Center at 617-695-0085 voice/tty or ADAinfo@NewEnglandADA.org

For the full set of checklists, including the checklists for recreation facilities visit www.ADAchecklist.org.

Priority 3 – Toilet Rooms			Comments	Possible Solutions
<p>3.1 If toilet rooms are available to the public, is at least one toilet room accessible? (Either one for each sex, or one unisex.)</p>	<p><input type="checkbox"/> Yes <input checked="" type="checkbox"/> No</p>		<p>All restrooms are entirely non-compliant with the exception of the corrections area toilets which are compliant. However, the correction showers are too small.</p>  <p>Photo #002</p>	<ul style="list-style-type: none"> • Reconfigure toilet rooms
<p>3.2 Are there signs at inaccessible toilet rooms that give directions to accessible toilet rooms?</p>	<p><input type="checkbox"/> Yes <input checked="" type="checkbox"/> No</p>			<ul style="list-style-type: none"> • Install signs

<p>3.3 If not all toilet rooms are accessible, is there a sign at the accessible toilet room with the International Symbol of Accessibility?</p>	<p><input type="checkbox"/> Yes <input checked="" type="checkbox"/> No</p>			<ul style="list-style-type: none"> • Install signs
---------------------------------------------------------------------------------------------------------------------------------------------------------	----------------------------------------------------------------------------	-------------------------------------------------------------------------------------	--	-------------------------------------------------------------------

Accessible Route (2010 Standards – Chapter 4)

<p>3.4 Is there a route to the accessible toilet room(s) that does not include the use of stairs?</p> <p>Is the route accessible? (See Priority 2 Interior Accessible Route for specifics.)</p>	<p><input checked="" type="checkbox"/> Yes <input type="checkbox"/> No</p> <p><input checked="" type="checkbox"/> Yes <input type="checkbox"/> No</p>			
--------------------------------------------------------------------------------------------------------------------------------------------------------------------------------------------------------	-------------------------------------------------------------------------------------------------------------------------------------------------------	--	--	--

ADA Checklist for Readily Achievable Barrier Removal

Priority 4 – Additional Access

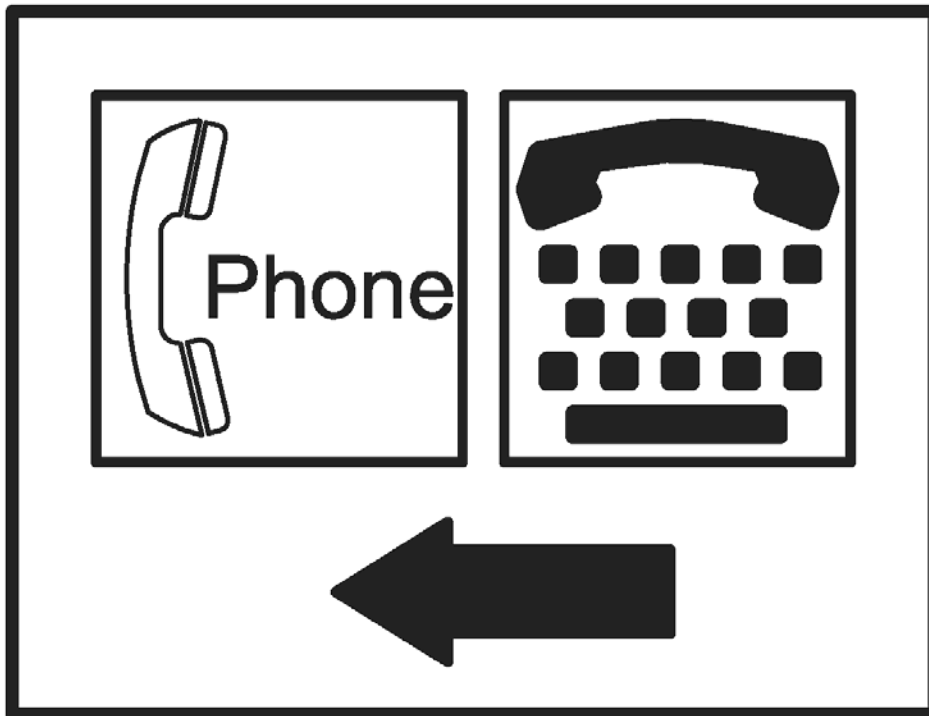

Project _____

Building _____

Location _____

Date _____

Surveyors _____

Contact Information _____

Amenities such as drinking fountains and public telephones should be accessible to people with disabilities.



Institute for Human Centered Design
www.HumanCenteredDesign.org
November 2011







ADA National Network
Questions on the ADA 800-949-4232 voice/tty
www.ADAchecklist.org

This checklist was produced by the New England ADA Center, a project of the Institute for Human Centered Design and a member of the ADA National Network. This checklist was developed under a grant from the Department of Education, NIDRR grant number H133A060092-09A. However the contents do not necessarily represent the policy of the Department of Education, and you should not assume endorsement by the Federal Government.

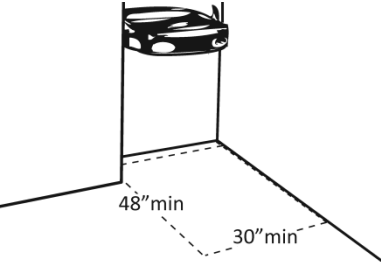

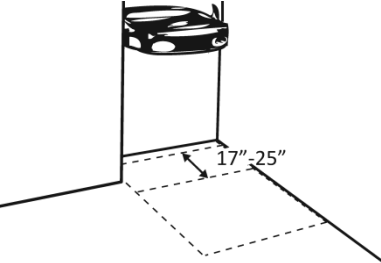
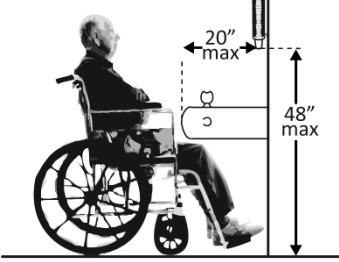
Questions or comments on the checklist contact the New England ADA Center at 617-695-0085 voice/tty or ADAinfo@NewEnglandADA.org

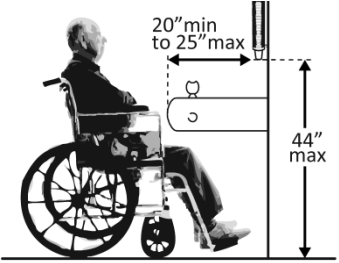

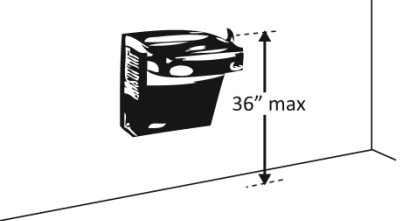
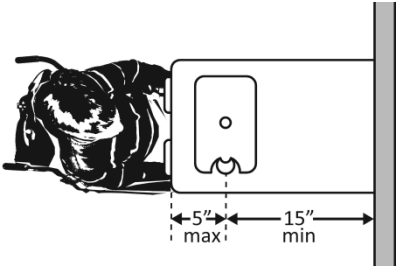
For the full set of checklists, including the checklists for recreation facilities visit www.ADAchecklist.org.

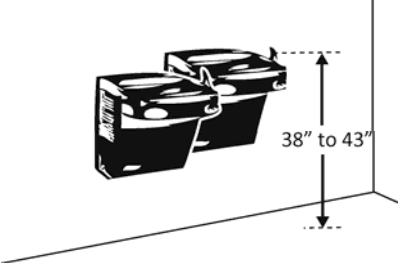
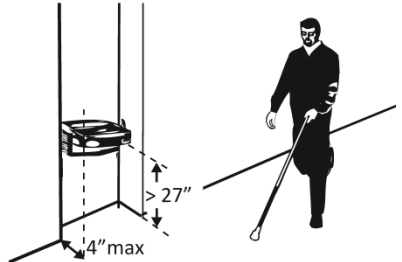
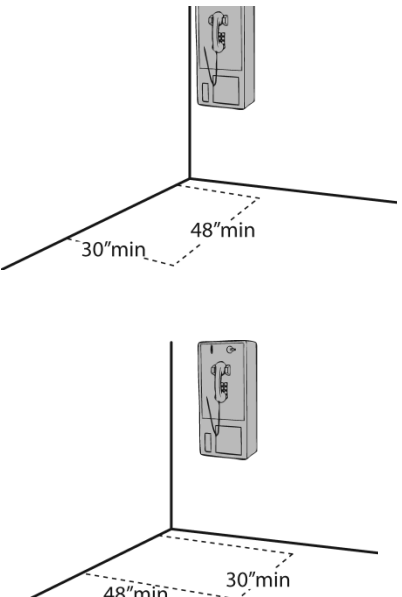
Priority 4 – Additional Access		Comments	Possible Solutions	
Drinking Fountains (2010 Standards – 602)				
<p>4.1 Does at least one drinking fountain have a clear floor space at least 30 inches wide x at least 48 inches long centered in front of it for a forward approach?*</p>	<input type="checkbox"/> Yes <input checked="" type="checkbox"/> No	<p>Measurement:</p> 	 <p>Photo #003</p>	<ul style="list-style-type: none"> • Replace drinking fountain
<p>4.2 If there is a forward approach, do no less than 17 inches and no greater than 25 inches of the clear floor space extend under the drinking fountain?</p>	<input type="checkbox"/> Yes <input checked="" type="checkbox"/> No	<p>Measurement:</p> 		
<p>4.3 If the drinking fountain is no deeper than 20 inches, are the operable parts no higher than 48 inches above the floor?</p>	<input type="checkbox"/> Yes <input checked="" type="checkbox"/> No	<p>Measurement:</p> 		

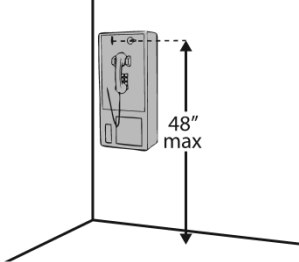
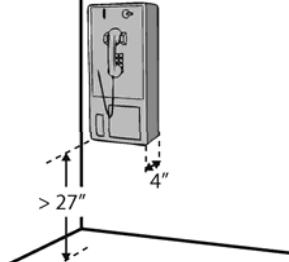
<p>4.4 If the drinking fountain is no less than 20 inches and no greater than 25 inches deep, are the operable parts no higher than 44 inches above the floor?</p>	<p><input type="checkbox"/> Yes <input checked="" type="checkbox"/> No</p> <p>Measurement:</p>			
<p>4.5 Can the control be operated with one hand and without tight grasping, pinching or twisting of the wrist?</p> <p>Is the force required to activate the control no more than 5 pounds?</p>	<p><input type="checkbox"/> Yes <input checked="" type="checkbox"/> No</p> <p><input type="checkbox"/> Yes <input type="checkbox"/> No</p> <p>Measurement:</p>			
<p>4.6 Is the spout outlet no higher than 36 inches above the floor?</p>	<p><input type="checkbox"/> Yes <input checked="" type="checkbox"/> No</p> <p>Measurement:</p>			
<p>4.7 Is the spout:</p> <p>At least 15 inches from the rear of the drinking fountain?</p> <p>No more than 5 inches from the front of the drinking fountain?</p>	<p><input type="checkbox"/> Yes <input checked="" type="checkbox"/> No</p> <p>Measurement:</p> <p><input type="checkbox"/> Yes <input checked="" type="checkbox"/> No</p> <p>Measurement:</p>			

<p>4.8 If there is more than one drinking fountain, is there at least one for standing persons?</p> <p>Is the spout outlet no lower than 38 inches and no higher than 43 inches above the floor?</p>	<p><input type="checkbox"/> Yes <input checked="" type="checkbox"/> No</p> <p><input type="checkbox"/> Yes <input checked="" type="checkbox"/> No</p> <p>Measurement:</p>			
<p>4.9 If the leading (bottom) edge of the fountain is higher than 27 inches above the floor, does the front of the fountain protrude no more than 4 inches into the circulation path?</p>	<p><input type="checkbox"/> Yes <input type="checkbox"/> No</p> <p>Measurement:</p>			
<p>Public Telephones (2010 Standards – 704) TTY's are devices that employ interactive text-based communication through the transmission of coded signals across the telephone network. They are mainly used by people who are deaf and/or cannot speak.</p>				
<p>4.10 Does at least one telephone have a clear floor space at least 30 inches wide x at least 48 inches long for a parallel or forward approach?</p>	<p><input checked="" type="checkbox"/> Yes <input type="checkbox"/> No</p>			

<p>4.11 Is the highest operable part of the telephone no higher than 48 inches above the floor?</p>	<p><input type="checkbox"/> Yes <input checked="" type="checkbox"/> No</p> <p>Measurement:</p>		<ul style="list-style-type: none"> • Adjust telephone
<p>4.12 If the leading (bottom) edge of the telephone is higher than 27 inches above the floor, does the front of the telephone protrude no more than 4 inches into the circulation path?</p>	<p><input checked="" type="checkbox"/> Yes <input type="checkbox"/> No</p> <p>Measurement:</p>		
<p>4.13 Does at least one telephone have a volume control?</p>	<p><input type="checkbox"/> Yes <input checked="" type="checkbox"/> No</p>		<ul style="list-style-type: none"> • Install volume control
<p>4.14 Is the volume control identified by a pictogram of a telephone handset with radiating sound waves?</p>	<p><input type="checkbox"/> Yes <input checked="" type="checkbox"/> No</p>		<ul style="list-style-type: none"> • Add pictogram

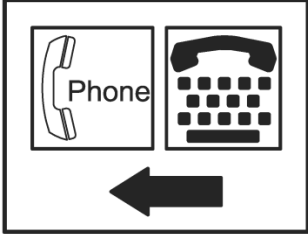
<p>4.15 Does at least one telephone have a TTY?</p>	<p><input type="checkbox"/> Yes <input checked="" type="checkbox"/> No</p>		<ul style="list-style-type: none"> • Install TTY
<p>4.16 Is the touch surface of the TTY keypad at least 34 inches above the floor?</p>	<p><input type="checkbox"/> Yes <input checked="" type="checkbox"/> No Measurement:</p>		
<p>4.17 Is the TTY identified by the International Symbol of TTY?</p>	<p><input type="checkbox"/> Yes <input checked="" type="checkbox"/> No</p>		<ul style="list-style-type: none"> • Add symbol
<p>4.18 Do signs that provide direction to public telephones also provide direction to the TTY?</p>	<p><input type="checkbox"/> Yes <input checked="" type="checkbox"/> No</p>		<ul style="list-style-type: none"> • Add signs



<p>4.19 Do telephones that do not have a TTY provide direction to the TTY?</p>	<p><input type="checkbox"/> Yes <input checked="" type="checkbox"/> No</p>				<ul style="list-style-type: none"> • Add signs
---------------------------------------------------------------------------------------	----------------------------------------------------------------------------	-------------------------------------------------------------------------------------	-------------------------------------------------------------------------------------	--	---------------------------------------------------------------



Photo #001

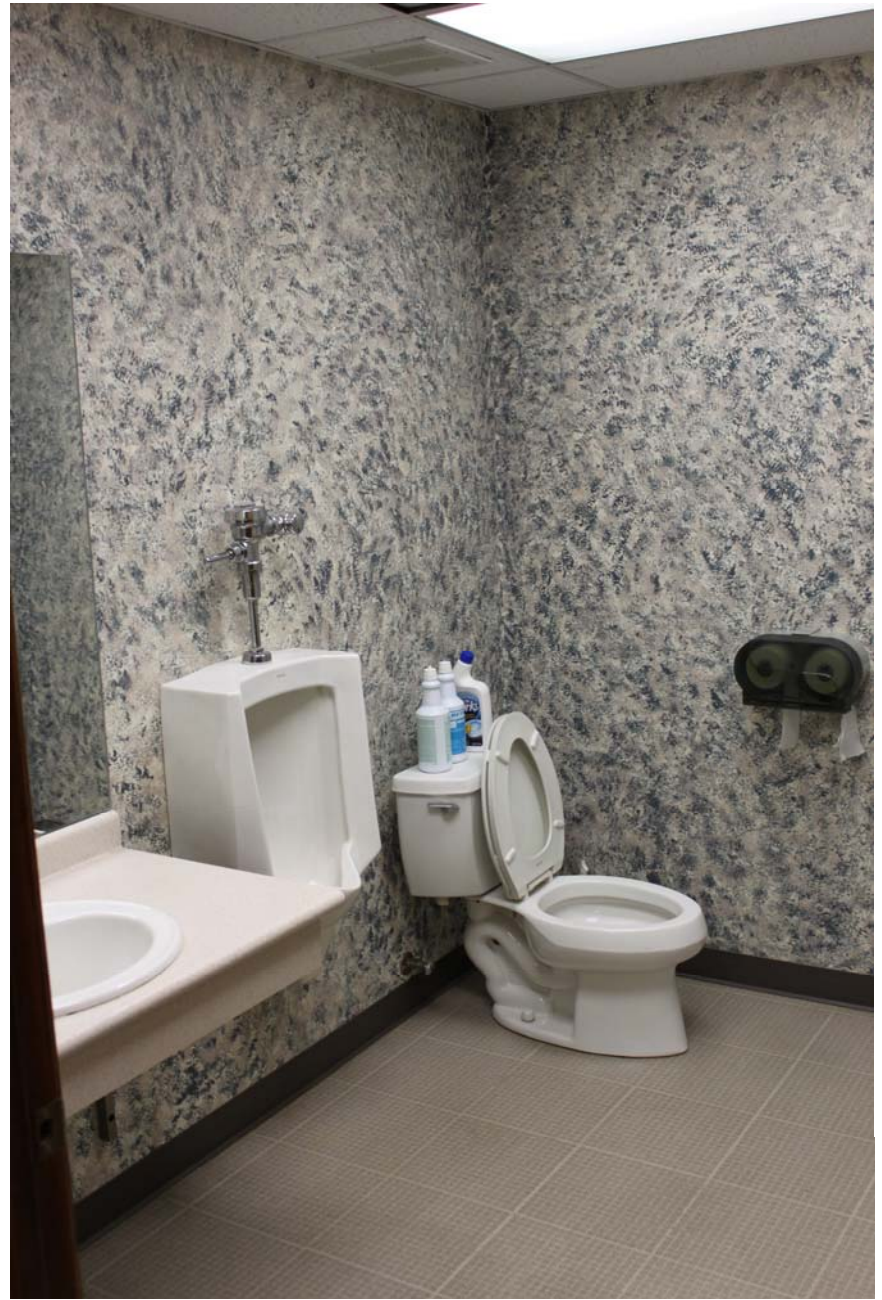

Photo #002



Photo #003



Staffing Resources

Counter is too high – Lower to 34". Sink is non-compliant – Provide knee space.



Staffing Resources

Drinking Fountain is non-compliant – Replace with ADA compliant DF. Restrooms are entirely non-compliant – Remodel restrooms as single user toilet to make compliant.



County Health Department

The County Health Department building is compliant with the Lobby restroom. Staff restrooms are non-compliant but accommodation has been provided in the lobby.



All Phase Building

General circulation through the All Phase building is fine; however the restroom is entirely non-compliant. Remodel the restrooms to create a single user ADA compliant restroom.



Georgetown Pavilion

No designated handicap parking existed – Add signage and striping. No accessible path from sidewalk to pavilion – Add sidewalk. Sidewalk leading to lakefront boardwalk is of such a slope to qualify as a ramp – Add handrails along both sides.



Adamsboro Pavilion

Handicap parking while provided is non-compliant – Add striping and signage. No accessible route from Handicap Parking to Pavilion itself – Add sidewalk.



Gate House

The Gate House is entirely non-compliant with ADA Standards.



Recreation Building

The kitchenette in the Recreation Building has several issues:

- 1) Counter is too high at 36"
- 2) Appliances are non-compliant.
- 3) Sink is inaccessible.



Recreation Building

The Recreation Building toilet is entirely non-compliant.



Bathhouse

The newer Bathhouse building is the most compliant facility on site. With a few modifications, it can be brought in line. Accessible parking is available, but needs signage. Pathway from parking to bathhouse is accessible, but its slope makes it a ramp and requires handrails on both sides.



Within the bathhouse, the toilets are largely compliant however the toilet paper is installed in a non-compliant location. It needs to be move to below the handrail. The handicap stall needs door pulls added to each face of the door. Urinals are mounted too high.



The mirrors are mounted at a non-compliant height. They must be at 40" max.

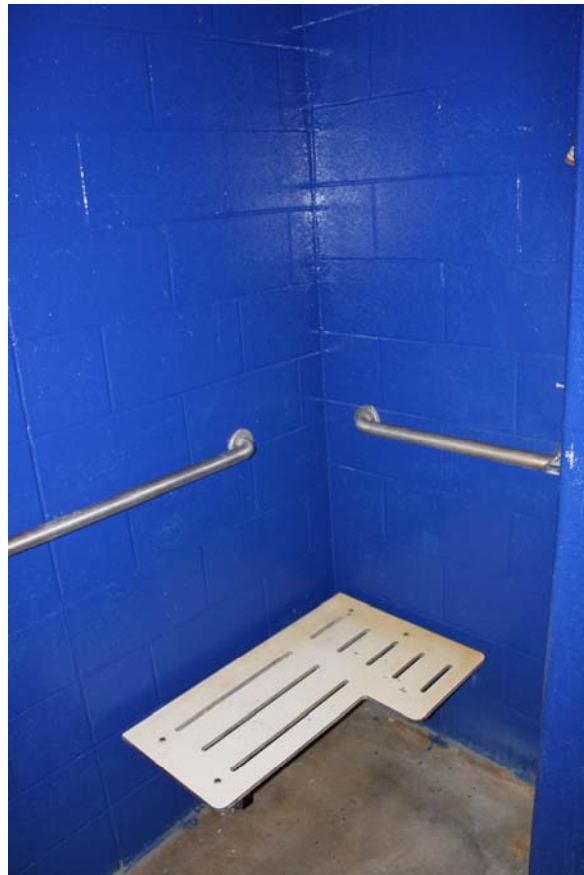

The shower head and controls while mounted on the correct wall are too close to the adjacent wall. The grab bars are in a non-compliant configuration.



Camp Store

The camp store needs accessible parking and an accessible route to the front door. The interior layout of the space needs to be reconfigured to accommodate the disabled. The restrooms are entirely non-compliant.



ADA Checklist for Readily Achievable Barrier Removal

Priority 1 – Approach & Entrance



Project Cass County ADA Transition Plan

Building Memorial Home

Location Logansport, IN

Date 12/10/2012

Surveyors Henry Stellema & Dustin Schrougham

Contact Information 1-800-321-6959

An accessible route from site arrival points and an accessible entrance should be provided for everyone.



Institute for Human Centered Design
www.HumanCenteredDesign.org

November 2011





ADA National Network
Questions on the ADA 800-949-4232 voice/tty

www.ADAchecklist.org

This checklist was produced by the New England ADA Center, a project of the Institute for Human Centered Design and a member of the ADA National Network. This checklist was developed under a grant from the Department of Education, NIDRR grant number H133A060092-09A. However the contents do not necessarily represent the policy of the Department of Education, and you should not assume endorsement by the Federal Government.

Questions or comments on the checklist contact the New England ADA Center at 617-695-0085 voice/tty or ADAinfo@NewEnglandADA.org

For the full set of checklists, including the checklists for recreation facilities visit www.ADAchecklist.org.

Priority 1 – Approach & Entrance		Comments	Possible Solutions											
<p>1.1 Is there at least one route from site arrival points (parking, passenger loading zones, public sidewalks and public transportation stops) that does not require the use of stairs?</p> <p><input type="checkbox"/> Yes <input checked="" type="checkbox"/> No</p> <p>If yes, location of route:</p>	 <p>Photo #001</p>	<ul style="list-style-type: none"> • Add a ramp 												
<p>Parking (2010 Standards – 208 & 502) Note: Accessible parking spaces should be identified by size, access aisle and signage.</p>														
<p>1.2 If parking is provided for the public, are an adequate number of accessible spaces provided?</p> <p><input type="checkbox"/> Yes <input checked="" type="checkbox"/> No</p> <p>Total #:</p> <p>Accessible #:</p>	<table border="1"> <thead> <tr> <th>Total Spaces</th> <th>Accessible Spaces</th> </tr> </thead> <tbody> <tr> <td>1 - 25</td> <td>1</td> </tr> <tr> <td>26 - 50</td> <td>2</td> </tr> <tr> <td>51 - 75</td> <td>3</td> </tr> <tr> <td>76 - 100</td> <td>4</td> </tr> <tr> <td colspan="2">100+ see 2010 Standards 208.2</td> </tr> </tbody> </table>	Total Spaces	Accessible Spaces	1 - 25	1	26 - 50	2	51 - 75	3	76 - 100	4	100+ see 2010 Standards 208.2		<ul style="list-style-type: none"> • Provide accessible parking
Total Spaces	Accessible Spaces													
1 - 25	1													
26 - 50	2													
51 - 75	3													
76 - 100	4													
100+ see 2010 Standards 208.2														
<p>Entrance (2010 Standards – 404)</p>														
<p>1.37 Is the main entrance accessible?</p> <p><input type="checkbox"/> Yes <input checked="" type="checkbox"/> No</p>	 <p>Photo #002</p>	<ul style="list-style-type: none"> • Redesign to make it accessible 												

ADA Checklist for Readily Achievable Barrier Removal

Priority 2 – Access to Goods & Services

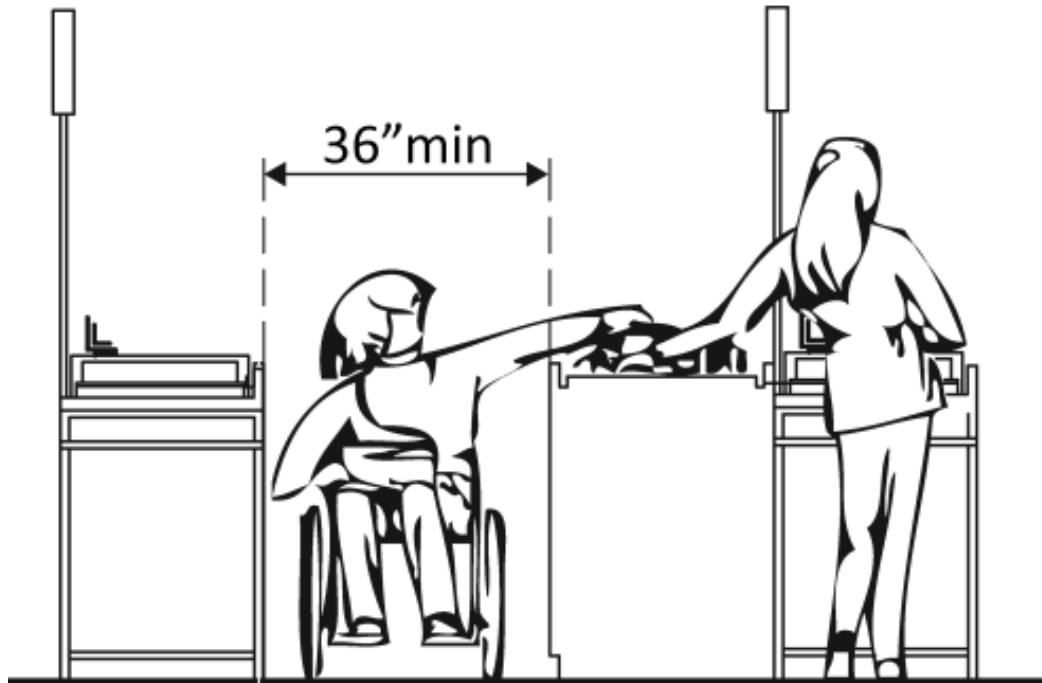

Project _____

Building _____

Location _____

Date _____

Surveyors _____

Contact Information _____

The layout of the building should allow people with disabilities to obtain goods and services and to participate in activities without assistance.



Institute for Human Centered Design
www.HumanCenteredDesign.org
November 2011



ADA National Network
Questions on the ADA 800-949-4232 voice/tty
www.ADAchecklist.org

This checklist was produced by the New England ADA Center, a project of the Institute for Human Centered Design and a member of the ADA National Network. This checklist was developed under a grant from the Department of Education, NIDRR grant number H133A060092-09A. However the contents do not necessarily represent the policy of the Department of Education, and you should not assume endorsement by the Federal Government.

Questions or comments on the checklist contact the New England ADA Center at 617-695-0085 voice/tty or ADAinfo@NewEnglandADA.org

For the full set of checklists, including the checklists for recreation facilities visit www.ADAchecklist.org.

Priority 2 – Access to Goods & Services		Comments	Possible Solutions
2.1	Does the accessible entrance provide direct access to the main floor, lobby and elevator? <input checked="" type="checkbox"/> Yes <input type="checkbox"/> No		
Interior Accessible Route (2010 Standards – Ch.4)			
2.2	Are all public spaces on at least one accessible route? <input type="checkbox"/> Yes <input checked="" type="checkbox"/> No		<ul style="list-style-type: none"> • Create accessible route

The ADA Checklist for Readily Achievable Barrier Removal

Priority 3 - Toilet Rooms

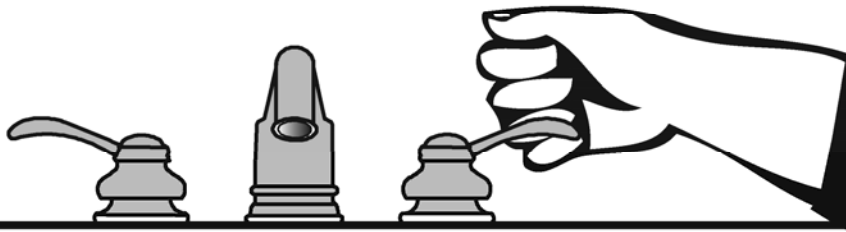

Project _____

Building _____

Location _____

Date _____

Surveyors _____

Contact Information _____

When toilet rooms are open to the public they should be accessible to people with disabilities.



Institute for Human Centered Design
www.HumanCenteredDesign.org
November 2011





ADA National Network
Questions on the ADA 800-949-4232 voice/tty
www.ADAchecklist.org

This checklist was produced by the New England ADA Center, a project of the Institute for Human Centered Design and a member of the ADA National Network. This checklist was developed under a grant from the Department of Education, NIDRR grant number H133A060092-09A. However the contents do not necessarily represent the policy of the Department of Education, and you should not assume endorsement by the Federal Government.

Questions or comments on the checklist contact the New England ADA Center at 617-695-0085 voice/tty or ADAinfo@NewEnglandADA.org

For the full set of checklists, including the checklists for recreation facilities visit www.ADAchecklist.org.

Priority 3 – Toilet Rooms			Comments	Possible Solutions
<p>3.1 If toilet rooms are available to the public, is at least one toilet room accessible? (Either one for each sex, or one unisex.)</p>	<p><input type="checkbox"/> Yes <input checked="" type="checkbox"/> No</p>		<p>Restrooms are entirely non-compliant.</p>  <p>Photo #003</p>	<ul style="list-style-type: none"> • Reconfigure toilet rooms • Combine toilet rooms to create one unisex accessible toilet room
<p>3.2 Are there signs at inaccessible toilet rooms that give directions to accessible toilet rooms?</p>	<p><input type="checkbox"/> Yes <input checked="" type="checkbox"/> No</p>			<ul style="list-style-type: none"> • Install signs

<p>3.3 If not all toilet rooms are accessible, is there a sign at the accessible toilet room with the International Symbol of Accessibility?</p>	<p><input type="checkbox"/> Yes <input checked="" type="checkbox"/> No</p>			<ul style="list-style-type: none"> • Install sign
---------------------------------------------------------------------------------------------------------------------------------------------------------	----------------------------------------------------------------------------	-------------------------------------------------------------------------------------	--	------------------------------------------------------------------

Accessible Route *(2010 Standards – Chapter 4)*

<p>3.4 Is there a route to the accessible toilet room(s) that does not include the use of stairs?</p> <p>Is the route accessible? (See Priority 2 Interior Accessible Route for specifics.)</p>	<p><input checked="" type="checkbox"/> Yes <input type="checkbox"/> No</p> <p><input checked="" type="checkbox"/> Yes <input type="checkbox"/> No</p>			
--------------------------------------------------------------------------------------------------------------------------------------------------------------------------------------------------------	-------------------------------------------------------------------------------------------------------------------------------------------------------	--	--	--



Photo #001



Photo #002



Photo #003