



Capital Cities

INSTITUTIONAL INVESTING MADE PERSONAL



State of Indiana Public Employees Deferred Compensation 457/401(a) Plans
Performance & Evaluation Annual Report
For Year Ending December 31, 2018

**VANGUARD INSTITUTIONAL INDEX
STYLE: LARGE CAP CORE – PASSIVE
YEAR ENDED DECEMBER 31, 2018**

Organization		Vanguard Funds
Product Name	Institutional Index	
Fund Inception	August 31, 1976	
Ownership Structure	Client-owned Mutual Fund Company	
Firm Information	Located in Valley Forge, Pennsylvania; Founded in 1975 with over \$5.1 trillion in assets under management.	
Investment Strategy	Fund seeks to mirror holdings and portfolio characteristics of the S&P 500 Index.	
Key Professionals	Donald Butler and Michelle Louie	
Index	S&P 500	
Assets In Product	\$217 billion	
Fees	2 bps	
Vehicle Type	Mutual Fund (VIII X)	

Domestic Equity Style Map
for 5 Years Ended December 31, 2018

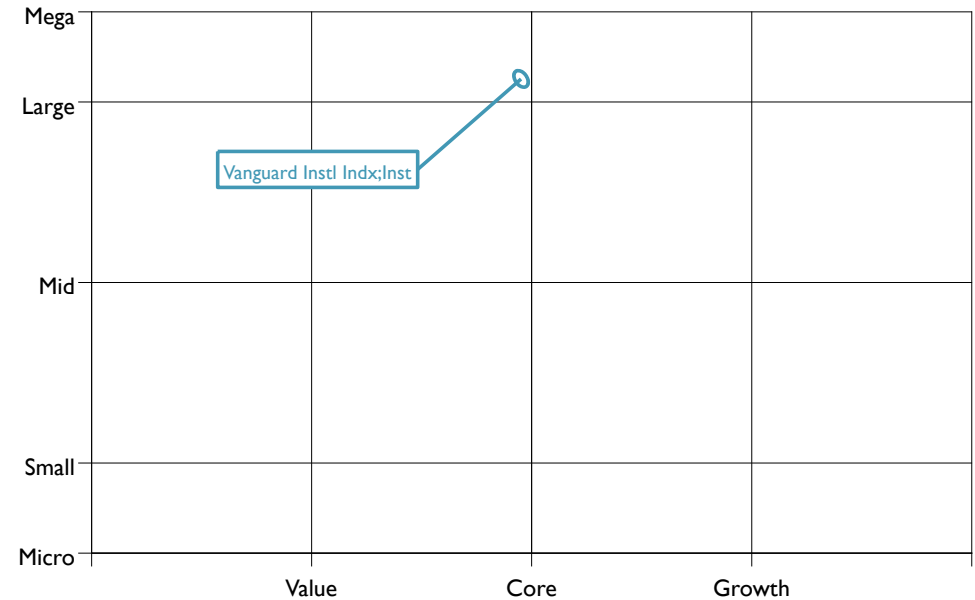

**Rolling 12 Quarter Scatter Chart for 5 Years
Ended December 31, 2018**

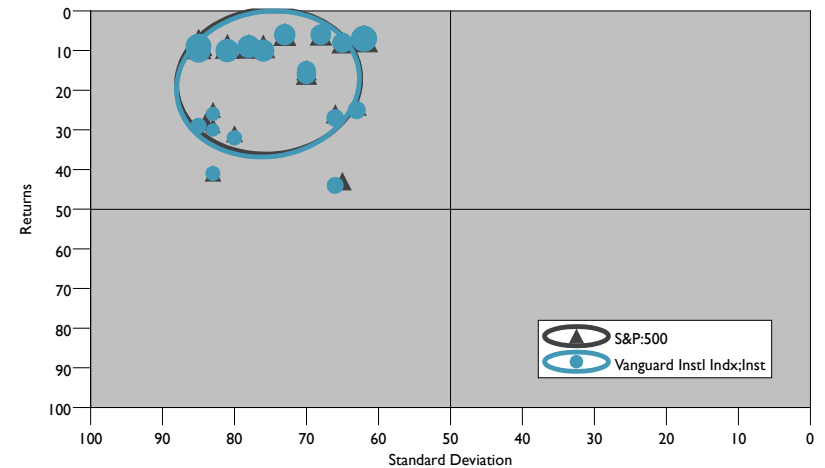

	December 31, 2018 Market Value	% of Plan Assets
Vanguard Institutional Index	\$110,258,982	9.2%



VANGUARD INSTITUTIONAL INDEX STYLE: LARGE CAP CORE – PASSIVE YEAR ENDED DECEMBER 31, 2018

Returns for Calendar Years
10 Years Ended December 31, 2018
Group: Callan Large Cap Core Mutual Funds

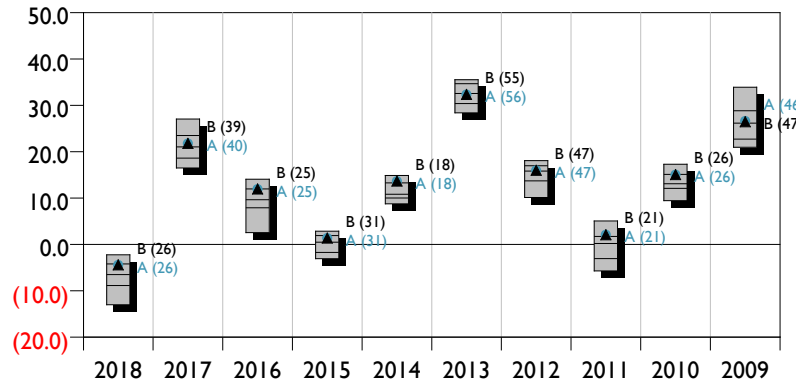

10th Percentile	(2.22)	27.05	14.07	2.86	14.88	35.54	18.08	5.09	17.32	33.92
25th Percentile	(4.21)	23.49	11.98	1.91	13.28	34.68	16.98	1.74	15.12	28.83
Median	(6.52)	21.05	9.66	0.49	10.83	32.57	15.81	0.21	13.07	26.18
75th Percentile	(8.88)	18.60	7.91	(1.74)	10.01	30.39	13.70	(3.06)	12.11	22.73
90th Percentile	(13.00)	16.49	2.55	(3.07)	8.77	28.41	10.13	(5.70)	9.45	20.97

Returns for 12 Quarter Rolling Periods
5 Years Ended December 31, 2018
Group: Callan Large Cap Core Mutual Funds

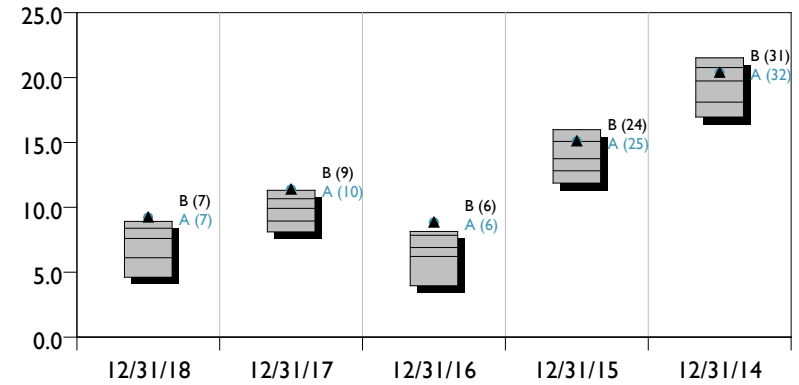

10th Percentile	8.92	11.32	8.15	15.99	21.53
25th Percentile	8.39	10.66	7.84	15.08	20.76
Median	7.60	9.92	6.90	13.75	19.74
75th Percentile	6.12	8.94	6.21	12.82	18.10
90th Percentile	4.62	8.11	3.96	11.88	16.96

Statistics relative to S&P:500
for 5 Years Ended December 31, 2018
Group: Callan Large Cap Core Mutual Funds

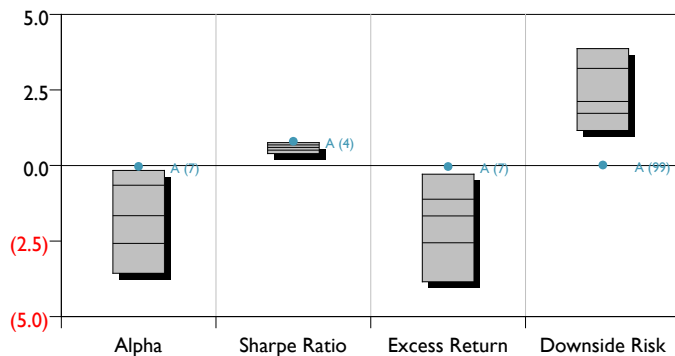

10th Percentile	(0.16)	0.76	(0.29)	3.87
25th Percentile	(0.65)	0.68	(1.11)	3.21
Median	(1.66)	0.60	(1.67)	2.12
75th Percentile	(2.58)	0.51	(2.56)	1.73
90th Percentile	(3.56)	0.40	(3.85)	1.16

Statistics relative to S&P:500
for 5 Years Ended December 31, 2018

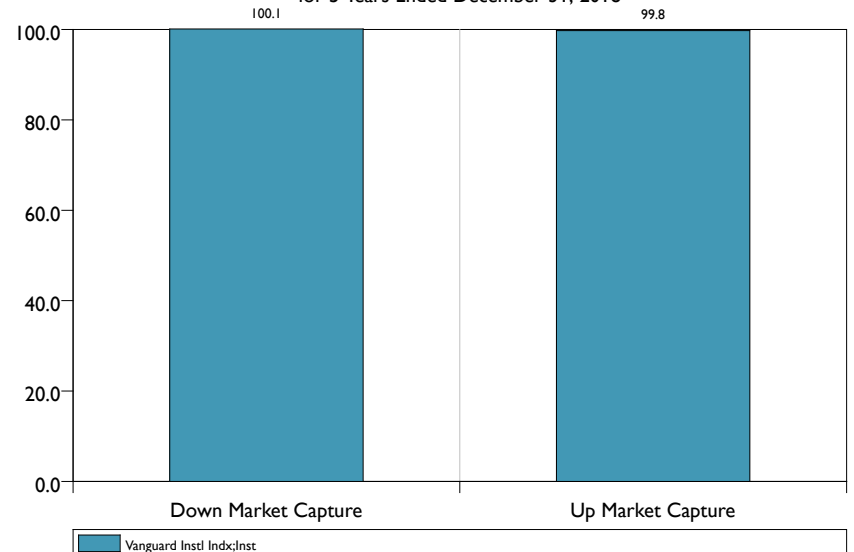

**VANGUARD FTSE SOCIAL INDEX
STYLE: LARGE CAP CORE EQUITY
YEAR ENDED DECEMBER 31, 2018**

Organization		Vanguard Funds
Product Name	FTSE Social Index	
Fund Inception	May 31, 2000	
Ownership Structure	Client-owned Mutual Fund Company	
Firm Information	Located in Valley Forge, Pennsylvania; Founded in 1975 with over \$5.1 trillion in assets under management.	
Investment Strategy	Fund seeks to mirror holdings and portfolio characteristics of the FTSE4Good US Select Index.	
Key Professionals	Gerard O'Reilly and William Coleman	
Index	FTSE 4 Good U.S. Select	
Assets In Product	\$4.8 billion	
Fees	12 bps	
Vehicle Type	Mutual Fund (VFTNX)	

Domestic Equity Style Map
for 5 Years Ended December 31, 2018

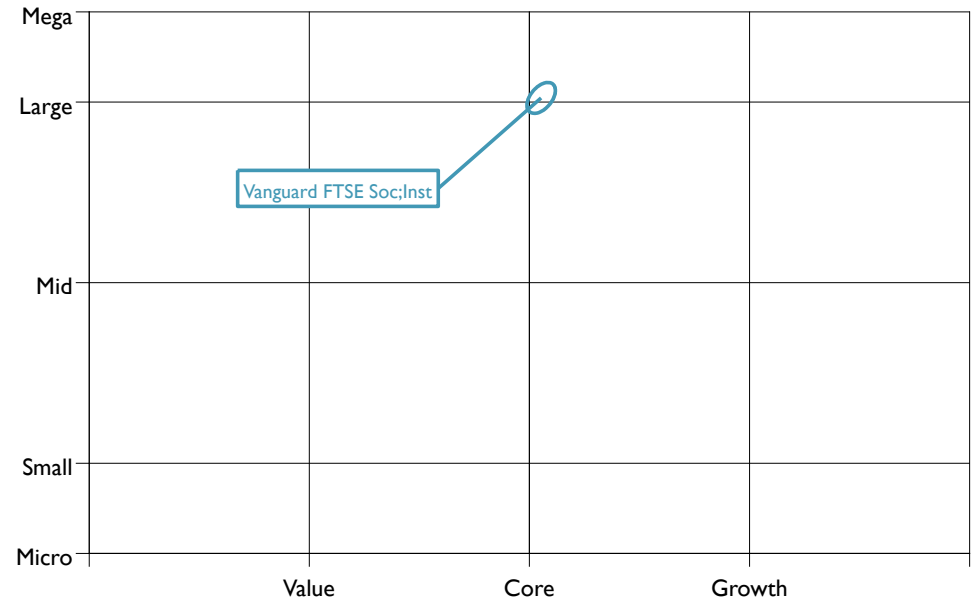

**Rolling 12 Quarter Scatter Chart for 5 Years
Ended December 31, 2018**

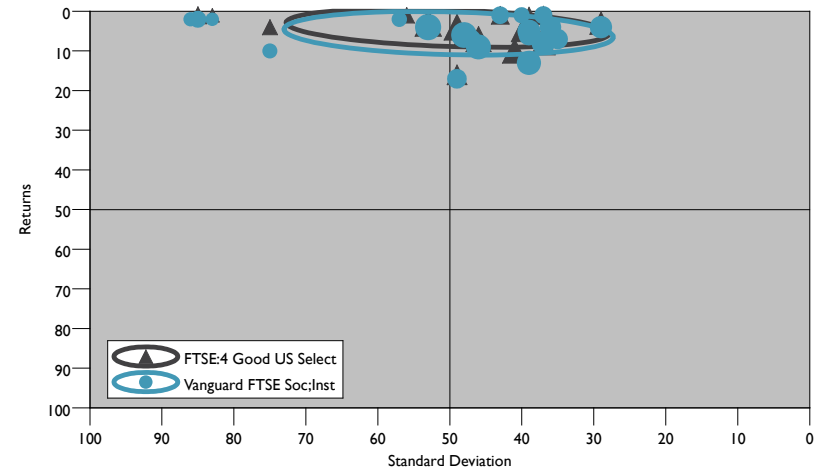

	December 31, 2018 Market Value	% of Plan Assets
Vanguard FTSE Social Index	\$16,576,362	1.4%



VANGUARD FTSE SOCIAL INDEX STYLE: LARGE CAP CORE EQUITY YEAR ENDED DECEMBER 31, 2018

Returns for Calendar Years
10 Years Ended December 31, 2018
Group: Callan Large Cap Core Mutual Funds

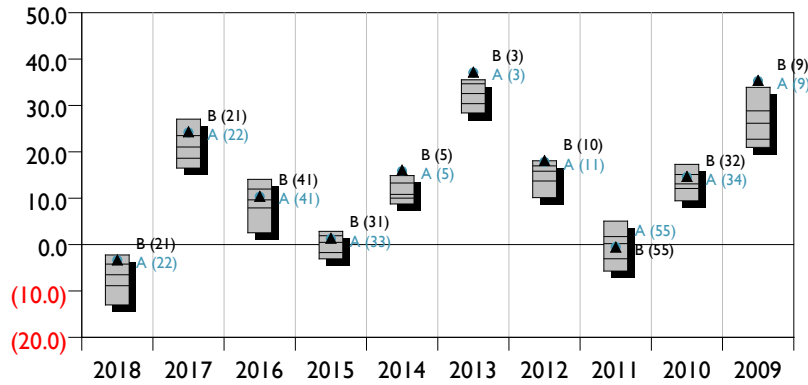

Returns for 12 Quarter Rolling Periods
5 Years Ended December 31, 2018
Group: Callan Large Cap Core Mutual Funds

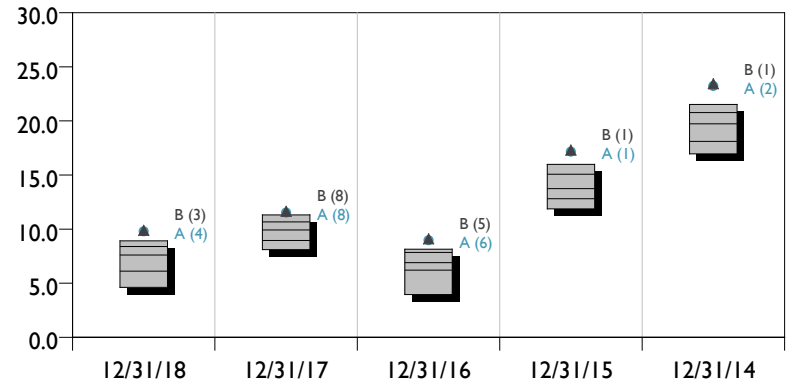

10th Percentile	(2.22)	27.05	14.07	2.86	14.88	35.54	18.08	5.09	17.32	33.92
25th Percentile	(4.21)	23.49	11.98	1.91	13.28	34.68	16.98	1.74	15.12	28.83
Median	(6.52)	21.05	9.66	0.49	10.83	32.57	15.81	0.21	13.07	26.18
75th Percentile	(8.88)	18.60	7.91	(1.74)	10.01	30.39	13.70	(3.06)	12.11	22.73
90th Percentile	(13.00)	16.49	2.55	(3.07)	8.77	28.41	10.13	(5.70)	9.45	20.97

10th Percentile	8.92	11.32	8.15	15.99	21.53
25th Percentile	8.39	10.66	7.84	15.08	20.76
Median	7.60	9.92	6.90	13.75	19.74
75th Percentile	6.12	8.94	6.21	12.82	18.10
90th Percentile	4.62	8.11	3.96	11.88	16.96

Vanguard FTSE Soc:Inst ● A (3.38) 24.19 10.34 1.27 15.85 37.09 17.84 (0.52) 14.58 35.27
 FTSE:4 Good US Select ▲ B (3.32) 24.33 10.42 1.38 16.06 37.20 18.14 (0.53) 14.69 35.41

Vanguard FTSE Soc:Inst ● A 9.80 11.54 8.98 17.16 23.24
 FTSE:4 Good US Select ▲ B 9.90 11.65 9.12 17.31 23.45

Statistics
for 5 Years Ended December 31, 2018
Group: Callan Large Cap Core Mutual Funds

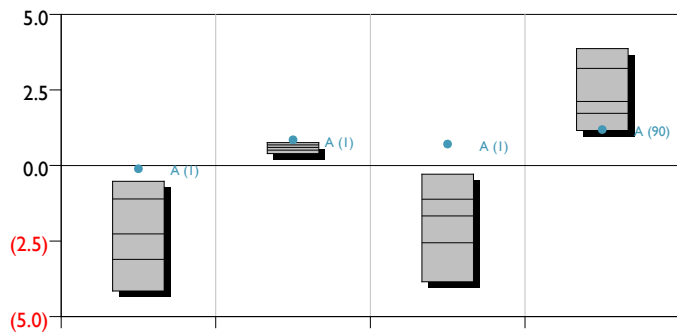

10th Percentile	(0.52)	0.76	(0.29)	3.87
25th Percentile	(1.11)	0.68	(1.11)	3.21
Median	(2.26)	0.60	(1.67)	2.12
75th Percentile	(3.11)	0.51	(2.56)	1.73
90th Percentile	(4.15)	0.40	(3.85)	1.16

Vanguard FTSE Soc:Inst ● A (0.11) 0.85 0.71 1.19

Statistics
for 5 Years Ended December 31, 2018

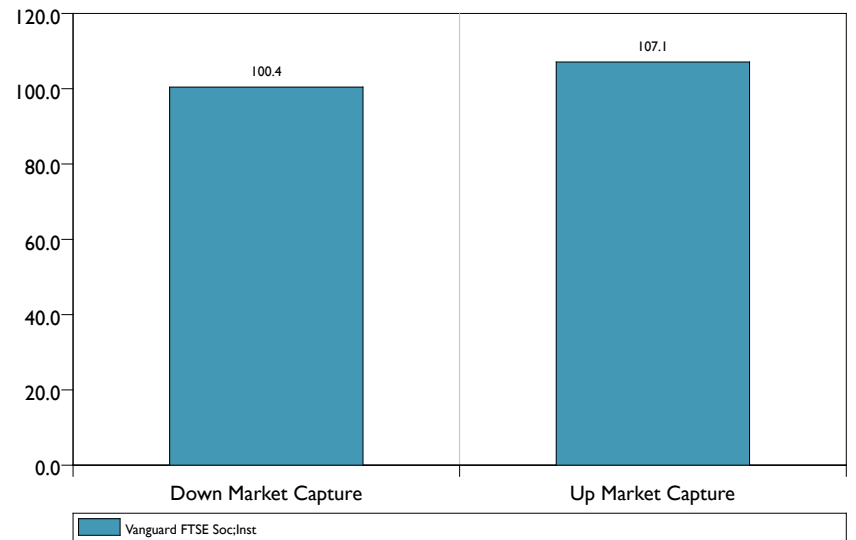

BOSTON COMPANY DYNAMIC LARGE CAP VALUE STYLE: LARGE CAP VALUE YEAR ENDED DECEMBER 31, 2018

Organization		The Boston Company Asset Management LLC
Product Name	Dynamic Large Cap Value	
Product Inception Date	Strategy: 1/1/1994; Vehicle: 2013	
Ownership Structure	The Boston Company Asset Management is a subsidiary of Bank of New York Mellon Corporation. (NYSE: BK)	
Firm Information	The Boston Company Asset Management was founded in 1970 and was combined with Mellon Capital and Standish Mellon to form Mellon Investments. Mellon Investments has \$498b in assets under management.	
Investment Philosophy	The Dynamic Large Cap Value Team believes that a disciplined value-oriented, research-driven, and risk-controlled portfolio will yield strong results over a full market cycle. The team measures each security's relative valuation to the market, sector, and historical valuations. Further, the team believes that there is no "one-size fits all" approach to fundamental analysis and rely on their deep sector knowledge	
# of holdings	65-100	
% in Top Ten	33%	
Turnover	93%	
Index	Russell 1000 Value	
Benchmark Awareness	Benchmark aware with a +/-10% sector weighting to the Russell 1000 Value Index. Maximum investment in one stock is generally limited to 5%.	
Weighted Avg market cap	\$129 billion	
Price/Earnings	12.8	
Key Professionals	Brian Ferguson (Senior PM); John Bailer, CFA (Senior Research Analyst); David Intoppa (Senior Research Analyst)	
Assets In Product	\$5.1 billion	
Fees	42 bps	
Vehicle Type	Collective Investment Trust	

	December 31, 2018	% of Plan
	Market Value	Assets
EB Dynamic Value	\$67,908,280	5.6%

Domestic Equity Style Map for 5 Years Ended December 31, 2018

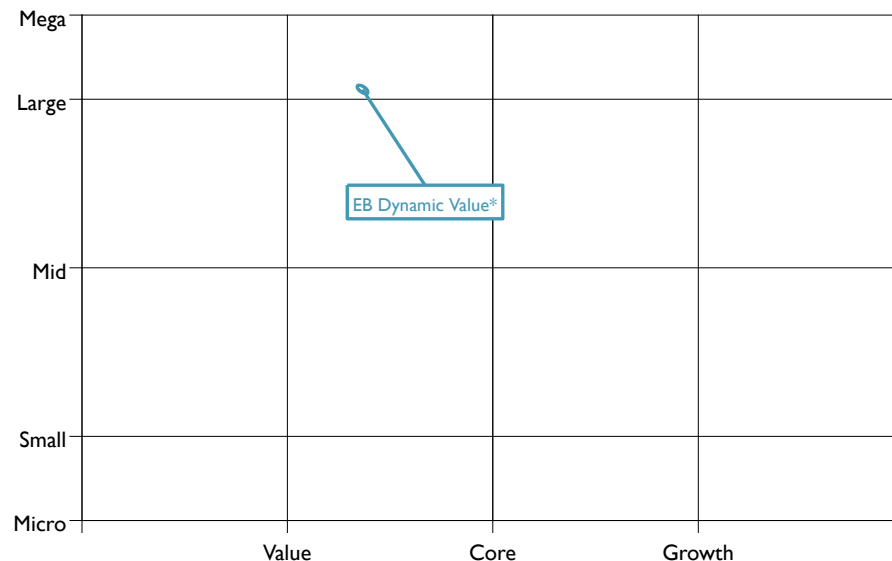

Rolling 12 Quarter Scatter Chart for 5 Years Ended December 31, 2018

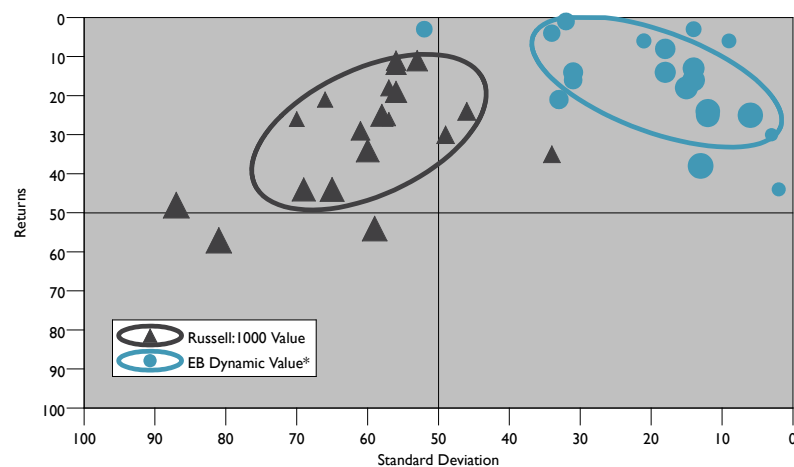

BLACKROCK LARGE CAP VALUE STYLE: LARGE CAP VALUE YEAR ENDED DECEMBER 31, 2018

Returns for Calendar Years
10 Years Ended December 31, 2018
Group: Callan Large Cap Value Mutual Funds

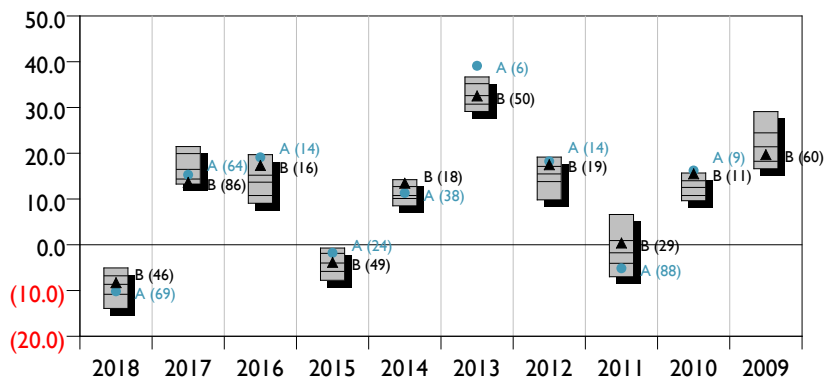

10th Percentile	(5.06)	21.46	19.70	(0.69)	14.23	36.71	19.18	6.64	15.71	29.12
25th Percentile	(6.77)	19.92	15.20	(1.86)	12.71	35.20	17.12	0.93	13.98	24.46
Median	(8.65)	16.47	13.69	(4.00)	10.76	32.59	15.48	(1.76)	12.53	21.42
75th Percentile	(10.84)	14.36	10.76	(5.83)	10.11	30.72	13.81	(4.04)	10.77	18.25
90th Percentile	(13.89)	13.27	9.10	(7.74)	8.52	29.14	9.84	(6.99)	9.66	16.63

EB Dynamic Value*	● A	(10.18)	15.29	19.11	(1.76)	11.31	39.11	18.24	(5.14)	16.22	--
Russell:1000 Value	▲ B	(8.27)	13.66	17.34	(3.83)	13.45	32.53	17.51	0.39	15.51	19.69

Returns for 12 Quarter Rolling Periods
5 Years Ended December 31, 2018
Group: Callan Large Cap Value Mutual Funds

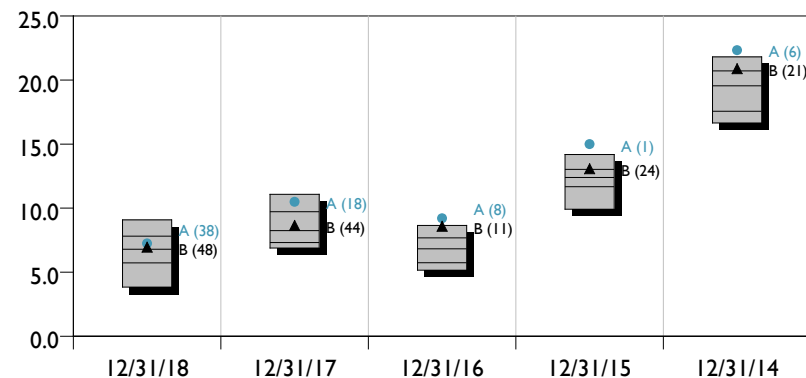

10th Percentile	9.08	11.08	8.66	14.19	21.82
25th Percentile	7.81	9.72	7.69	13.03	20.72
Median	6.80	8.24	6.83	12.40	19.54
75th Percentile	5.73	7.31	5.74	11.68	17.56
90th Percentile	3.84	6.89	5.17	9.92	16.66

EB Dynamic Value*	● A	7.25	10.50	9.21	15.00	22.33
Russell:1000 Value	▲ B	6.95	8.65	8.59	13.08	20.89

Statistics relative to Russell:1000 Value
for 5 Years Ended December 31, 2018
Group: Callan Large Cap Value Mutual Funds

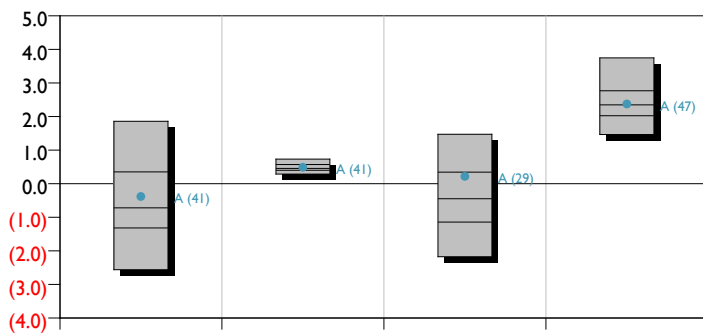

10th Percentile	1.86	0.73	1.47	3.75
25th Percentile	0.35	0.57	0.34	2.77
Median	(0.72)	0.46	(0.45)	2.35
75th Percentile	(1.32)	0.40	(1.14)	2.02
90th Percentile	(2.56)	0.29	(2.17)	1.47

EB Dynamic Value*	● A	(0.38)	0.49	0.22	2.37
-------------------	-----	--------	------	------	------

Statistics relative to Russell:1000 Value
for 5 Years Ended December 31, 2018

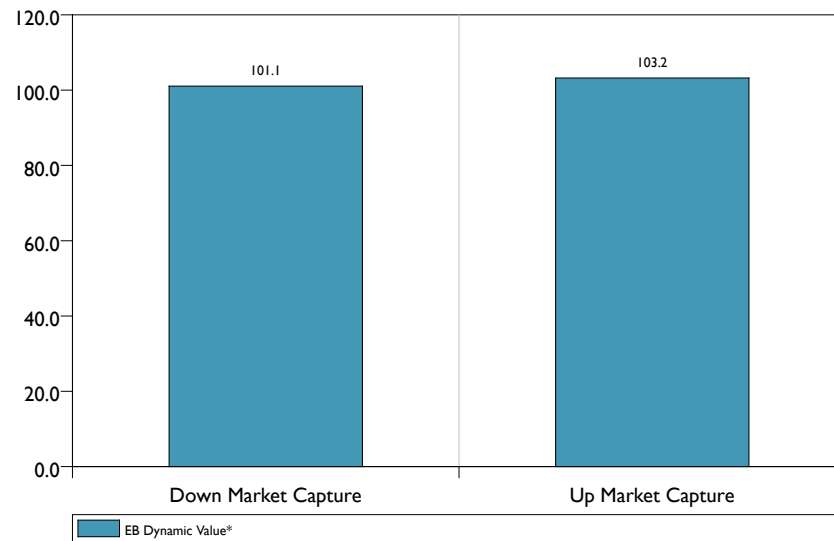

T ROWE PRICE BLUE CHIP GROWTH STYLE: LARGE CAP GROWTH YEAR ENDED DECEMBER 31, 2018

Domestic Equity Style Map
for 5 Years Ended December 31, 2018

Organization		T. Rowe Price
Product Name	US Large-Cap Core Growth Equity Strategy	
Product Inception Date	Strategy: 6/30/1993	
Ownership Structure	T. Rowe Price Associates, Inc. is a wholly-owned Subsidiary of T. Rowe Price Group, Inc. (NYSE: TROW)	
Firm Information	T. Rowe Price was founded in 1937 and is headquartered in Baltimore, Maryland. The company has been managing institutional portfolios since 1951 and currently has greater than \$962b in assets under management.	
Investment Philosophy	The team believes that investing in high-quality, large-cap companies with sustainable competitive advantages can produce attractive returns with moderate risk. They seek to identify companies with attractive business models, operational and financial flexibility, and seasoned managements teams. They believe that these companies are best identified through bottom-up, fundamental research.	
# of holdings	100-140	
% in Top Ten	45%	
Turnover	30-40%	
Index	Russell 1000 Growth	
Benchmark Awareness	Typical position size range from 0.25% to 5%. Individual positions are typically +/- 4% Russell 1000 Growth. Sector weights typically 0.5x to 3x Russell 1000 Growth.	
Weighted Avg market cap	\$104.8 billion	
Price/Earnings	21.6	
Key Professionals	Larry J. Puglia, CFA	
Assets In Product	\$86.3 billion	
Fees	45 bps	
Vehicle Type	Collective Investment Trust	

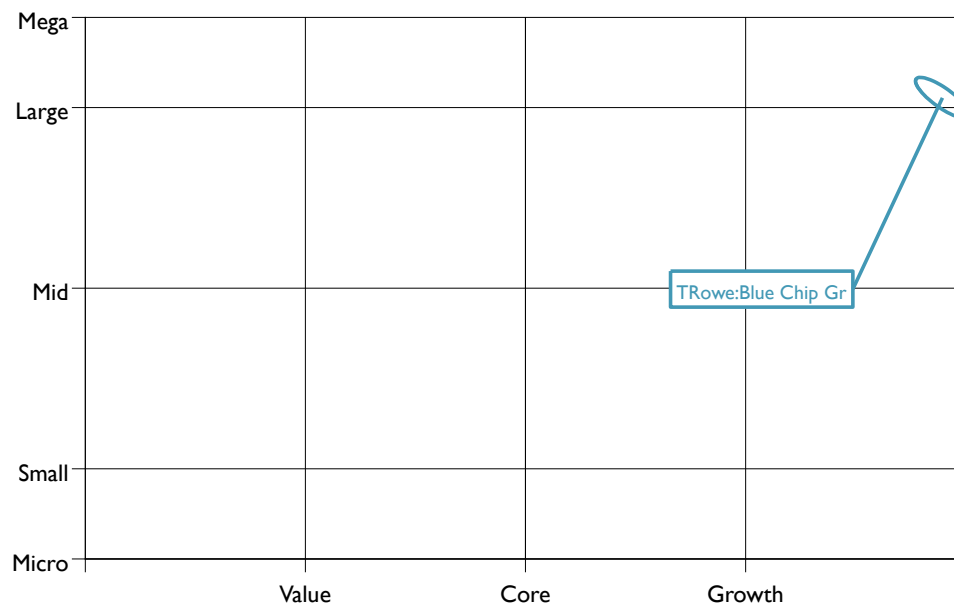

**Rolling 12 Quarter Scatter Chart for 5 Years
Ended December 31, 2018**

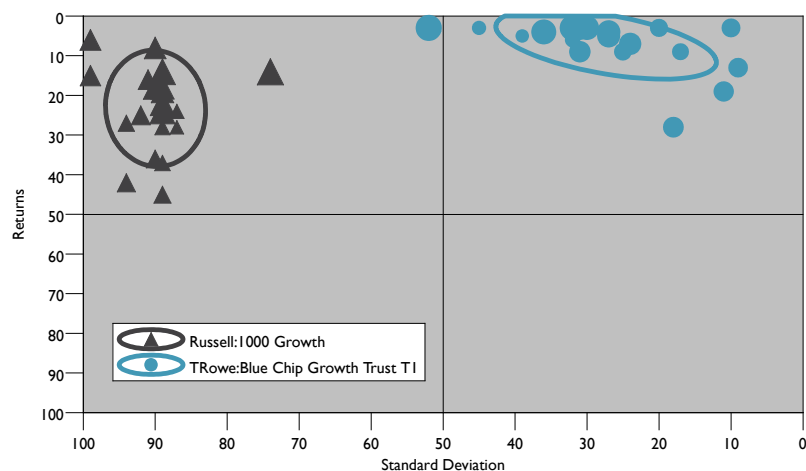

	December 31, 2018 Market Value	% of Plan Assets
T. Rowe Price Blue Chip Growth	\$86,005,045	7.1%



T ROWE PRICE BLUE CHIP GROWTH STYLE: LARGE CAP GROWTH YEAR ENDED DECEMBER 31, 2018

Returns for Calendar Years
10 Years Ended December 31, 2018
Group: Callan Large Cap Growth Mutual Funds

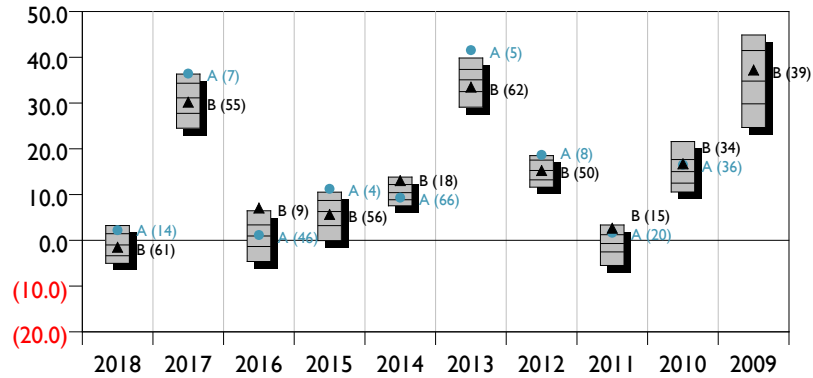

Returns for 12 Quarter Rolling Periods
5 Years Ended December 31, 2018
Group: Callan Large Cap Growth Mutual Funds

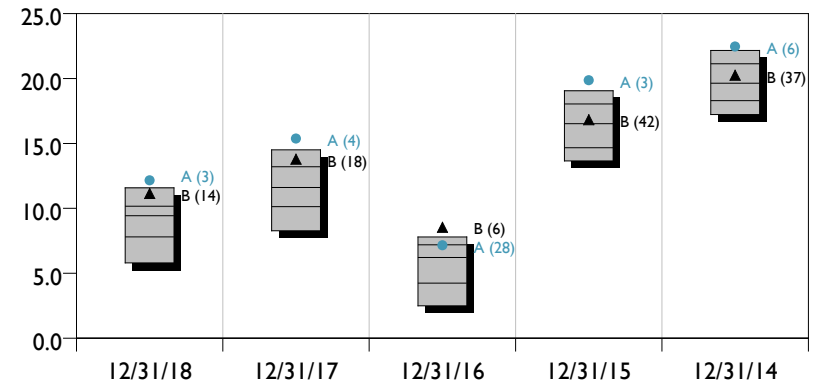

10th Percentile	3.24	36.36	6.46	10.56	13.84	39.86	18.54	3.36	21.60	44.91
25th Percentile	1.43	34.32	3.38	8.72	12.18	37.33	17.54	1.23	17.66	41.47
Median	(1.02)	31.14	0.93	6.28	10.43	35.08	15.25	(0.69)	15.01	34.80
75th Percentile	(3.37)	27.75	(1.36)	3.20	8.85	32.49	13.21	(2.53)	12.51	29.83
90th Percentile	(5.01)	24.52	(4.61)	(0.05)	7.56	29.13	11.63	(5.49)	10.57	24.68

10th Percentile	11.59	14.51	7.80	19.06	22.17
25th Percentile	10.16	13.21	7.19	18.04	21.13
Median	9.43	11.61	6.22	16.52	19.64
75th Percentile	7.80	10.14	4.24	14.66	18.30
90th Percentile	5.81	8.28	2.50	13.66	17.23

TRowe:Blue Chip Gr	● A	2.23	36.46	1.15	11.27	9.34	41.57	18.67	1.67	16.54	--
Russell:1000 Growth	▲ B	(1.51)	30.21	7.08	5.67	13.05	33.48	15.26	2.64	16.71	37.21

TRowe:Blue Chip Gr	● A	12.16	15.38	7.16	19.87	22.47
Russell:1000 Growth	▲ B	11.15	13.79	8.55	16.83	20.26

Statistics relative to Russell:1000 Growth
for 5 Years Ended December 31, 2018
Group: Callan Large Cap Growth Mutual Funds

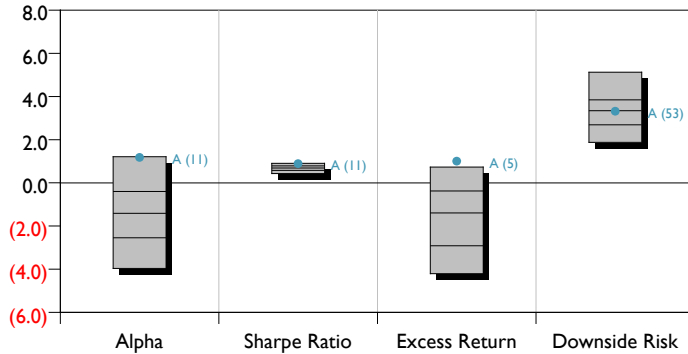

10th Percentile	1.22	0.91	0.73	5.13
25th Percentile	(0.40)	0.79	(0.38)	3.85
Median	(1.41)	0.69	(1.39)	3.34
75th Percentile	(2.54)	0.58	(2.91)	2.69
90th Percentile	(3.96)	0.44	(4.21)	1.88

TRowe:Blue Chip Gr	● A	1.18	0.89	1.01	3.32
--------------------	-----	------	------	------	------

Statistics relative to Russell:1000 Growth
for 5 Years Ended December 31, 2018

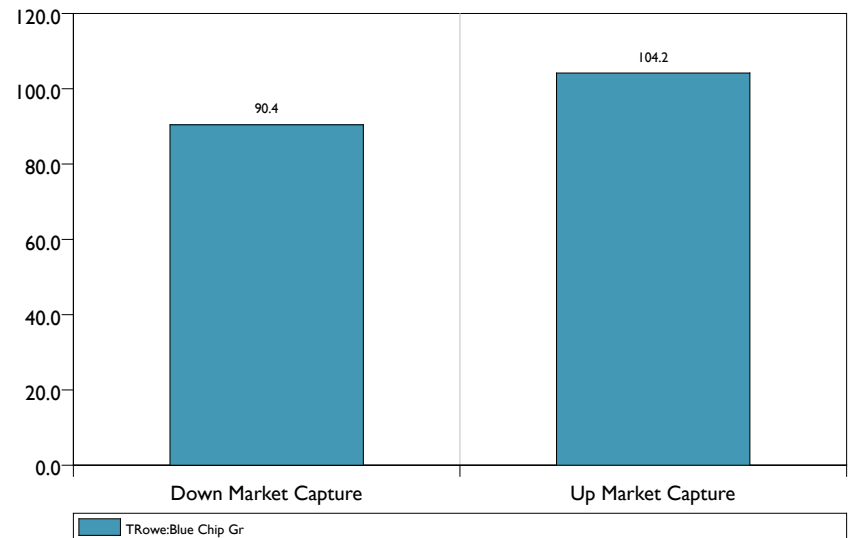

**MFS MID CAP VALUE
STYLE: MID CAP VALUE
YEAR ENDED DECEMBER 31, 2018**

Organization		MFS
Product Name	MFS Mid Cap Value	
Product Inception Date	8/31/2001 (Current Team & Process: November 2008)	
Ownership Structure	MFS is a majority-owned subsidiary of Sun Life of Canada (U.S.) Financial Services Holdings, Inc. which is an indirect majority-owned subsidiary of Sun Life Financial, Inc. (NYSE: SLF).	
Firm Information	MFS was founded in 1924 and is headquartered in Boston, MA. \$428.4 billion in assets under management.	
Investment Philosophy	MFS seeks mid-cap companies with attractive valuations and high quality fundamentals or significant potential for improvement.	
# of holdings	142	
% in Top Ten	12%	
Turnover	27%	
Index	Russell Mid Cap Value	
Benchmark Awareness	Sector allocation is generally limited to the greater of 5% to 1.5x the Index. Each industry is capped at 25%. The Fund strives to be fully invested with minimal allocation to cash. The Fund has the ability to invest up to 10% in foreign stocks.	
Weighted Avg market cap	10.1 billion	
Price/Earnings	14.7	
Key Professionals	Brooks Taylor and Kevin Schmitz	
Assets In Product	\$8.3 billion	
Fees	71 bps	
Vehicle Type	Mutual Fund (MVCKX)	

Domestic Equity Style Map
for 5 Years Ended December 31, 2018

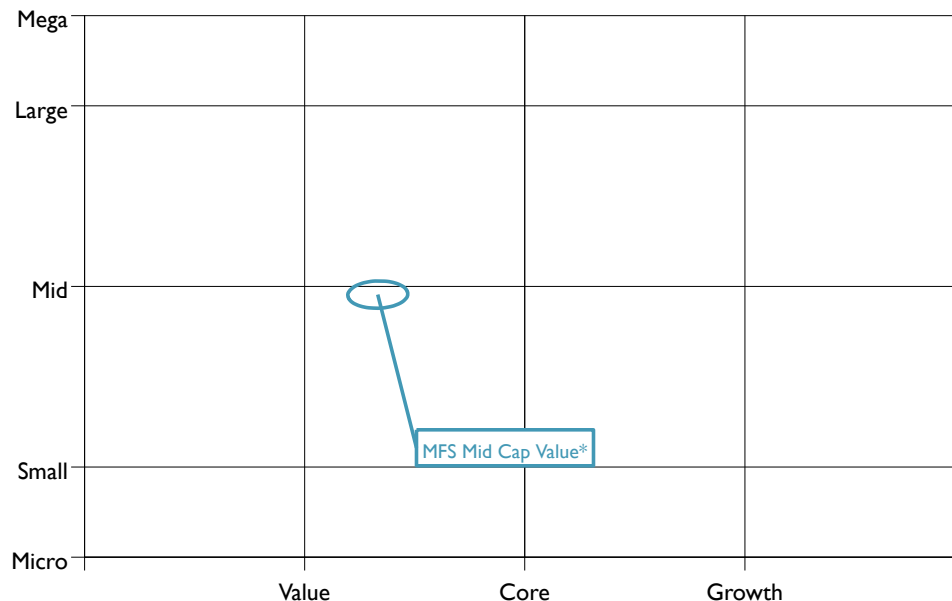

**Rolling 12 Quarter Scatter Chart for 5 Years
Ended December 31, 2018**

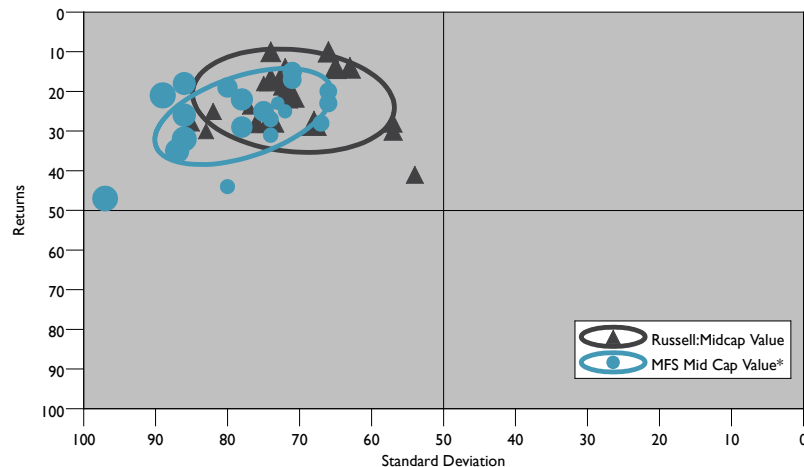

	December 31, 2018	% of Plan
	Market Value	Assets
MFS Mid Cap Value	\$34,627,054	2.9%



MFS MID CAP VALUE STYLE: MID CAP VALUE YEAR ENDED DECEMBER 31, 2018

Returns for Calendar Years
10 Years Ended December 31, 2018
Group: Callan Mid Cap Value Mutual Funds

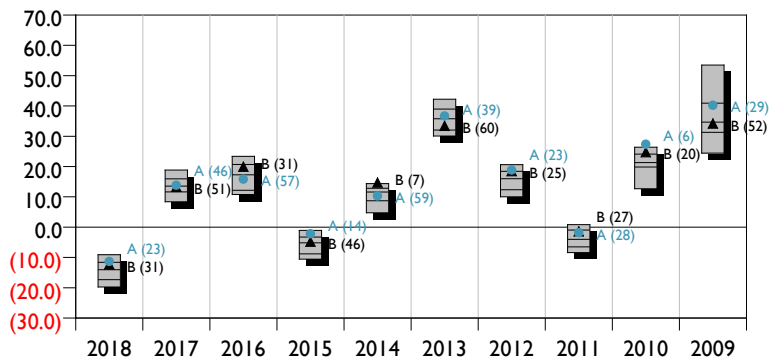

Returns for 12 Quarter Rolling Periods
5 Years Ended December 31, 2018
Group: Callan Mid Cap Value Mutual Funds

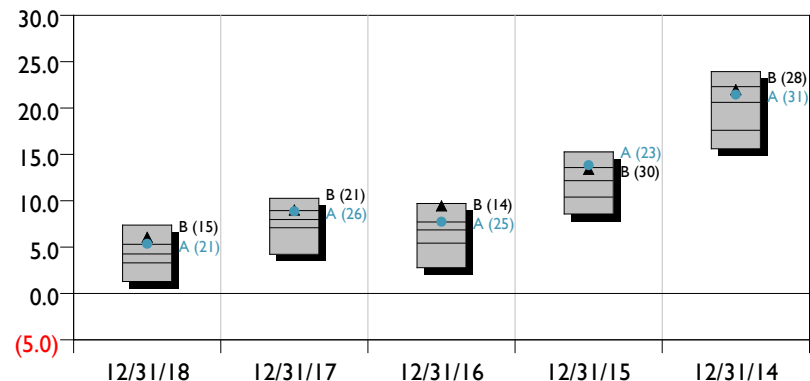

10th Percentile	(9.09)	18.88	23.38	(1.04)	14.40	42.23	0.86	26.42	53.52	
25th Percentile	(11.61)	15.95	20.69	(3.29)	12.83	38.96	18.42	(0.96)	24.12	40.91
Median	(14.05)	13.54	17.27	(5.18)	11.60	35.77	15.98	(4.03)	21.30	34.67
75th Percentile	(17.31)	11.62	12.19	(8.79)	8.69	32.06	12.34	(6.49)	19.85	31.31
90th Percentile	(19.73)	8.42	10.81	(10.55)	4.76	30.09	10.04	(8.36)	12.69	24.45
MFS Mid Cap Value* ● A	(11.31)	13.84	15.86	(2.14)	10.29	36.69	18.86	(1.81)	27.36	40.24
Russell:Midcap Value ▲ B	(12.29)	13.34	20.00	(4.78)	14.75	33.46	18.51	(1.38)	24.75	34.21

10th Percentile	7.39	10.27	9.71	15.26	23.94
25th Percentile	5.30	8.94	7.72	13.59	22.31
Median	4.26	7.97	6.85	12.17	20.62
75th Percentile	3.30	7.09	5.43	10.40	17.60
90th Percentile	1.29	4.23	2.79	8.58	15.61
MFS Mid Cap Value* ● A	5.37	8.88	7.73	13.84	21.46
Russell:Midcap Value ▲ B	6.06	9.00	9.45	13.40	21.98

Statistics relative to Russell:Midcap Value
for 5 Years Ended December 31, 2018
Group: Callan Mid Cap Value Mutual Funds

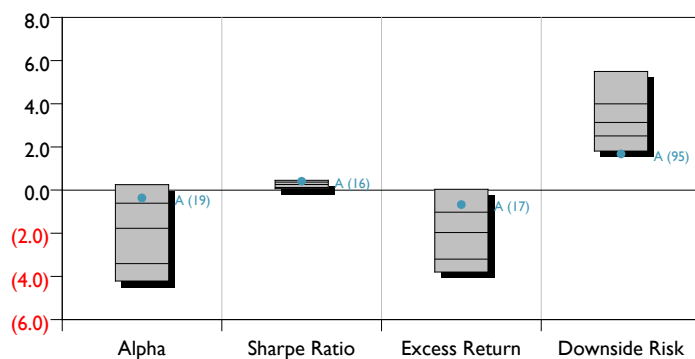

10th Percentile	0.26	0.46	0.04	5.50
25th Percentile	(0.61)	0.37	(1.03)	3.99
Median	(1.77)	0.26	(1.96)	3.13
75th Percentile	(3.41)	0.12	(3.20)	2.51
90th Percentile	(4.21)	0.07	(3.79)	1.81

MFS Mid Cap Value* ● A	(0.36)	0.41	(0.67)	1.68
------------------------	--------	------	--------	------

Statistics relative to Russell:Midcap Value
for 5 Years Ended December 31, 2018

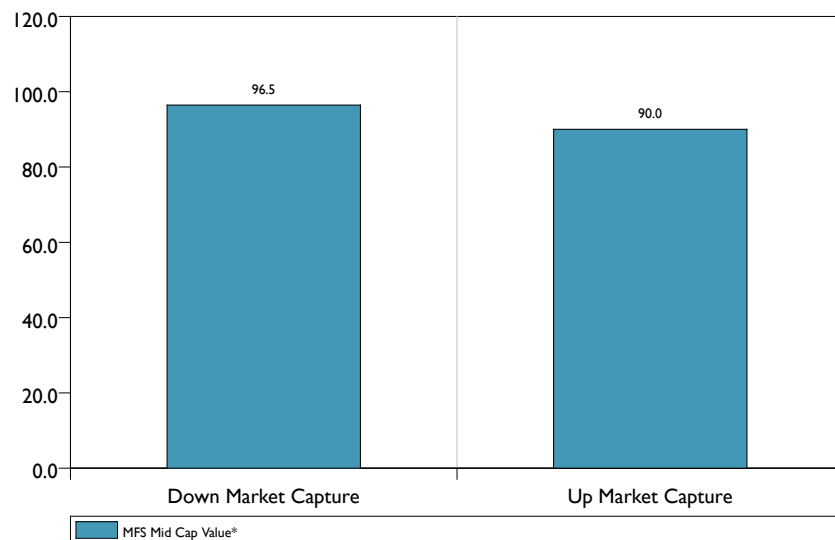

VANGUARD CAPITAL OPPORTUNITY STYLE: MID CAP GROWTH YEAR ENDED DECEMBER 31, 2018

Organization		Vanguard
Product Name	Capital Opportunity	
Product Inception Date	August 14, 1995	
Ownership Structure	Client-owned Mutual Fund Company	
Firm Information	Located in Valley Forge, Pennsylvania; Founded in 1975 with over \$5.1 trillion in assets under management.	
Investment Philosophy	Portfolio managers follow a contrarian-growth approach, looking for swiftly growing firms trading at lower valuations. Fundamental analysis and a long-term investment horizon are key components of the advisor's investment strategy.	
# of holdings	158	
% in Top Ten	32%	
Turnover	10%	
Index	Russell Mid Cap Growth	
Benchmark Awareness	There are no portfolio requirements with respect to variance from the benchmark at the industry or sector level.	
Weighted Avg market cap	\$112.1 billion	
Price/Earnings	9.5	
Key Professionals	PRIMECAP Management Company: Kolokotronis, Fried, Mordecai, Ansari and Marchetti	
Assets In Product	\$15 billion	
Fees	37 bps	
Vehicle Type	Mutual Fund (VHCAX)	

Domestic Equity Style Map
for 5 Years Ended December 31, 2018

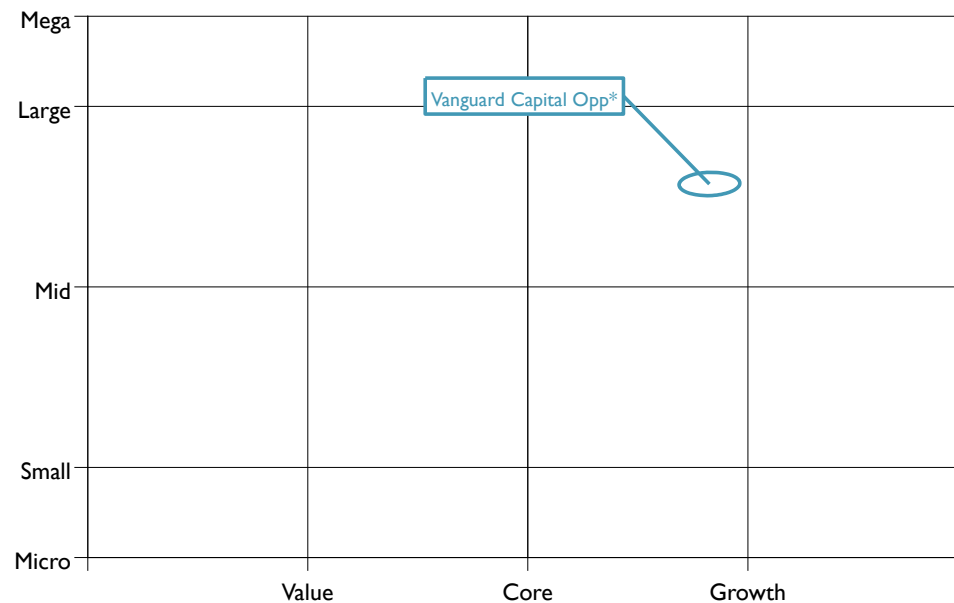

Rolling 12 Quarter Scatter Chart for 5 Years
Ended December 31, 2018

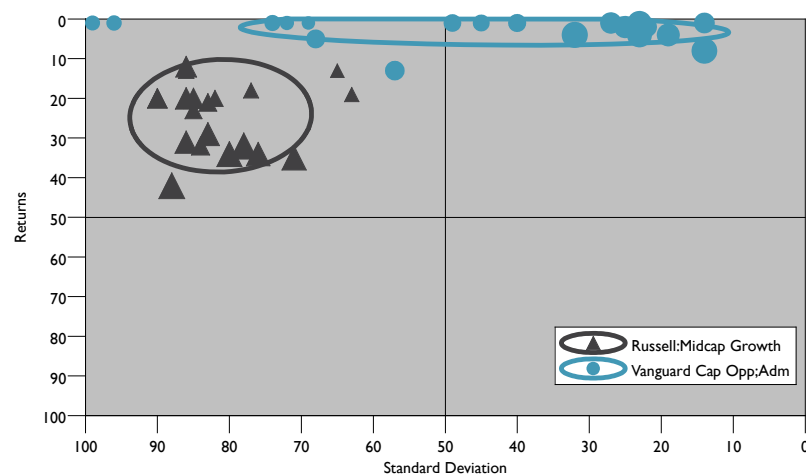

	December 31, 2018 Market Value	% of Plan Assets
Vanguard Capital Opportunity	\$107,980,232	9.0%



VANGUARD CAPITAL OPPORTUNITY STYLE: MID CAP GROWTH YEAR ENDED DECEMBER 31, 2018

Returns for Calendar Years
10 Years Ended December 31, 2018
Group: Callan Mid Cap Growth Mutual Funds

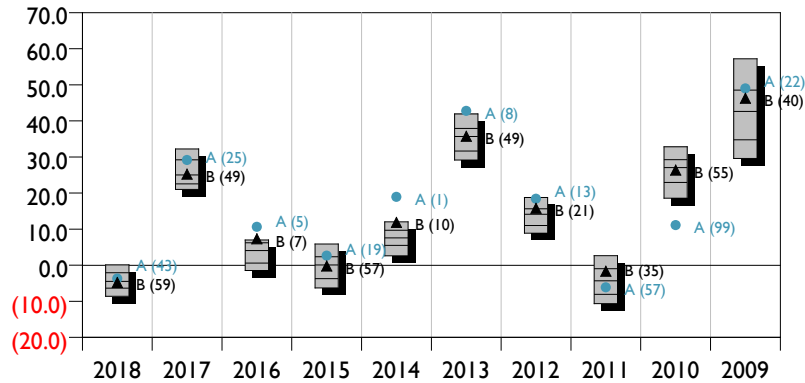

Returns for 12 Quarter Rolling Periods
5 Years Ended December 31, 2018
Group: Callan Mid Cap Growth Mutual Funds

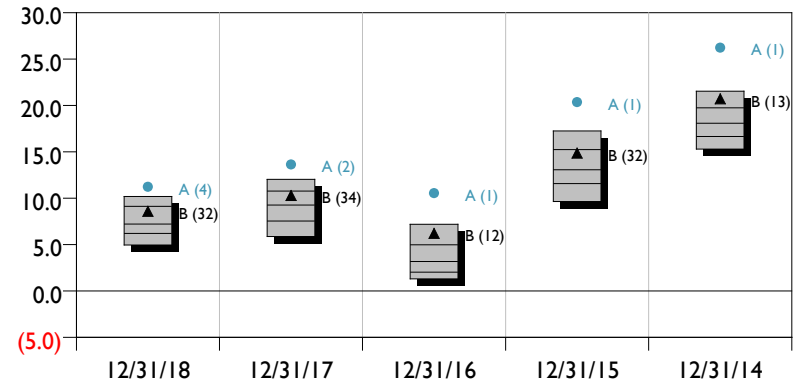

	2018	2017	2016	2015	2014	2013	2012	2011	2010	2009
10th Percentile	0.10	32.25	7.02	5.88	12.04	41.95	18.78	2.67	32.85	57.23
25th Percentile	(2.10)	29.20	6.19	2.36	9.68	37.93	15.62	(0.98)	29.24	48.52
Median	(4.47)	25.04	4.06	0.06	7.59	35.69	14.14	(4.34)	27.06	42.64
75th Percentile	(6.36)	22.53	0.59	(3.74)	5.49	31.66	10.99	(8.07)	22.94	34.76
90th Percentile	(8.60)	21.03	(1.45)	(6.28)	2.61	29.19	8.87	(10.64)	18.60	29.59
Vanguard Capital Opp* ● A	(3.69)	29.18	10.65	2.67	18.95	42.80	18.43	(6.11)	11.12	49.03
Russell:Midcap Growth ▲ B	(4.75)	25.27	7.33	(0.20)	11.90	35.74	15.81	(1.65)	26.38	46.29

	12/31/18	12/31/17	12/31/16	12/31/15	12/31/14
10th Percentile	10.20	12.04	7.20	17.27	21.54
25th Percentile	9.12	10.77	4.97	15.23	19.74
Median	7.21	9.27	3.17	13.07	18.09
75th Percentile	6.20	7.53	2.02	11.57	16.66
90th Percentile	4.97	5.88	1.31	9.65	15.30
Vanguard Capital Opp* ● A	11.24	13.64	10.55	20.37	26.24
Russell:Midcap Growth ▲ B	8.59	10.30	6.23	14.88	20.71

Statistics relative to Russell:Midcap Growth
for 5 Years Ended December 31, 2018
Group: Callan Mid Cap Growth Mutual Funds

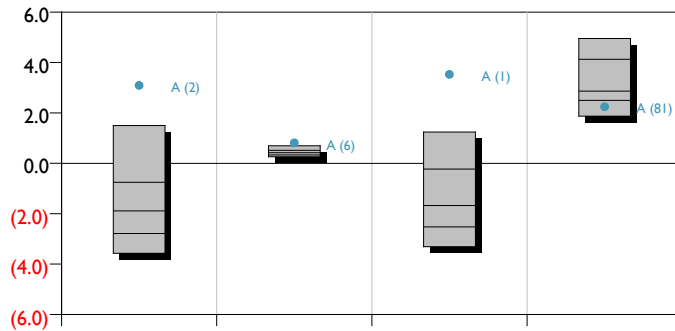

	Alpha	Sharpe Ratio	Excess Return	Downside Risk
10th Percentile	1.50	0.70	1.24	4.96
25th Percentile	(0.75)	0.51	(0.23)	4.13
Median	(1.89)	0.42	(1.67)	2.86
75th Percentile	(2.78)	0.33	(2.52)	2.50
90th Percentile	(3.57)	0.26	(3.31)	1.87
Vanguard Capital Opp* ● A	3.09	0.81	3.53	2.24

Statistics relative to Russell:Midcap Growth
for 5 Years Ended December 31, 2018

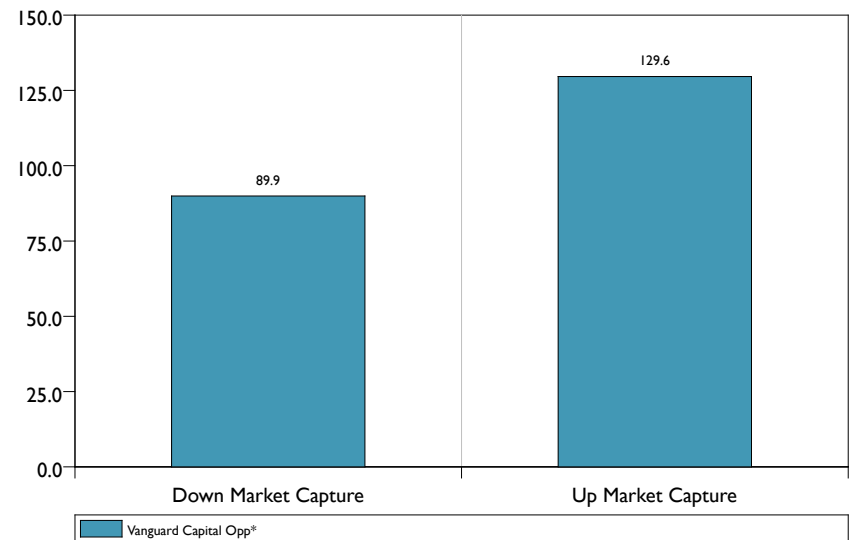

**VANGUARD EXTENDED MARKET INDEX
STYLE: SMALL CAP BROAD
YEAR ENDED DECEMBER 31, 2018**

Organization		Vanguard Funds
Product Name	Extended Market Index	
Fund Inception	December 21, 1987	
Ownership Structure	Client-owned Mutual Fund Company	
Firm Information	Located in Valley Forge, Pennsylvania; Founded in 1975 with over \$5.1 trillion in assets under management.	
Investment Strategy	Fund seeks to mirror holdings and portfolio characteristics of the S&P Completion Index.	
Key Professionals	Donald Butler and William Coleman	
Index	S&P Completion	
Assets In Product	\$66 billion	
Fees	6 bps	
Vehicle Type	Mutual Fund (VIEIX)	

Domestic Equity Style Map
for 5 Years Ended December 31, 2018

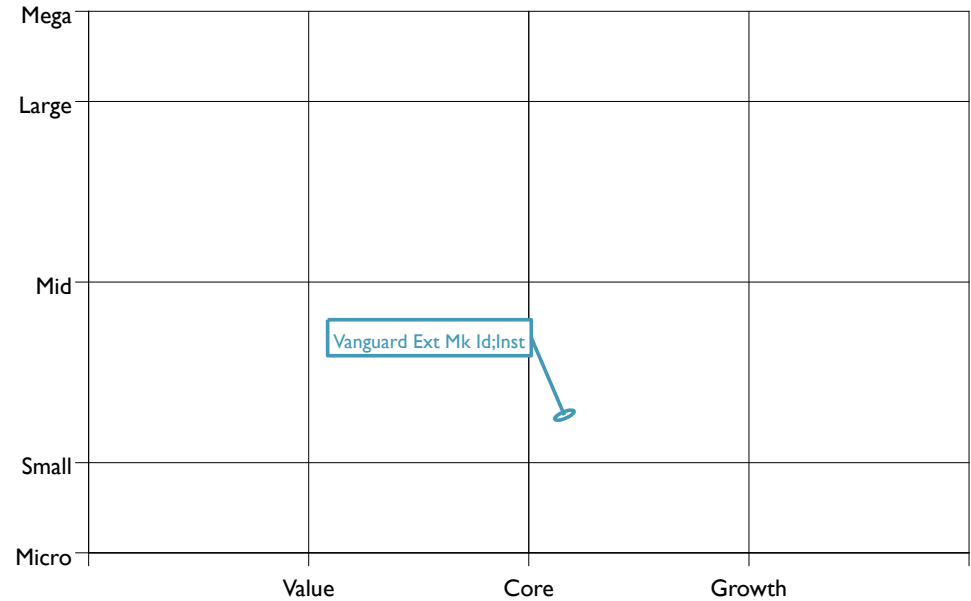

**Rolling 12 Quarter Scatter Chart for 5 Years
Ended December 31, 2018**

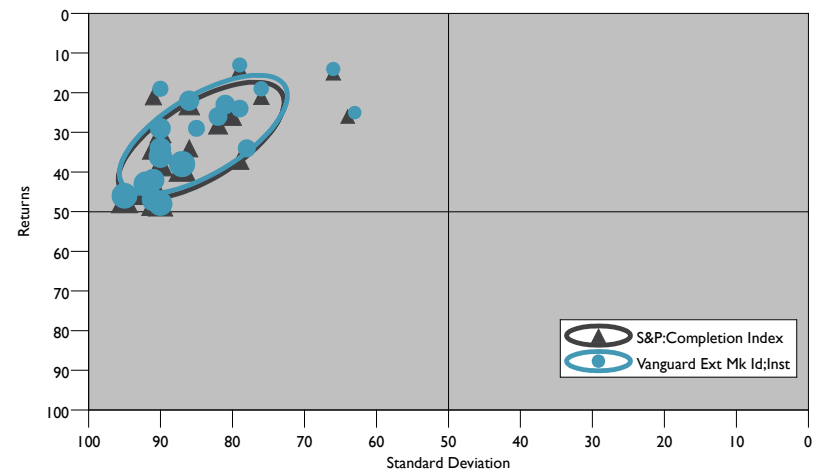

	December 31, 2018 Market Value	% of Plan Assets
Vanguard Extended Market Index	\$43,804,934	3.6%



VANGUARD EXTENDED MARKET INDEX STYLE: SMALL CAP BROAD YEAR ENDED DECEMBER 31, 2018

Returns for Calendar Years
10 Years Ended December 31, 2018
Group: Callan Small Cap Mutual Funds

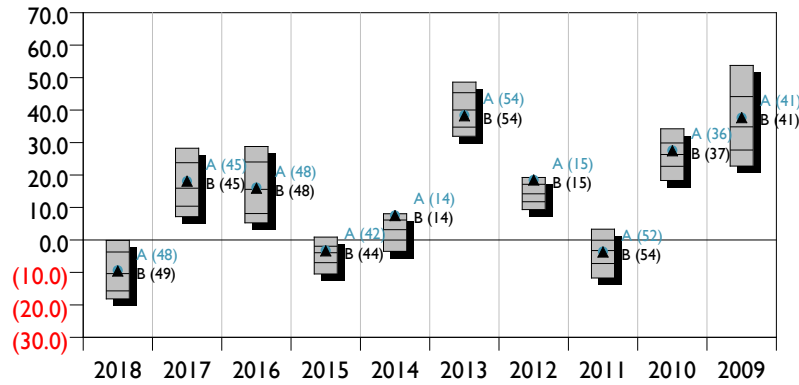

Returns for 12 Quarter Rolling Periods
5 Years Ended December 31, 2018
Group: Callan Small Cap Mutual Funds

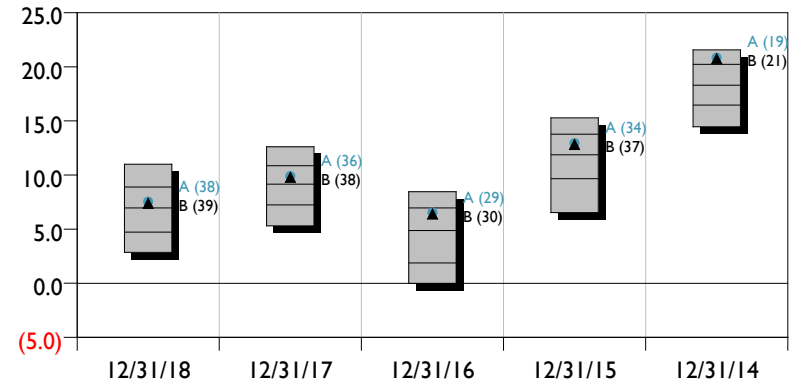

	2018	2017	2016	2015	2014	2013	2012	2011	2010	2009
10th Percentile	(0.13)	28.26	28.80	0.88	8.07	48.65	19.25	3.34	34.27	53.78
25th Percentile	(3.69)	23.77	24.00	(1.96)	6.14	45.35	17.13	(0.06)	29.86	44.14
Median	(10.39)	15.96	15.60	(3.94)	3.17	40.03	14.23	(3.25)	26.30	34.84
75th Percentile	(15.69)	10.38	8.12	(7.01)	(0.01)	34.74	11.77	(7.25)	22.67	27.71
90th Percentile	(18.13)	7.22	5.29	(10.44)	(3.50)	31.96	9.35	(11.71)	18.32	22.75

	12/31/18	12/31/17	12/31/16	12/31/15	12/31/14
10th Percentile	11.01	12.62	8.46	15.29	21.58
25th Percentile	8.89	10.86	6.96	13.78	20.22
Median	6.95	9.15	4.86	11.87	18.30
75th Percentile	4.72	7.24	1.87	9.65	16.46
90th Percentile	2.86	5.31	(0.01)	6.53	14.46

Vanguard Ext Mk Id;Inst	A	B
S&P:Completion Index	(9.35)	(9.57)

Vanguard Ext Mk Id;Inst	A	B
S&P:Completion Index	7.54	7.39

Statistics Relative to S&P:Completion Index
for 5 Years Ended December 31, 2018
Group: Callan Small Cap Mutual Funds

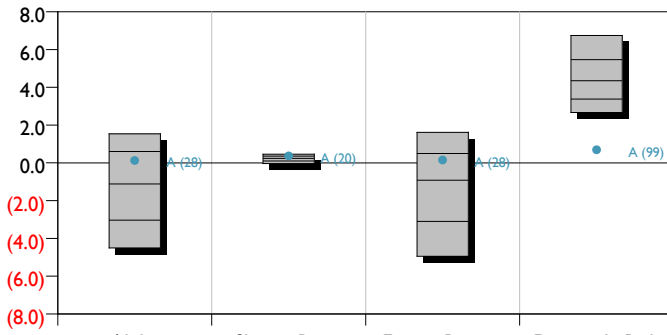

	Alpha	Sharpe Ratio	Excess Return	Downside Risk
10th Percentile	1.54	0.46	1.62	6.75
25th Percentile	0.60	0.36	0.49	5.46
Median	(1.12)	0.24	(0.92)	4.35
75th Percentile	(3.03)	0.10	(3.10)	3.38
90th Percentile	(4.50)	(0.03)	(4.94)	2.67

Vanguard Ext Mk Id;Inst	A
Alpha	0.13
Sharpe Ratio	0.37
Excess Return	0.15
Downside Risk	0.69

Statistics Relative to S&P:Completion Index
for 5 Years Ended December 31, 2018

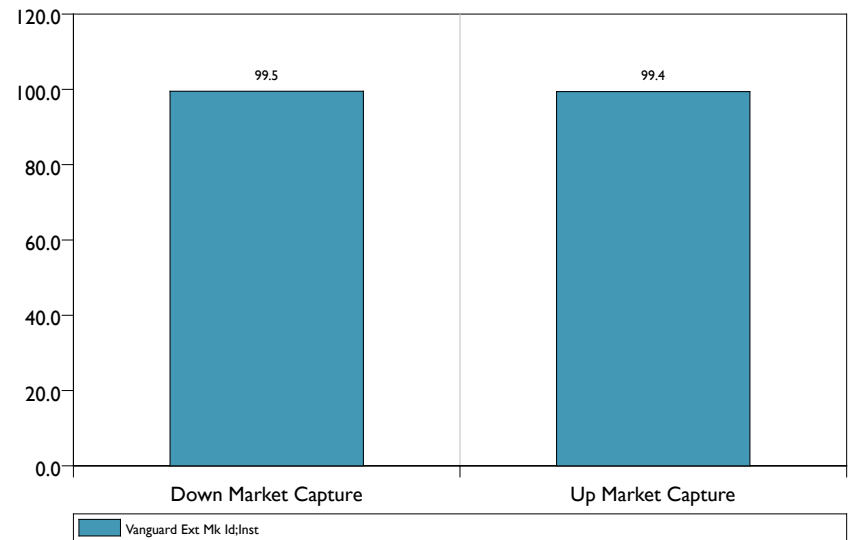

**FIDELITY LOW-PRICED STOCK
STYLE: SPECIALITY
YEAR ENDED DECEMBER 31, 2018**

Organization		Fidelity
Product Name	Low-Priced Stock	
Product Inception Date	December 27, 1989	
Ownership Structure	Fidelity Management & Research Company (FMR Co.), the investment advisor to Fidelity's family of mutual funds.	
Firm Information	Located in Boston, MA; Founded in 1946 with over \$2.4 trillion in assets under management.	
Investment Philosophy	The Fund strategy is to invest in low priced stocks of less than \$35 per share or have an earnings yield at or above the median for the Russell 2000 Index. These companies are generally small and mid-sized companies.	
# of holdings	836	
% in Top Ten	28%	
Turnover	11%	
Index	Russell 2000	
Benchmark Awareness	Not benchmark aware.	
Weighted Avg market cap	\$34.4 billion	
Price/Earnings	11.8	
Key Professionals	Joel Tillinghast, John Mirshekari, Shadman Riaz, Morgen Peck, Salim Hart and Sam Chamovitz	
Assets In Product	\$29 billion	
Fees	62 bps (25 bps revenue sharing). Net expense: 37 bps	
Vehicle Type	Mutual Fund (FLPSX)	

Domestic Equity Style Map
for 5 Years Ended December 31, 2018

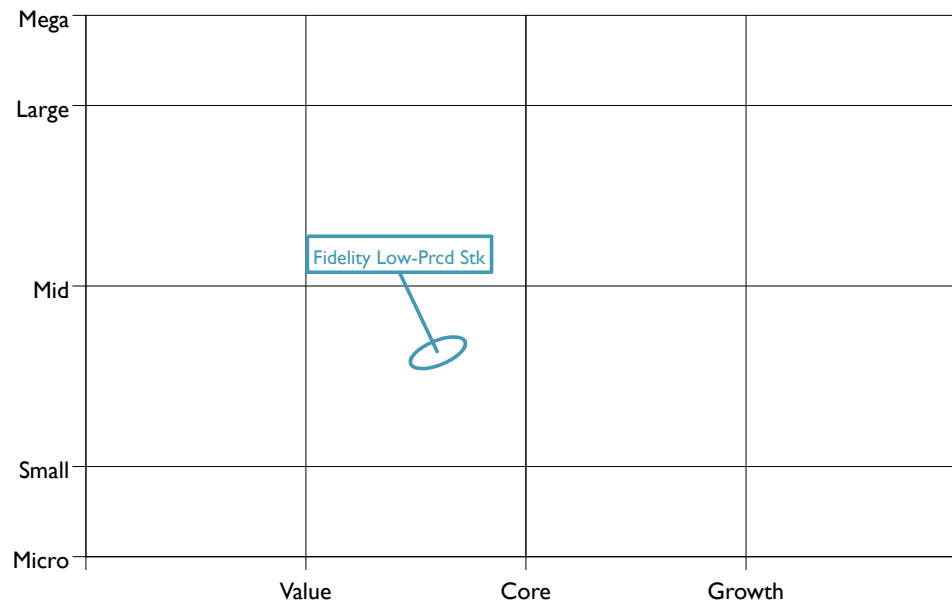

**Rolling 12 Quarter Scatter Chart for 5 Years
Ended December 31, 2018**

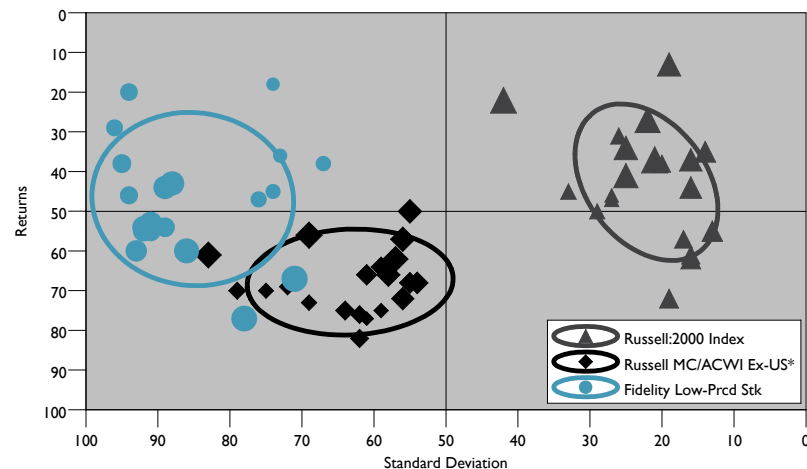

	December 31, 2018 Market Value	% of Plan Assets
Fidelity Low-Priced Stock	\$19,582,953	1.6%



FIDELITY LOW-PRICED STOCK STYLE: SPECIALITY YEAR ENDED DECEMBER 31, 2018

Returns for Calendar Years
10 Years Ended December 31, 2018
Group: Total Domestic Equity Mutual Funds

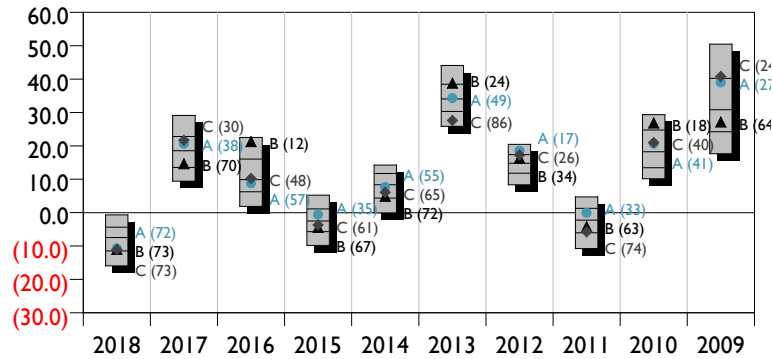

10th Percentile	(0.65)	29.14	22.56	5.26	14.29	44.09	20.49	4.74	29.36	50.51
25th Percentile	(4.34)	22.79	16.05	1.14	11.73	38.46	17.36	1.27	24.75	40.23
Median	(7.48)	18.53	9.85	(2.49)	8.36	34.07	14.79	(2.26)	18.22	30.82
75th Percentile	(11.49)	13.51	6.25	(5.71)	4.36	30.32	11.82	(6.03)	13.45	24.22
90th Percentile	(15.94)	9.44	1.91	(9.80)	(0.04)	25.87	8.38	(10.74)	10.16	17.69

Fidelity Low-Prd Stk	● A	(10.75)	20.67	8.79	(0.56)	7.65	34.31	18.50	(0.06)	20.70	39.08
Russell:2000 Index	▲ B	(11.01)	14.65	21.31	(4.41)	4.89	38.82	16.35	(4.18)	26.85	27.17
Russell MC/ACWI Ex-US*	◆ C	(11.04)	21.68	10.28	(3.66)	6.11	27.64	17.27	(5.76)	20.98	40.84

Returns for 12 Quarter Rolling Periods
5 Years Ended December 31, 2018
Group: Total Domestic Equity Mutual Funds

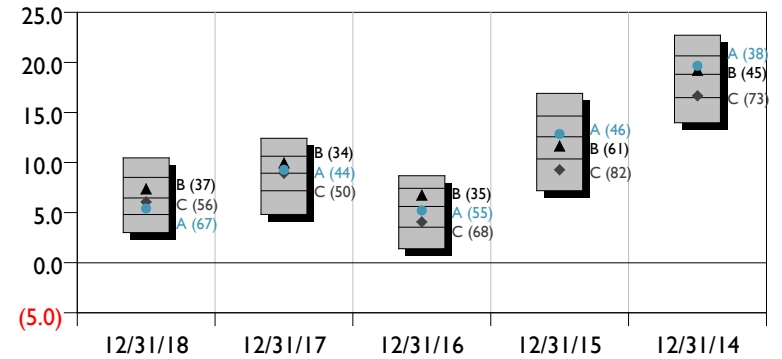

10th Percentile	10.47	12.43	8.69	16.92	22.72
25th Percentile	8.52	10.63	7.43	14.65	20.65
Median	6.47	8.94	5.61	12.57	18.81
75th Percentile	4.82	7.18	3.54	10.35	16.48
90th Percentile	3.02	4.83	1.41	7.20	13.98

Fidelity Low-Prd Stk	● A	5.42	9.29	5.21	12.87	19.66
Russell:2000 Index	▲ B	7.36	9.96	6.74	11.65	19.21
Russell MC/ACWI Ex-US*	◆ C	6.08	8.93	4.08	9.28	16.67

Statistics relative to Russell:2000 Index
for 5 Years Ended December 31, 2018

Statistics relative to Russell:2000 Index
for 5 Years Ended December 31, 2018
Group: Total Domestic Equity Mutual Funds

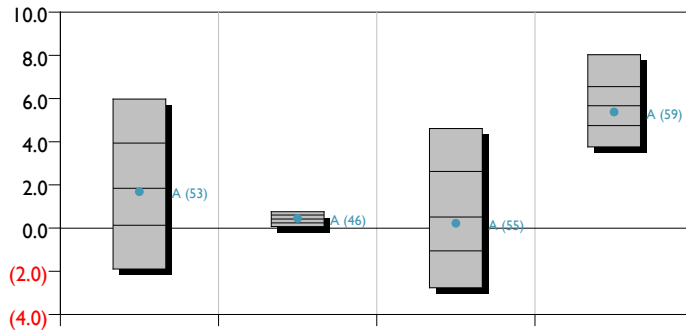

10th Percentile	5.98	0.76	4.61	8.03
25th Percentile	3.94	0.60	2.62	6.55
Median	1.84	0.42	0.51	5.66
75th Percentile	0.13	0.24	(1.06)	4.75
90th Percentile	(1.89)	0.08	(2.76)	3.77

Fidelity Low-Prd Stk	● A	1.69	0.45	0.22	5.38
----------------------	-----	------	------	------	------

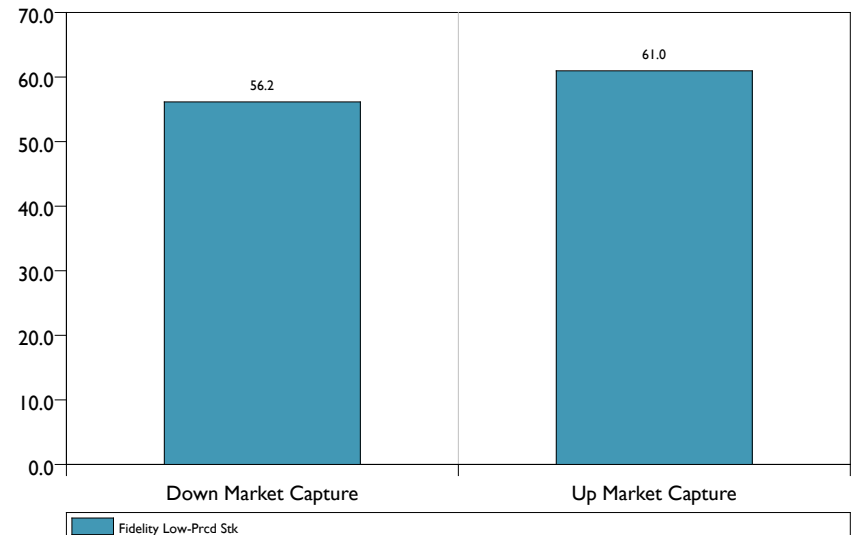

**FIDELITY DIVERSIFIED INTERNATIONAL
STYLE: INTERNATIONAL
YEAR ENDED DECEMBER 31, 2018**

Organization		Fidelity
Product Name	Diversified International	
Product Inception Date	December 27, 1991	
Ownership Structure	Fidelity Management & Research Company (FMR Co.), the investment advisor to Fidelity's family of mutual funds.	
Firm Information	Located in Boston, MA; Founded in 1946 with over \$2.4 trillion in assets under management.	
Investment Philosophy	Invests primarily in large cap non-U.S. stocks, but will occasionally invest in mid and small cap issues. The manager uses a growth-at-a-reasonable price strategy to identify securities for the portfolio.	
# of holdings	210	
% in Top Ten	14%	
Turnover	48%	
Index	MSCI EAFE Index	
Benchmark Awareness	Generally, the portfolio's sector allocation track the MSCI EAFE index, with a modest allocation to emerging markets securities.	
Weighted Avg market cap	\$63.2 billion	
Price/Earnings	17.1	
Key Professionals	William Bower	
Assets In Product	\$12.9 billion	
Fees	60 bps	
Vehicle Type	Mutual Fund (FKIDX)	

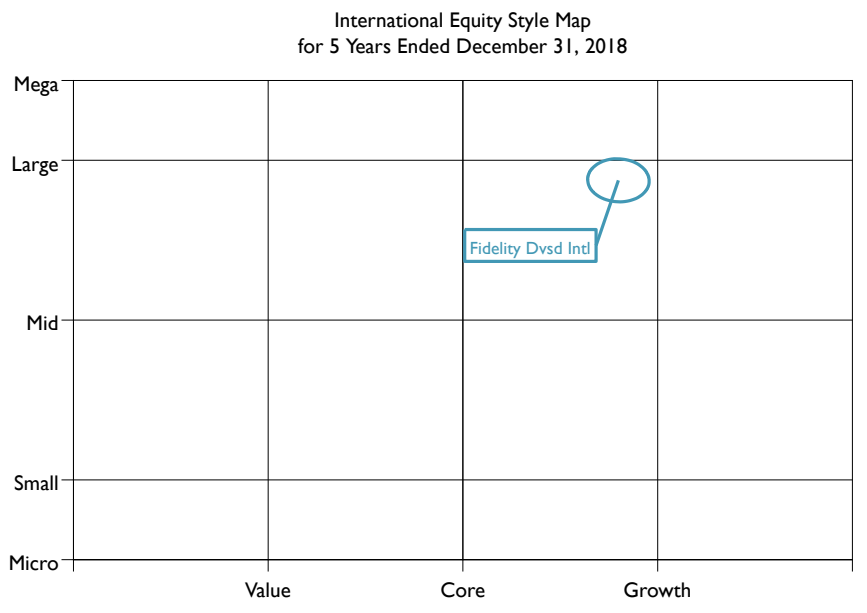

**Rolling 12 Quarter Scatter Chart for 5 Years
Ended December 31, 2018**

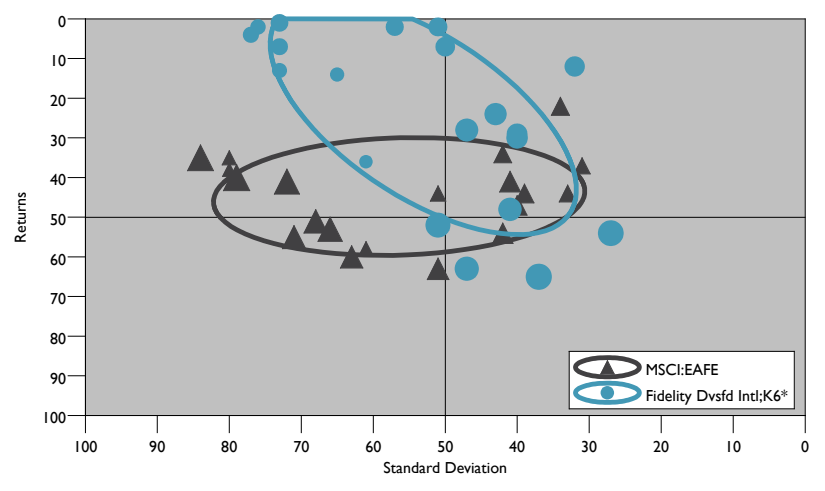

	December 31, 2018 Market Value	% of Plan Assets
Fidelity Diversified International	\$43,696,662	3.6%



FIDELITY DIVERSIFIED INTERNATIONAL STYLE: INTERNATIONAL YEAR ENDED DECEMBER 31, 2018

Returns for Calendar Years
10 Years Ended December 31, 2018
Group: Callan Intl Eq Developed Mkts MFs

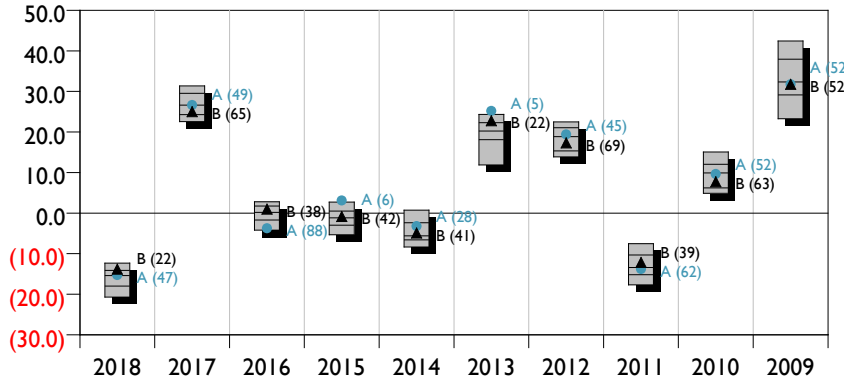

10th Percentile	(12.32)	31.37	2.83	2.73	0.74	24.36	22.52	(7.51)	15.09	42.44	
25th Percentile	(14.11)	29.55	1.73	0.51	(2.36)	22.31	21.04	(10.32)	12.04	37.96	
Median	(15.38)	26.64	0.19	(1.17)	(5.61)	20.24	18.86	(13.41)	9.89	32.33	
75th Percentile	(18.00)	24.29	(1.68)	(2.97)	(6.60)	18.11	15.34	(15.18)	6.20	29.16	
90th Percentile	(20.69)	22.59	(4.19)	(5.31)	(8.32)	11.90	13.87	(17.65)	4.91	23.30	
Fidelity Dvds Intl	● A	(15.24)	26.65	(3.73)	3.12	(3.20)	25.19	19.41	(13.78)	9.65	31.78
MSCI:EAFE	▲ B	(13.79)	25.03	1.00	(0.81)	(4.90)	22.78	17.32	(12.14)	7.75	31.78

Returns for 12 Quarter Rolling Periods
5 Years Ended December 31, 2018
Group: Callan Intl Eq Developed Mkts MFs

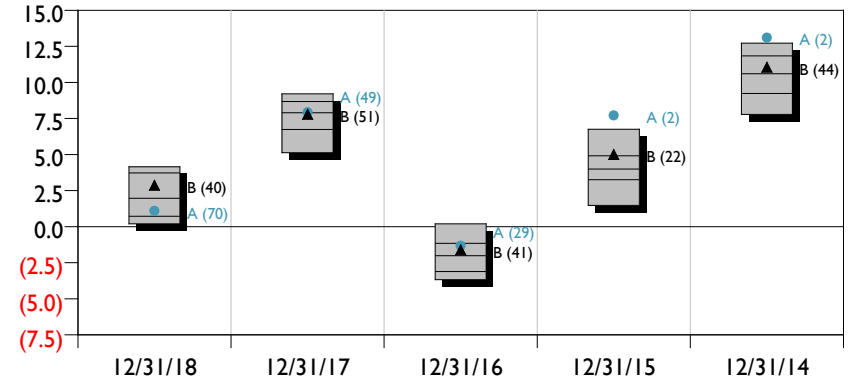

10th Percentile	4.16	9.22	0.20	6.76	12.73	
25th Percentile	3.72	8.68	(1.16)	4.91	11.84	
Median	1.97	7.90	(2.01)	4.00	10.61	
75th Percentile	0.72	6.74	(3.11)	3.26	9.24	
90th Percentile	0.20	5.13	(3.68)	1.48	7.79	
Fidelity Dvds Intl	● A	1.10	7.93	(1.32)	7.71	13.11
MSCI:EAFE	▲ B	2.87	7.80	(1.60)	5.01	11.06

Statistics relative to MSCI:EAFE
for 5 Years Ended December 31, 2018
Group: Callan Intl Eq Developed Mkts MFs

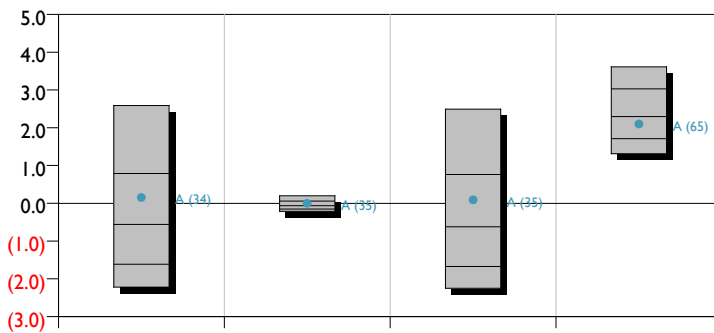

10th Percentile	2.59	0.20	2.50	3.61
25th Percentile	0.79	0.06	0.76	3.03
Median	(0.56)	(0.06)	(0.62)	2.29
75th Percentile	(1.61)	(0.15)	(1.67)	1.71
90th Percentile	(2.22)	(0.21)	(2.25)	1.31
Fidelity Dvds Intl	● A	0.16	0.09	2.10
MSCI:EAFE	▲ B	(0.56)	(0.62)	(2.29)

Statistics relative to MSCI:EAFE
for 5 Years Ended December 31, 2018

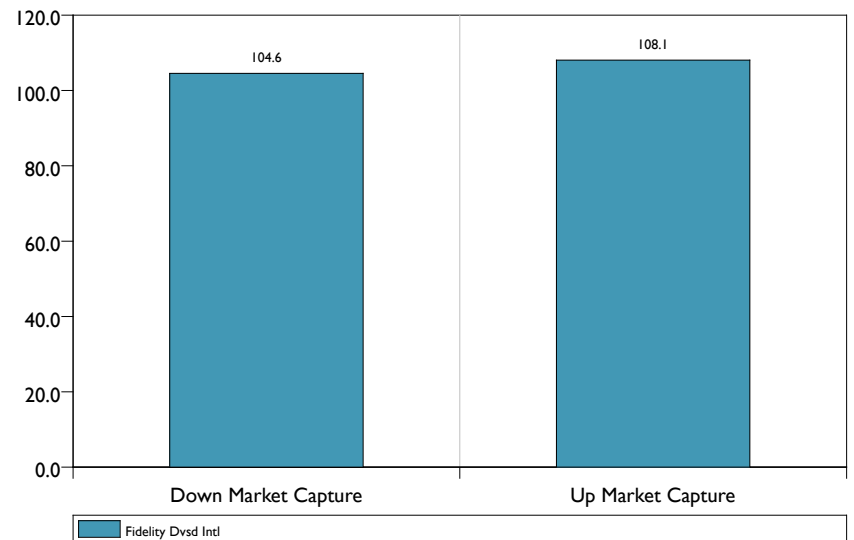

**AMERICAN FUNDS EUROPACIFIC GROWTH
STYLE: INTERNATIONAL
YEAR ENDED DECEMBER 31, 2018**

Organization	American Funds
Product Name	EuroPacific Growth
Product Inception Date	April 16, 1984
Ownership Structure	Part of the Capital Group Companies; Employee Owned
Firm Information	Founded in 1931 with more than \$1.5 trillion in assets under management. Capital Research & Management Co. is investment advisor.
Investment Philosophy	The fund utilizes a multi-portfolio manager system (eight portfolio managers and a research portfolio) where each PM has sole discretion within their sleeve of the portfolio. 20% of the portfolio is invested in the Research Portfolio which is run by 30-40 of the firm's sector analysts.
# of holdings	260
% in Top Ten	20%
Turnover	29%
Index	MSCI All Country World ex USA Index
Benchmark Awareness	Country and Sector weights are the residual of bottom-up decisions and the aggregation of the underlying 9 sleeves. The portfolio will make significant use (25%+) of non-benchmark companies. Approximately 25% Emerging Markets.
Weighted Avg market cap	\$66.0 billion
Price/Earnings	12.9
Key Professionals	Denning/Lyckeus/Grace/ Kawaja/Lee/Knowles/Kymisis/Suzman/Thomsen
Assets In Product	\$138.4 billion
Fees	49 bps
Vehicle Type	Mutual Fund (RERGX)

	December 31, 2018 Market Value	% of Plan Assets
American Funds EuroPacific Growth	\$43,350,171	3.6%

International Equity Style Map
for 5 Years Ended December 31, 2018

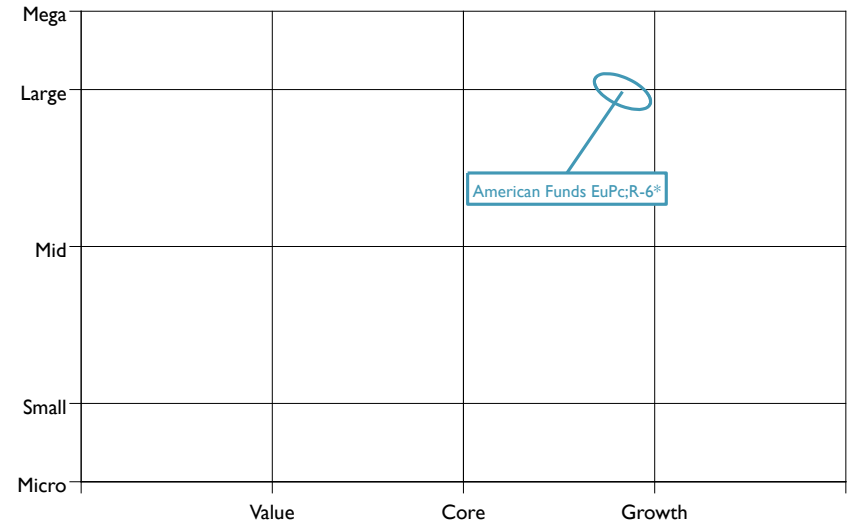

Rolling 12 Quarter Scatter Chart for 5 Years
Ended December 31, 2018

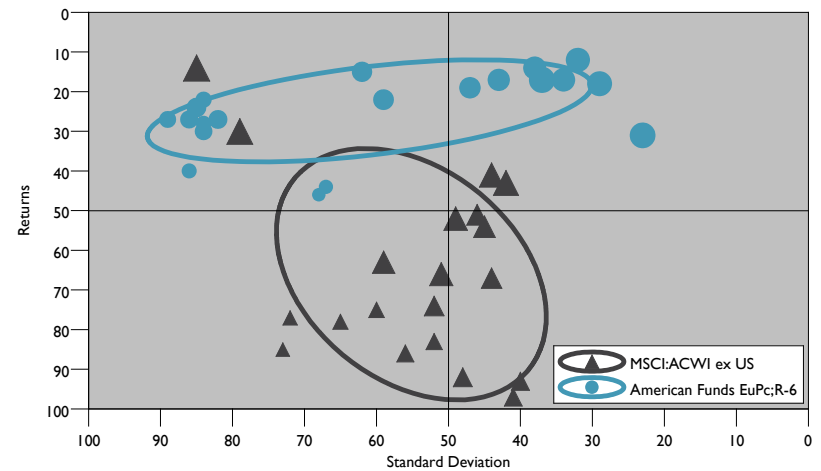

AMERICAN FUNDS EUROPACIFIC GROWTH STYLE: INTERNATIONAL YEAR ENDED DECEMBER 31, 2018

Returns for Calendar Years
10 Years Ended December 31, 2018
Group: Callan Non US Equity Mutual Funds

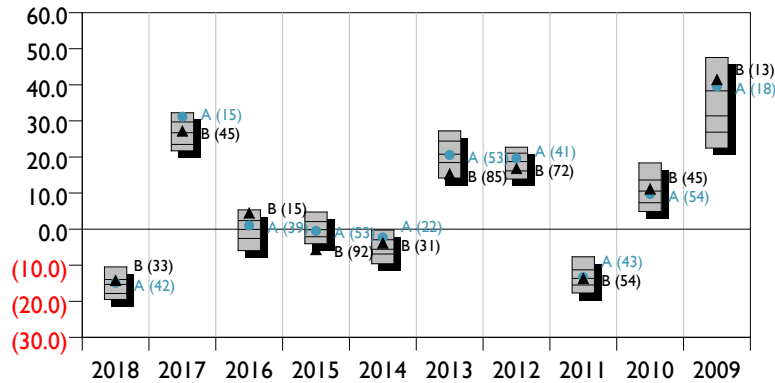

10th Percentile	(10.44)	32.28	5.37	4.77	(0.24)	27.22	22.74	(7.66)	18.37	47.59
25th Percentile	(13.99)	29.72	2.38	2.07	(2.96)	24.39	21.04	(11.28)	13.61	38.33
Median	(15.33)	26.73	(0.09)	(0.15)	(5.60)	20.76	18.72	(13.63)	10.56	31.38
75th Percentile	(17.83)	23.49	(2.60)	(2.12)	(6.91)	18.47	16.14	(15.49)	7.31	26.89
90th Percentile	(19.47)	21.74	(5.95)	(4.01)	(9.57)	14.18	13.91	(17.68)	4.91	22.49

American Funds EuPc;R-6*	● A	(14.91)	31.17	1.01	(0.48)	(2.29)	20.58	19.64	(13.31)	9.76	39.56
MSCI:ACWI ex US	▲ B	(14.20)	27.19	4.50	(5.66)	(3.87)	15.29	16.83	(13.71)	11.15	41.45

Returns
for 12 Quarter Rolling Periods
5 Years Ended December 31, 2018
Group: Callan Non US Equity Mutual Funds

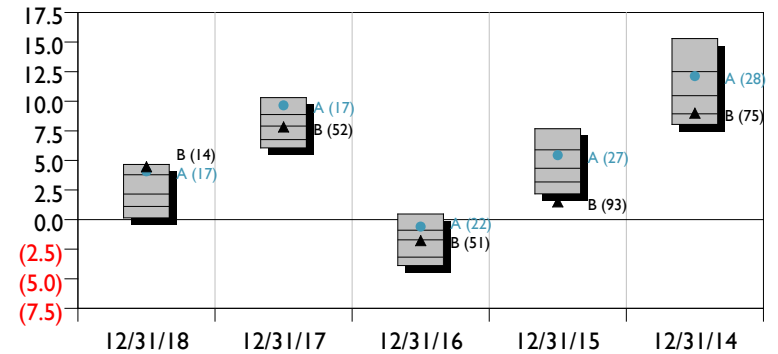

10th Percentile	4.67	10.31	0.48	7.68	15.30
25th Percentile	3.79	8.87	(0.90)	5.89	12.50
Median	2.16	7.90	(1.71)	4.34	10.47
75th Percentile	1.11	6.76	(3.17)	3.18	8.94
90th Percentile	0.15	6.06	(3.88)	2.18	8.05

American Funds EuPc;R-6*	● A	4.08	9.66	(0.60)	5.45	12.12
MSCI:ACWI ex US	▲ B	4.48	7.83	(1.78)	1.50	8.99

Statistics relative to MSCI:ACWI ex US
for 5 Years Ended December 31, 2018

Statistics relative to MSCI:ACWI ex US
for 5 Years Ended December 31, 2018
Group: Callan Non US Equity Mutual Funds

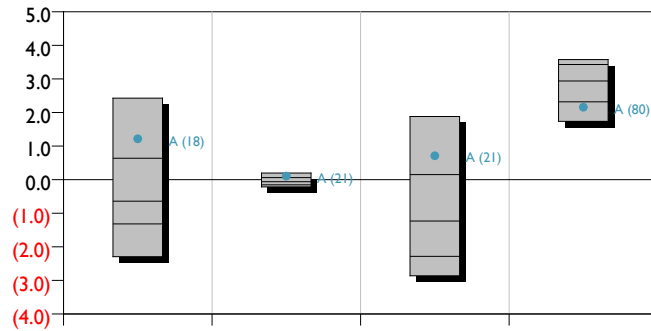

10th Percentile	2.43	0.20	1.88	3.58
25th Percentile	0.64	0.06	0.15	3.43
Median	(0.64)	(0.06)	(1.23)	2.94
75th Percentile	(1.32)	(0.15)	(2.28)	2.32
90th Percentile	(2.29)	(0.21)	(2.86)	1.74

American Funds EuPc;R-6*	● A	1.22	0.11	0.71	2.16
--------------------------	-----	------	------	------	------

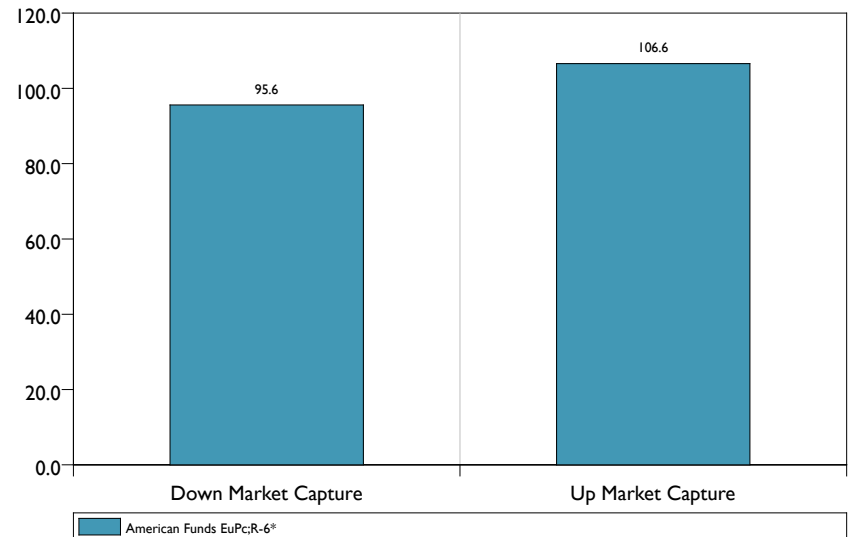

INDIANA 2060 FUND STYLE: LIFESTYLE YEAR ENDED DECEMBER 31, 2018

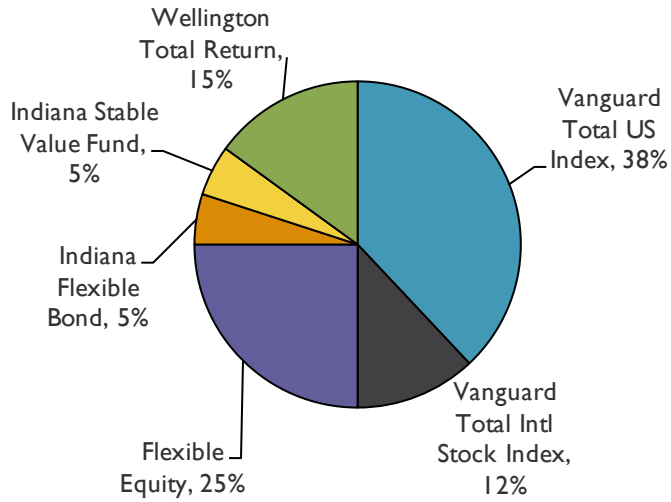

December 31, 2018		% of Plan Assets
Market Value		
Indiana 2060 Fund	\$6,051,615	0.5%

Rolling 12 Quarter Scatter Chart for 5 Years Ended December 31, 2018

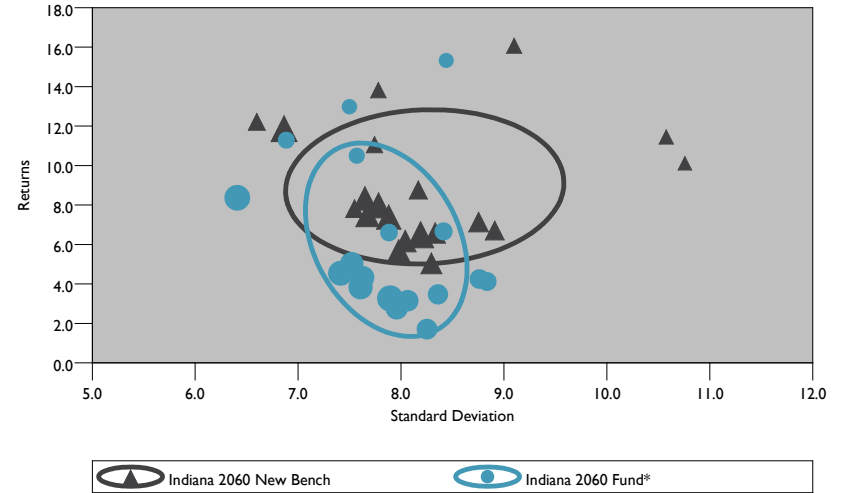

**Returns for Calendar Years
5 Years Ended December 31, 2018**

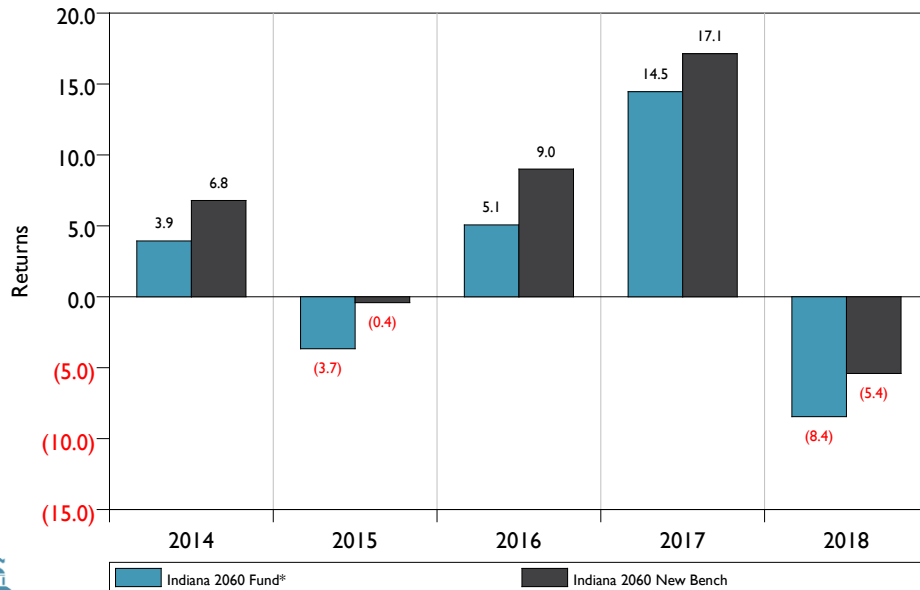

**Rolling 3 Year Returns
for 4 Years Ended December 31, 2018**

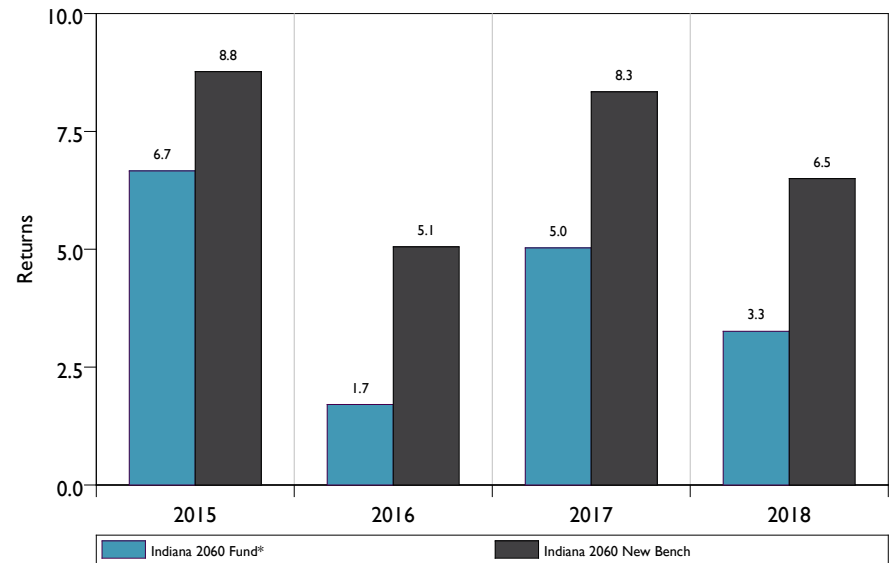

*The inception date of the Indiana 2060 Fund is August 21, 2015.



INDIANA 2055 FUND STYLE: LIFESTYLE YEAR ENDED DECEMBER 31, 2018

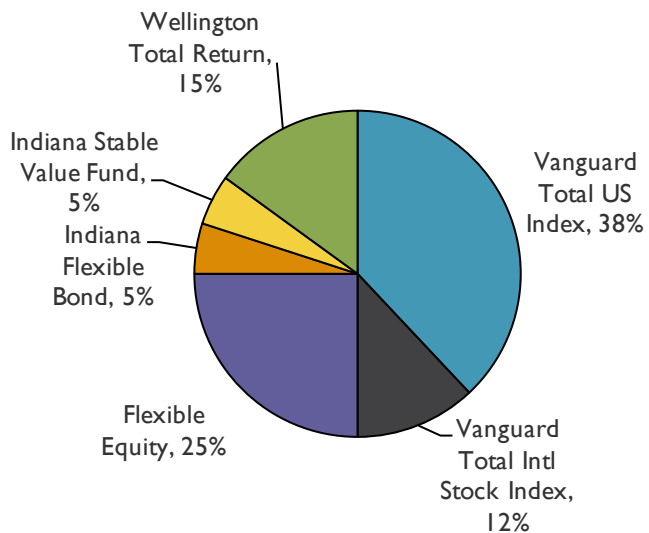

December 31, 2018		% of Plan Assets
Market Value		
Indiana 2055 Fund	\$5,023,954	0.4%

Returns for Calendar Years
10 Years Ended December 31, 2018

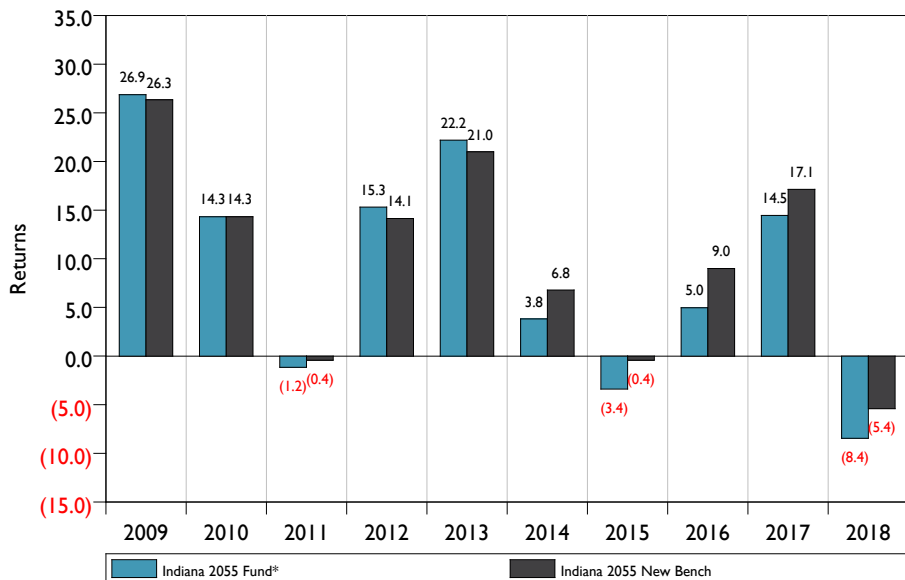

*The inception date of the Indiana 2055 Fund is January 1, 2013.

Rolling 12 Quarter Scatter Chart for 5 Years
Ended December 31, 2018

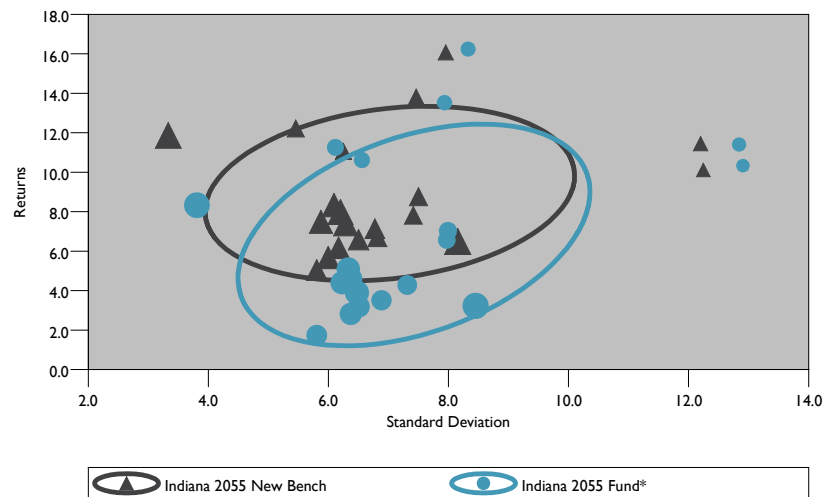

Rolling 3 Year Returns
for 5 Years Ended December 31, 2018

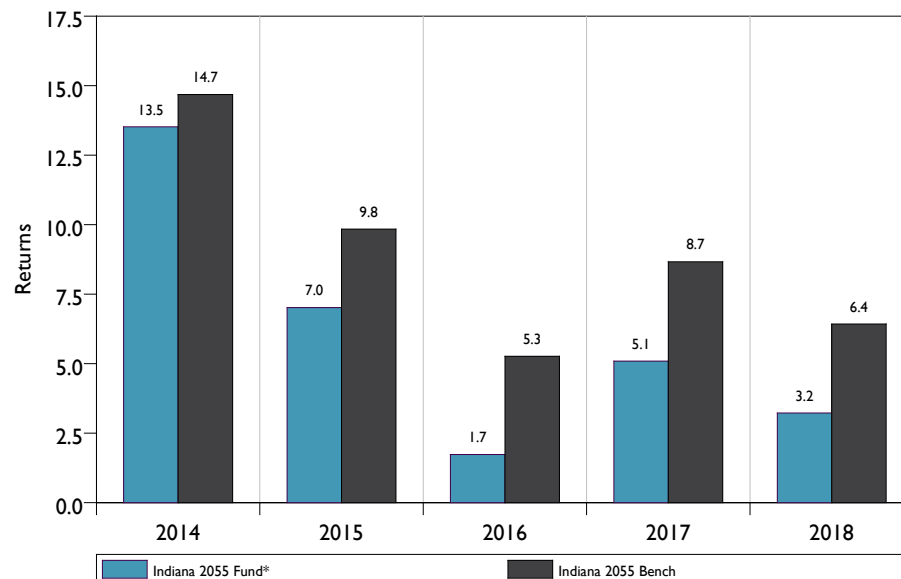

INDIANA 2050 FUND STYLE: LIFESTYLE YEAR ENDED DECEMBER 31, 2018

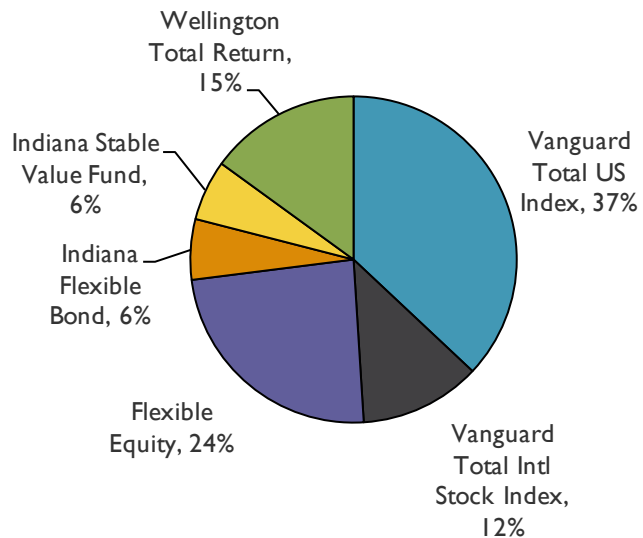

December 31, 2018		% of Plan
Market Value	Assets	
Indiana 2050 Fund	\$17,514,145	1.5%

Returns for Calendar Years
10 Years Ended December 31, 2018

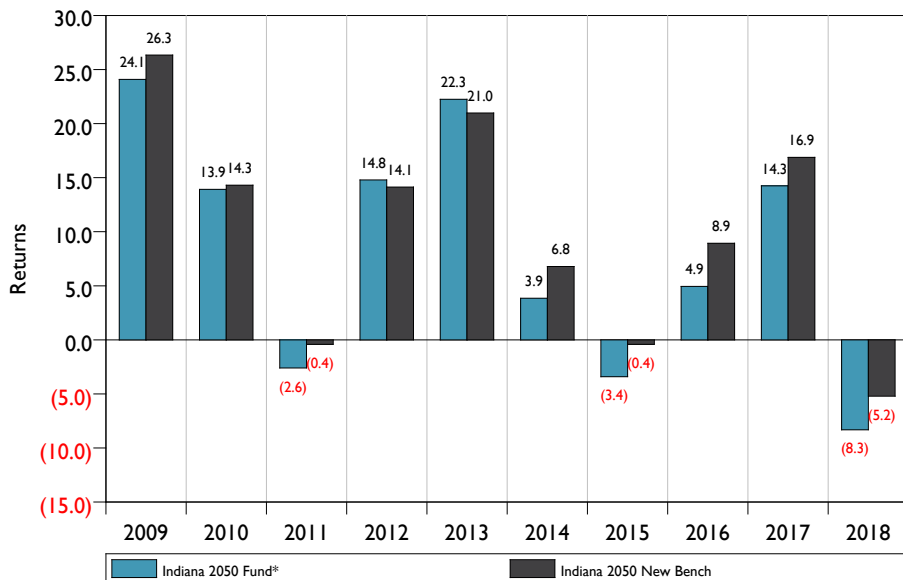

*The inception date of the Indiana 2050 Fund is January 27, 2011.

Rolling 12 Quarter Scatter Chart for 5 Years
Ended December 31, 2018

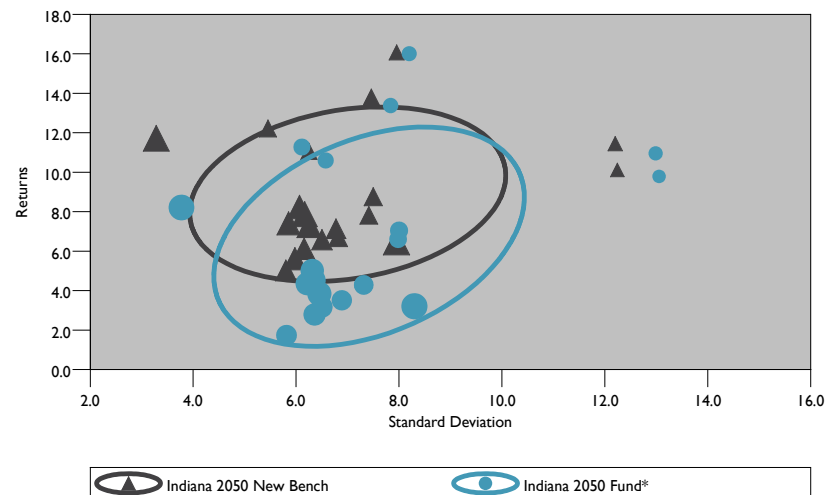

Rolling 3 Year Returns
for 5 Years Ended December 31, 2018

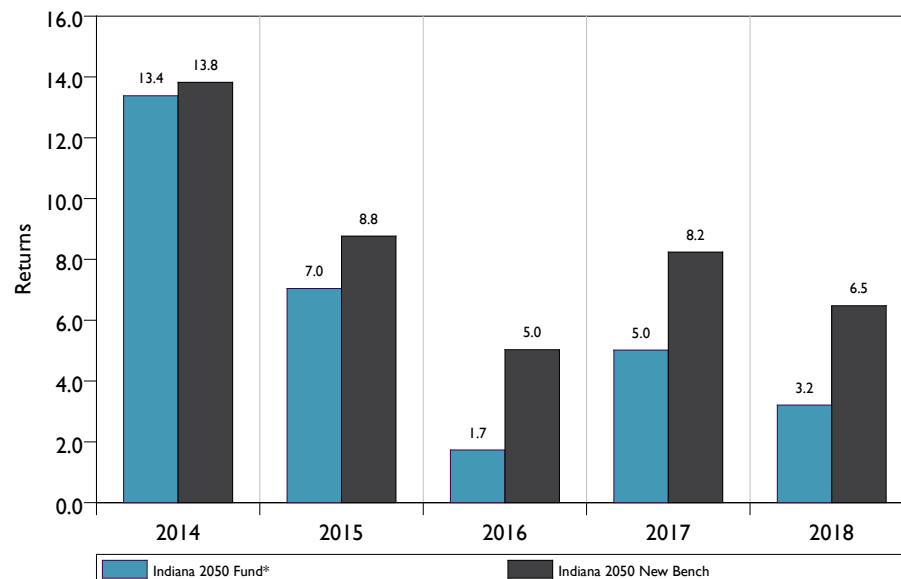

INDIANA 2045 FUND STYLE: LIFESTYLE YEAR ENDED DECEMBER 31, 2018

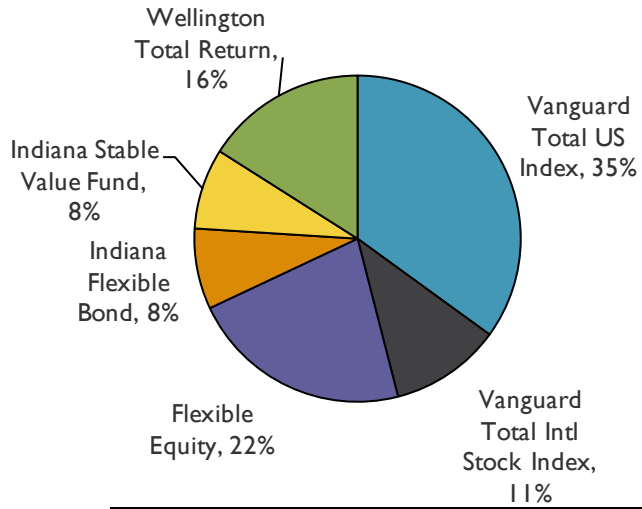

December 31, 2018		% of Plan
Market Value		Assets
Indiana 2045 Fund	\$28,562,156	2.4%

**Rolling 12 Quarter Scatter Chart for 5 Years
Ended December 31, 2018**

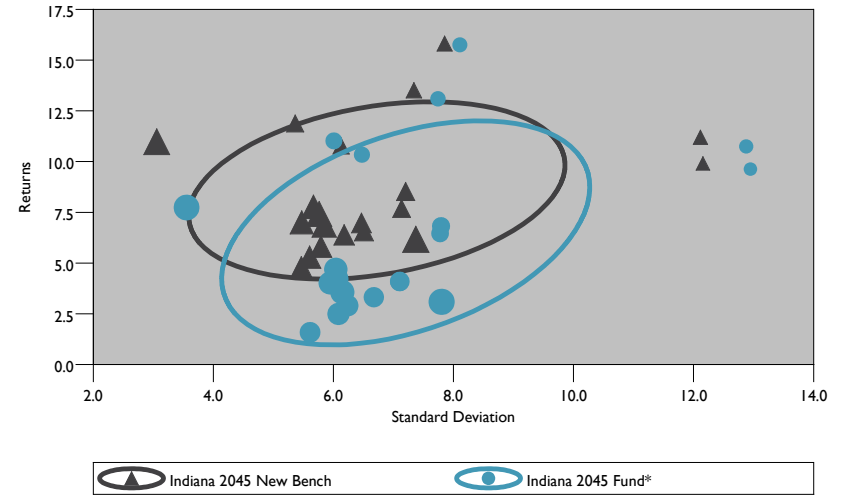

**Returns for Calendar Years
10 Years Ended December 31, 2018**

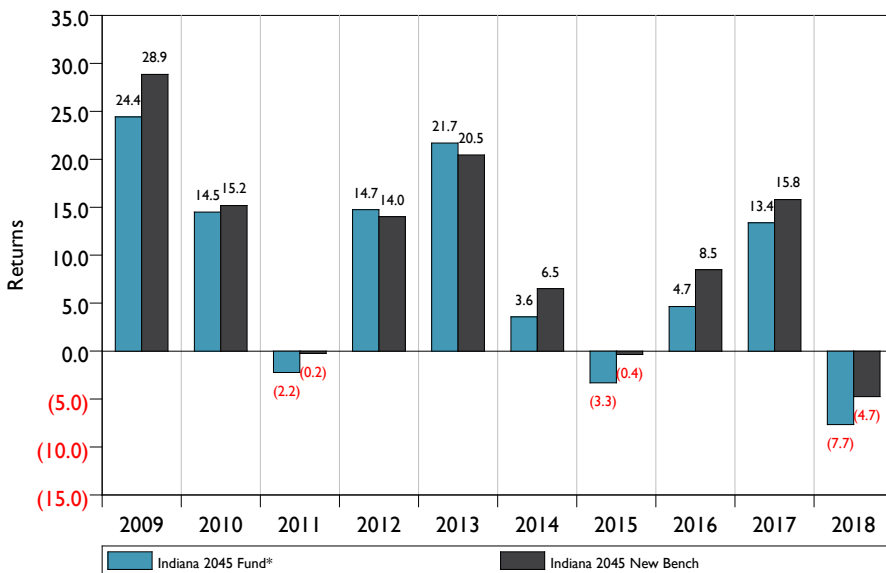

**Rolling 3 Year Returns
for 5 Years Ended December 31, 2018**

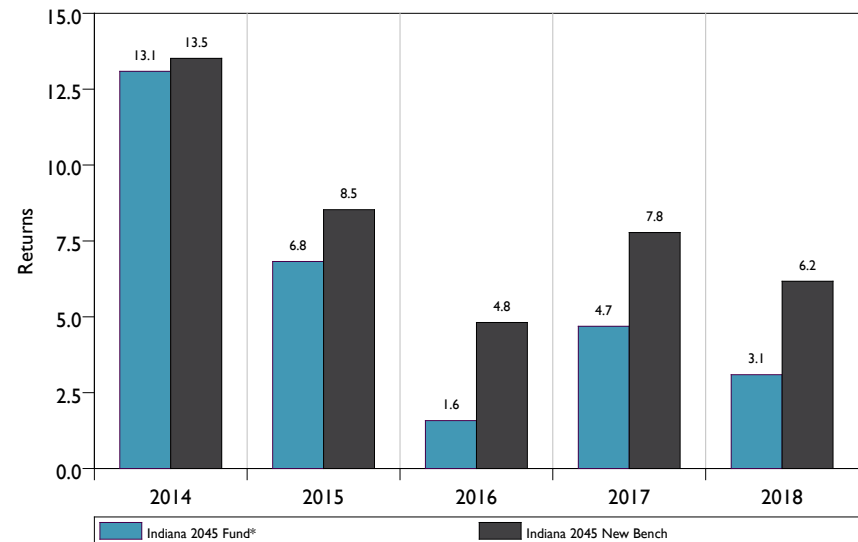

*The inception date of the Indiana 2045 Fund is August 6, 2007.



INDIANA 2040 FUND STYLE: LIFESTYLE YEAR ENDED DECEMBER 31, 2018

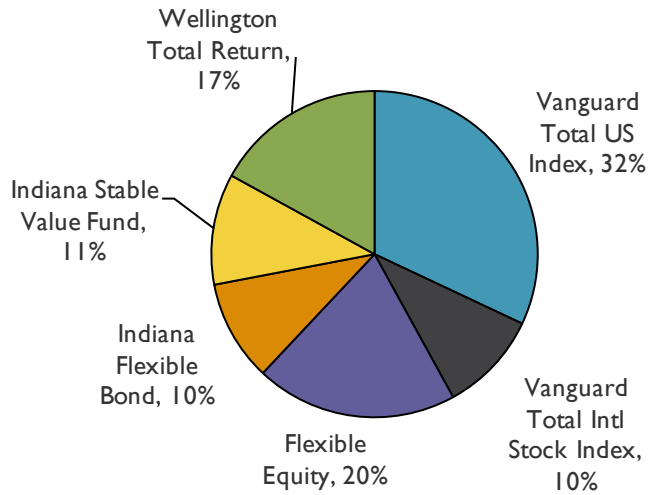

December 31, 2018		% of Plan Assets
Market Value		
Indiana 2040 Fund	\$10,964,173	0.9%

Rolling 12 Quarter Scatter Chart for 5 Years Ended December 31, 2018

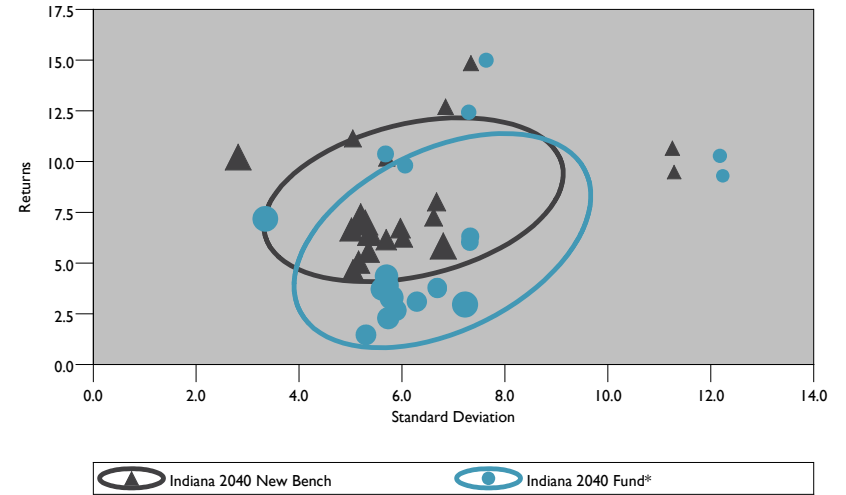

Returns for Calendar Years
10 Years Ended December 31, 2018

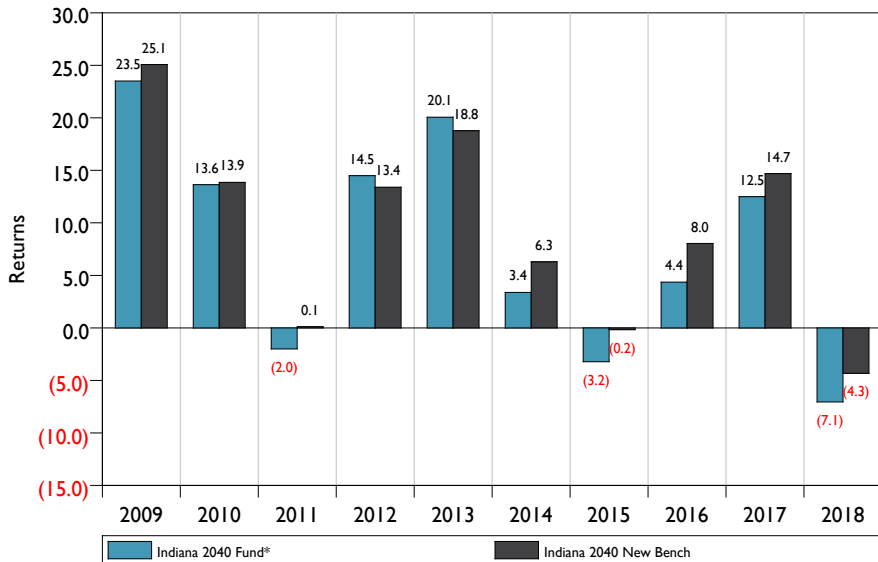

Rolling 3 Year Returns
for 5 Years Ended December 31, 2018

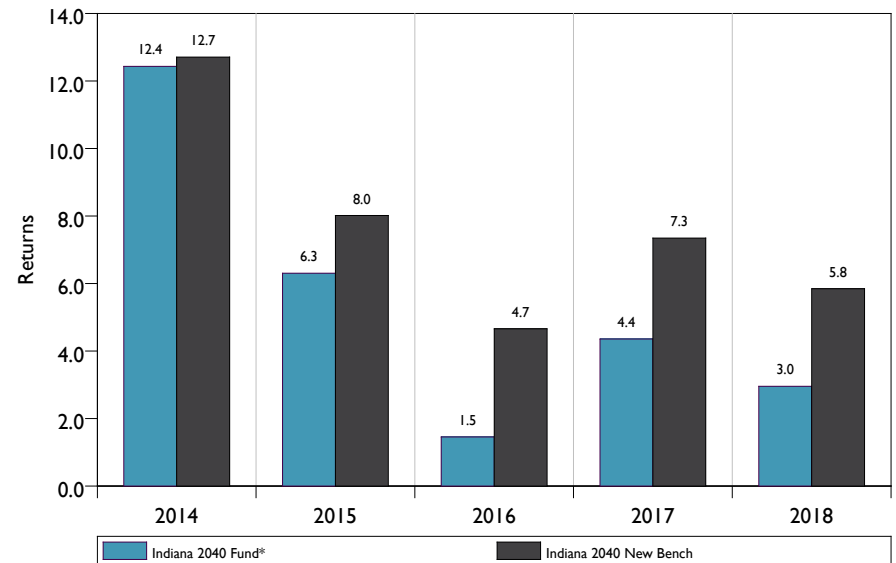

*The inception date of the Indiana 2040 Fund is January 27, 2011.



INDIANA 2035 FUND STYLE: LIFESTYLE YEAR ENDED DECEMBER 31, 2018

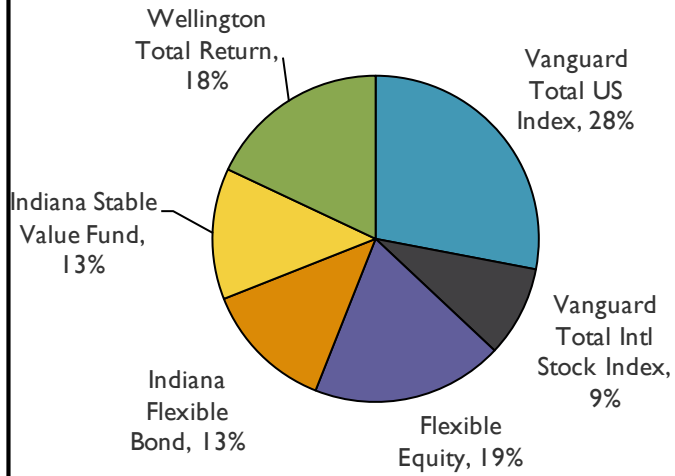

	December 31, 2018 Market Value	% of Plan Assets
Indiana 2035 Fund	\$32,132,421	2.7%

**Rolling 12 Quarter Scatter Chart for 5 Years
Ended December 31, 2018**

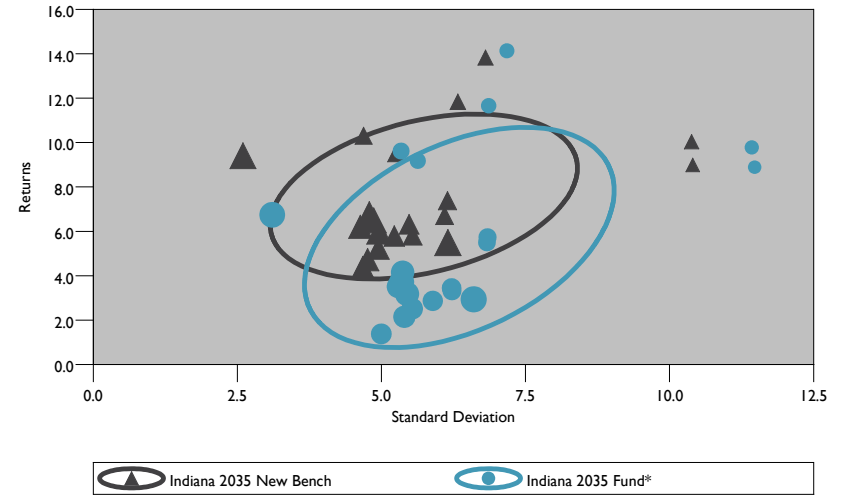

**Returns for Calendar Years
10 Years Ended December 31, 2018**

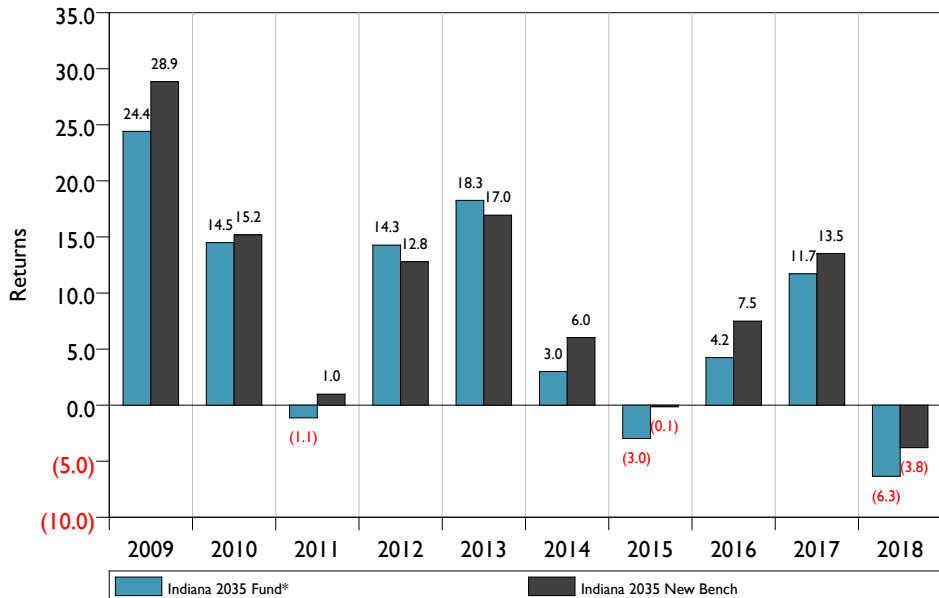

**Rolling 3 Year Returns
for 5 Years Ended December 31, 2018**

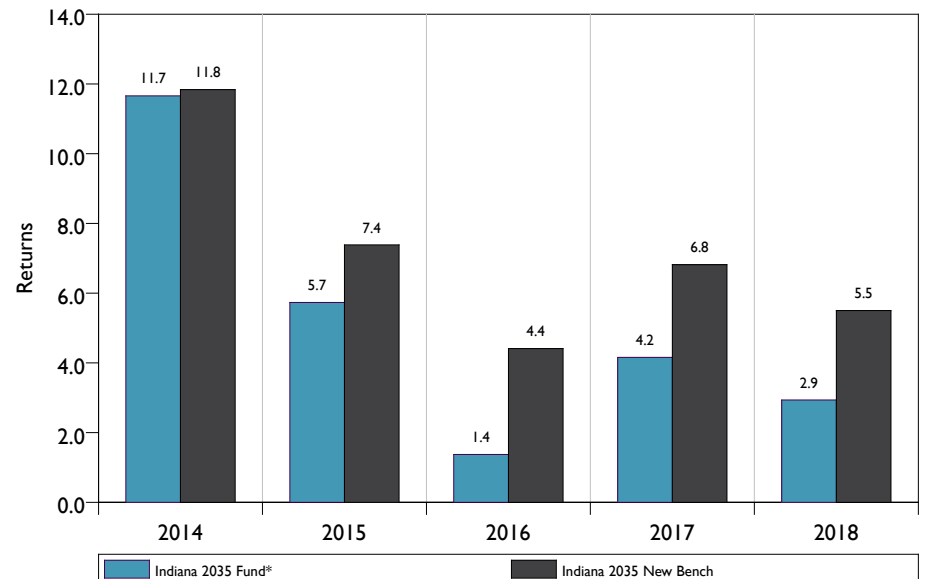

*The inception date of the Indiana 2035 Fund is August 6, 2007.



INDIANA 2030 FUND STYLE: LIFESTYLE YEAR ENDED DECEMBER 31, 2018

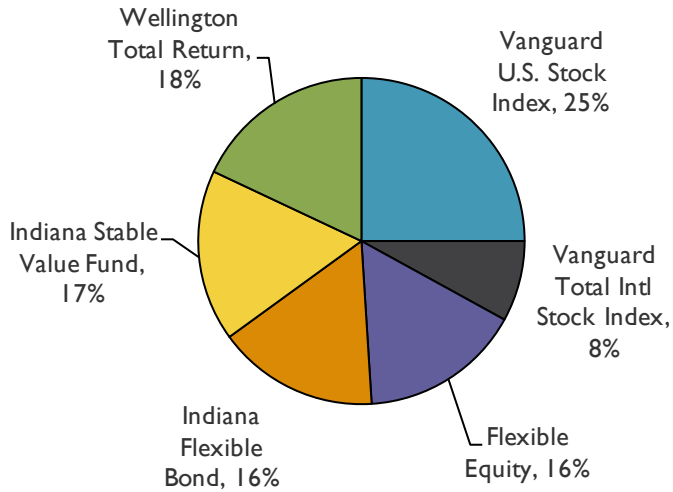

	December 31, 2018 Market Value	% of Plan Assets
Indiana 2030 Fund	\$13,142,318	1.1%

**Rolling 12 Quarter Scatter Chart for 5 Years
Ended December 31, 2018**

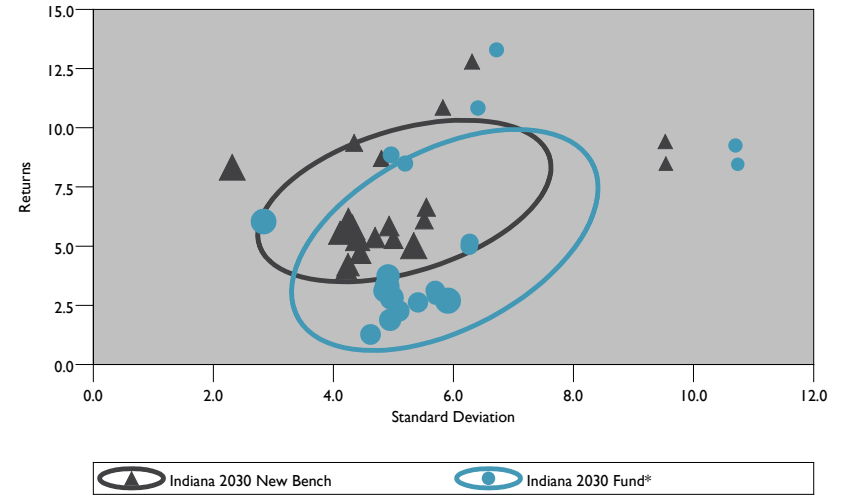

Returns for Calendar Years
10 Years Ended December 31, 2018

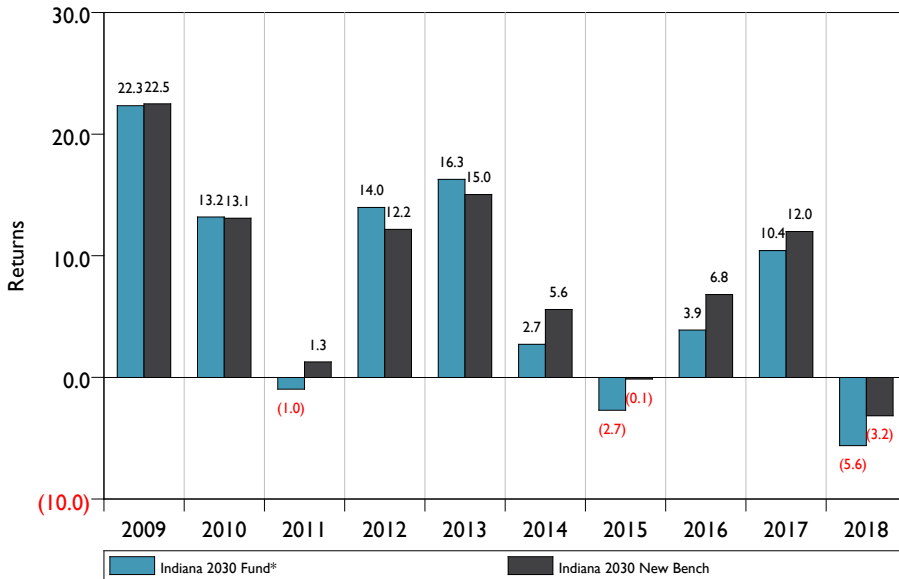

Rolling 3 Year Returns
for 5 Years Ended December 31, 2018

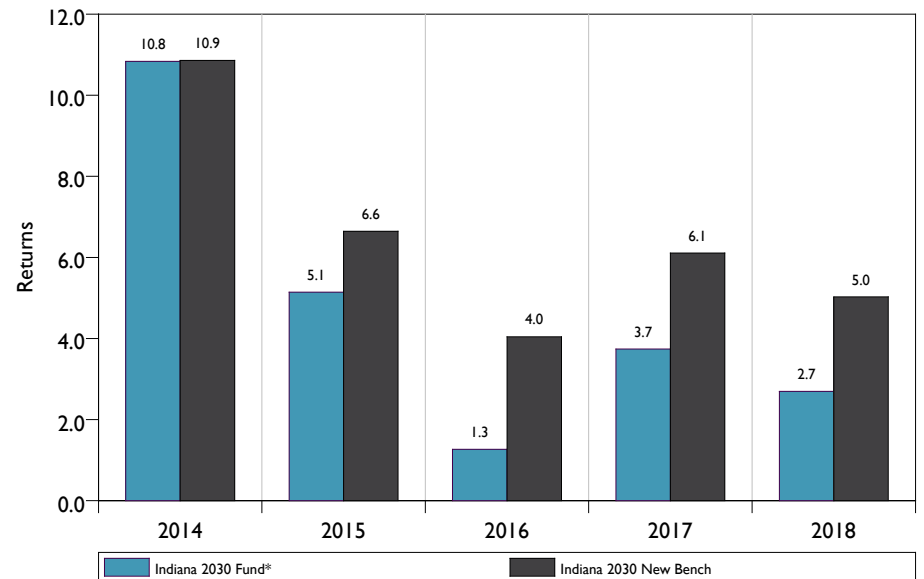

*The inception date of the Indiana 2030 Fund is January 27, 2011.



INDIANA 2025 FUND STYLE: LIFESTYLE YEAR ENDED DECEMBER 31, 2018

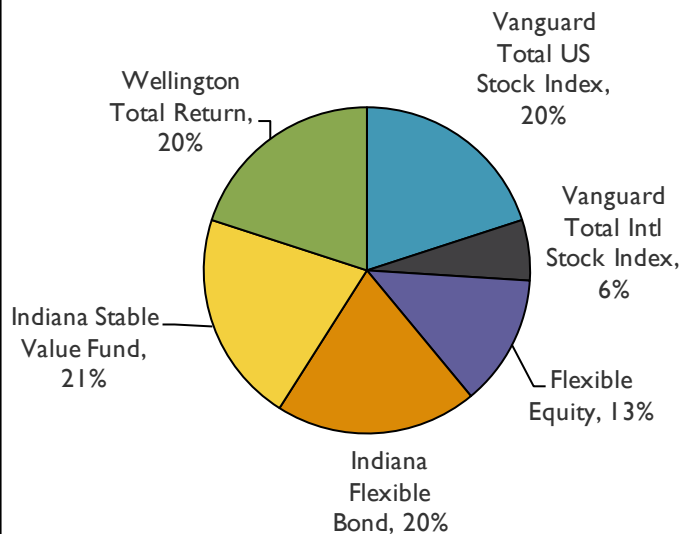

	December 31, 2018 Market Value	% of Plan Assets
Indiana 2025 Fund	\$43,064,116	3.6%

**Rolling 12 Quarter Scatter Chart for 5 Years
Ended December 31, 2018**

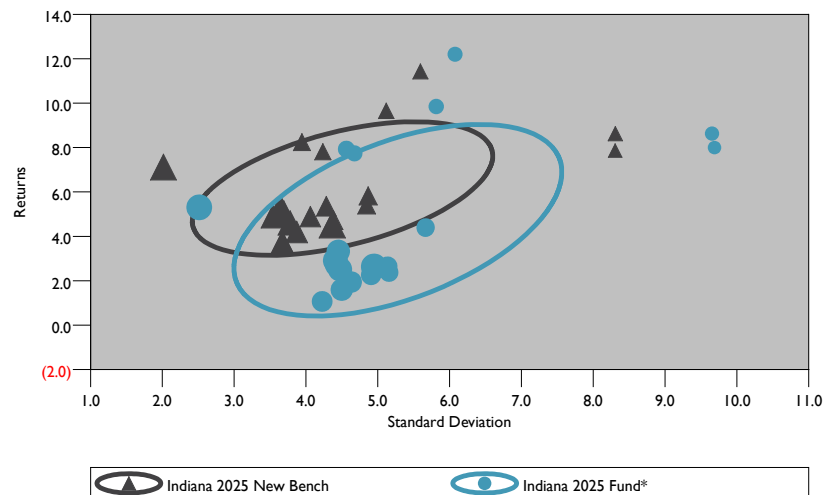

**Returns for Calendar Years
10 Years Ended December 31, 2018**

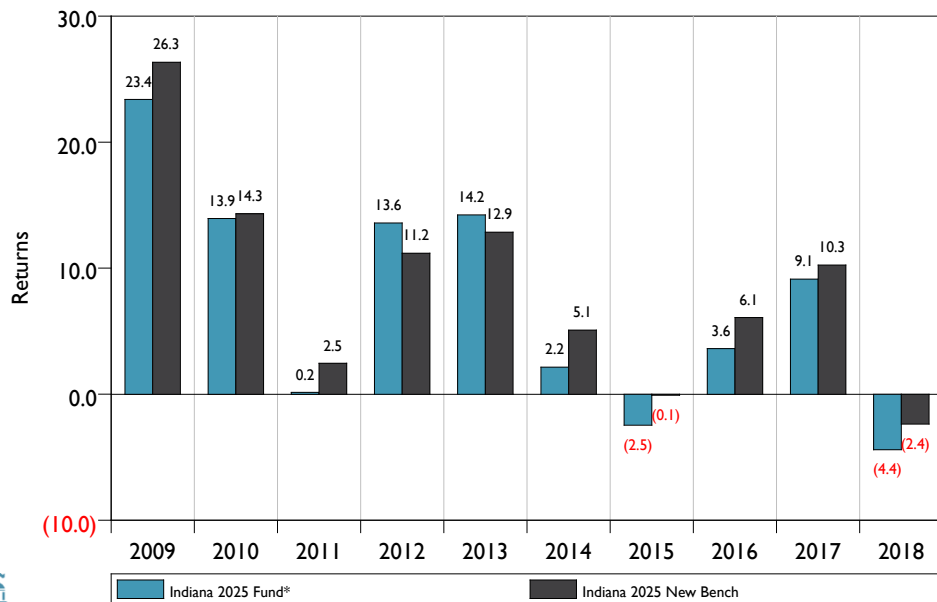

**Rolling 3 Year Returns
for 5 Years Ended December 31, 2018**

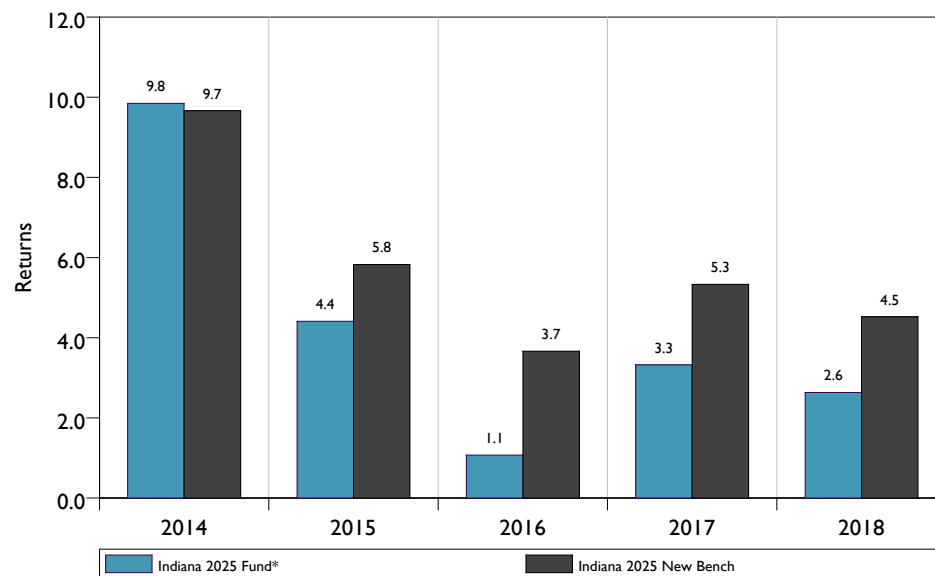

*The inception date of the Indiana 2025 Fund is August 6, 2007.



INDIANA 2020 FUND STYLE: LIFESTYLE YEAR ENDED DECEMBER 31, 2018

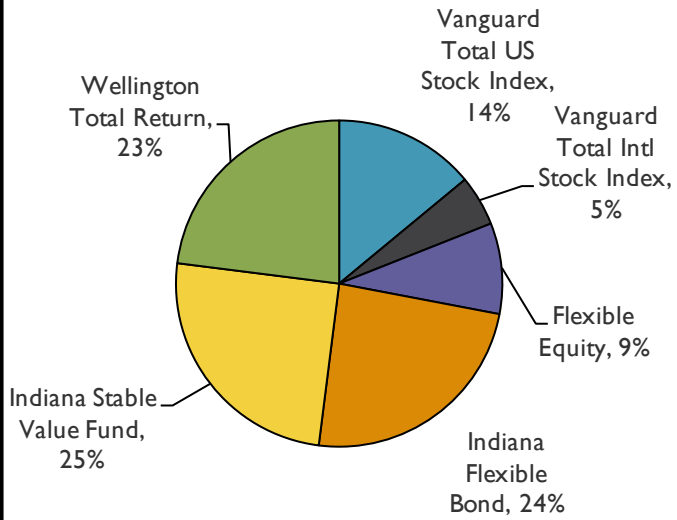

December 31, 2018		% of Plan Assets
Market Value		
Indiana 2020 Fund	\$13,633,091	1.1%

Rolling 12 Quarter Scatter Chart for 5 Years Ended December 31, 2018

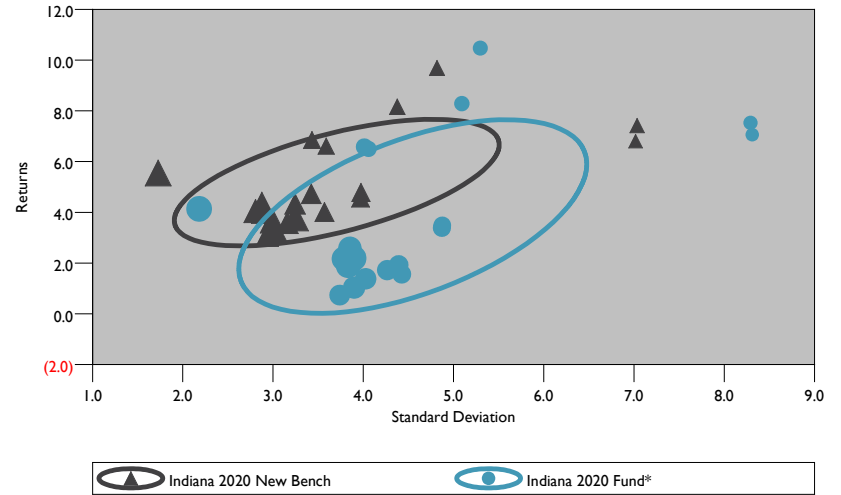

**Returns for Calendar Years
10 Years Ended December 31, 2018**

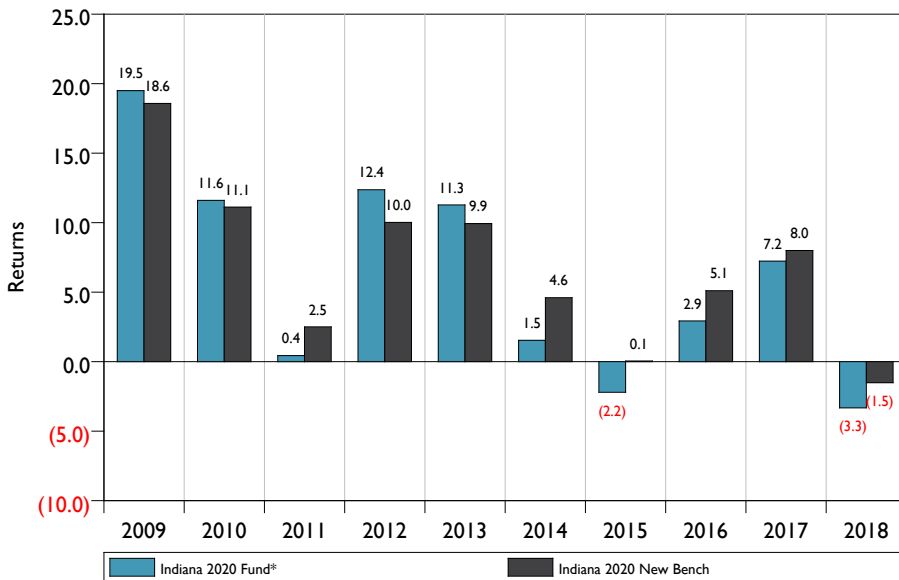

**Rolling 3 Year Returns
for 5 Years Ended December 31, 2018**

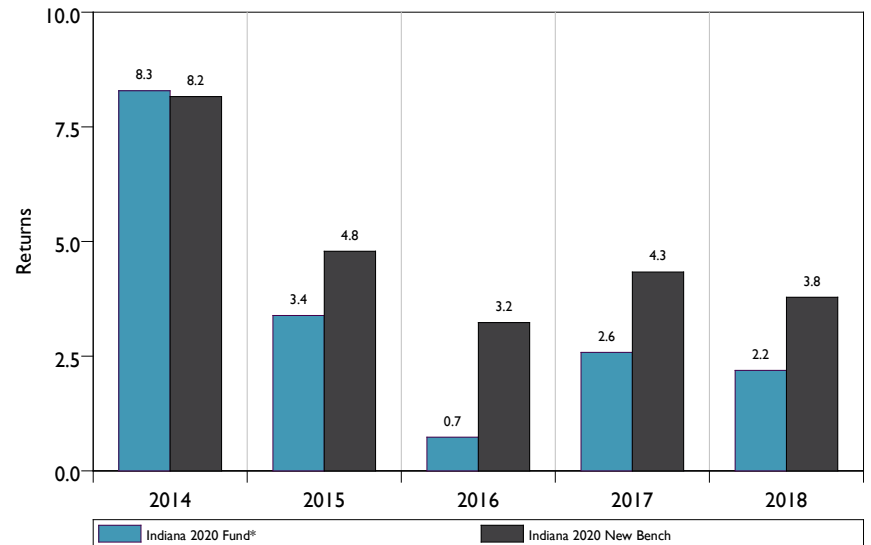

*The inception date of the Indiana 2020 Fund is January 27, 2011.



INDIANA RETIREMENT FUND STYLE: LIFESTYLE YEAR ENDED DECEMBER 31, 2018

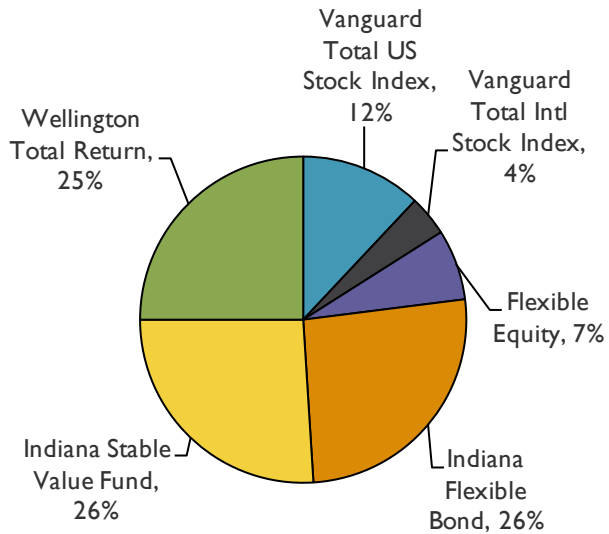

December 31, 2018		% of Plan Assets
Market Value		
Indiana Retirement Fund	\$36,826,485	3.1%

Rolling 12 Quarter Scatter Chart for 5 Years Ended December 31, 2018

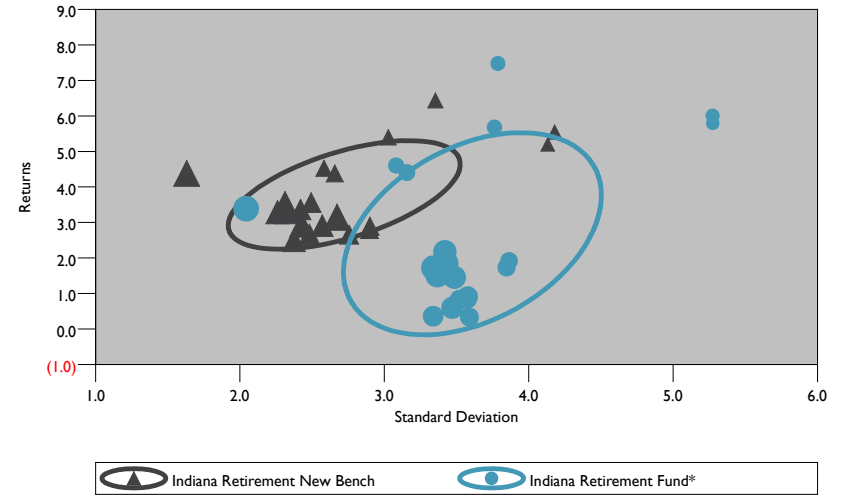

**Returns for Calendar Years
10 Years Ended December 31, 2018**

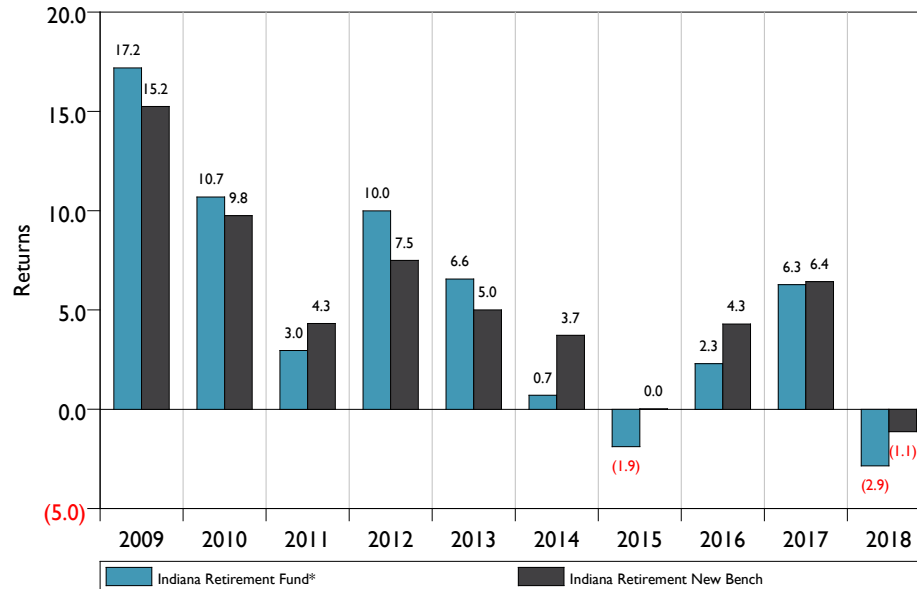

**Rolling 3 Year Returns
for 5 Years Ended December 31, 2018**

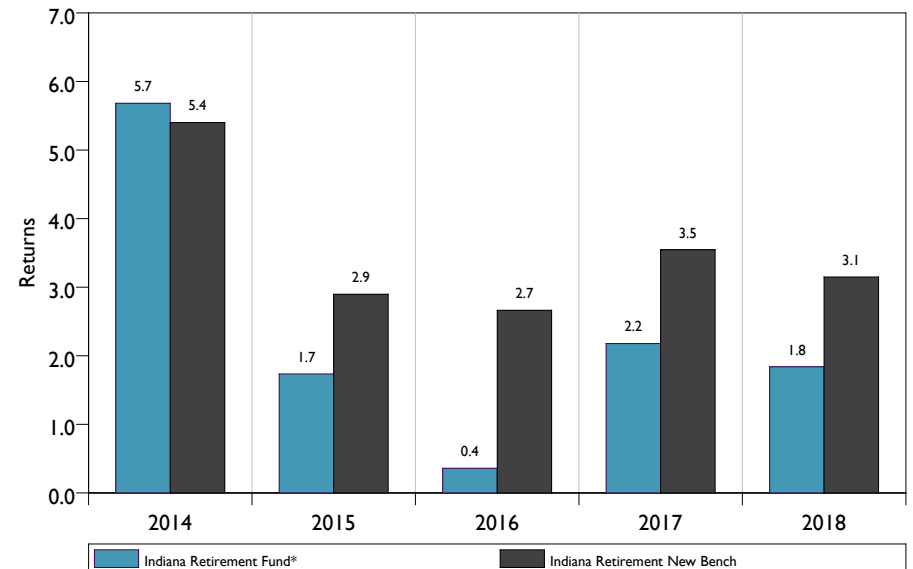

*The inception date of the Indiana Retirement Fund is August 6, 2007.



STATE OF INDIANA FLEXIBLE BOND FUND
STYLE: UNCONSTRAINED
YEAR ENDED DECEMBER 31, 2018

Manager	PIMCO	Reams
Product	Dynamic Bond	Carillon Reams Unconstrained Bond Fund
Inception Date	6/30/2008	8/1/1998
Organization	Located in Newport Beach, California; Founded in 1971; over \$1.6 trillion in assets under management.	Located in Columbus, Indiana; Founded in 1981; over \$20 billion in assets under management. An autonomous subsidiary of Carillon Investments.
Strategy Description	Absolute return-oriented fixed income strategy that embodies PIMCO's secular thinking, global themes, and integrated investment process without the constraints of a benchmark or significant sector / instrument limitations.	Reams believes volatility is the key driver of performance in the fixed income marketplace, but it is usually higher than expected and often mispriced. As such, they focus on total return, employing macro and bottom-up strategies, seeking relative value opportunities in the market. The team is willing to be patient and wait for opportunities to surface. The Unconstrained strategy provides Reams the full opportunity set in which to invest, and goes back to the team's roots as unconstrained investors at Cummins.
Benchmark	3-month LIBOR	None, though the BC Aggregate can be used as a broad comparison
Return Objective	3-month LIBOR + 3 - 4%	3-month LIBOR + 2%
Risk Objective	4 - 6% standard deviation	Lower volatility than the broad fixed income market
Guidelines	Flexible asset allocation (up to 40% HY, up to 50% EM, up to 35% in Non-USD, no limit on non-US securities) and duration positioning (-3 to 8yrs) seek meaningful returns in most market environments, but allow for defensive positioning and downside protection in challenging markets. Can be short duration/credit.	Duration 0 - 6 yrs; High Yield up to 75%; Non-Dollar up to 10%; Bank Loans up to 15%; will use derivatives but no leverage. The team determines whether the current bond market is cheap or expensive by comparing current real rates to historical rates. They then focus on sectors offering relative value and select securities offering the highest risk-adjusted returns. The team continually measures and controls exposures to security- and portfolio-level risks.
Key Professionals	Marc Seidner, Mohsen Fahmi, Dan Ivascyn	Steven Vincent, Mark Egan, Tom Fink, Todd Thompson, Clark Holland, Jason Hoyer
Assets in Strategy	\$12.0 billion	\$5.2 billion
Vehicle	Mutual Fund PFIUX	Mutual Fund: SUBTX
Fees	87 bps	40 bps



STATE OF INDIANA FLEXIBLE BOND FUND

STYLE: UNCONSTRAINED

YEAR ENDED DECEMBER 31, 2018

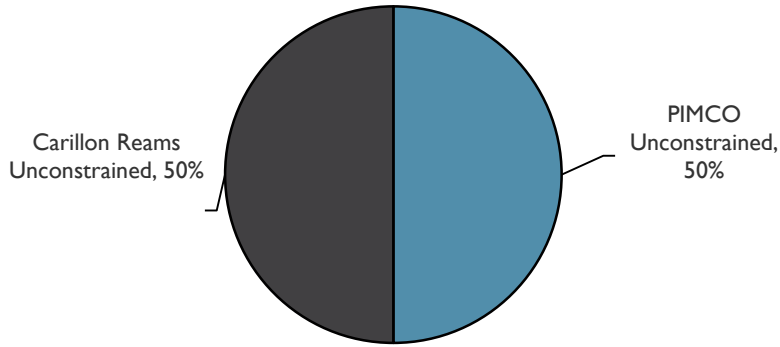

December 31, 2018		% of Plan Assets
Market Value		
Indiana Flexible Bond	\$2,385,123	0.2%

Rolling 12 Quarter Scatter Chart for 5 Years Ended December 31, 2018

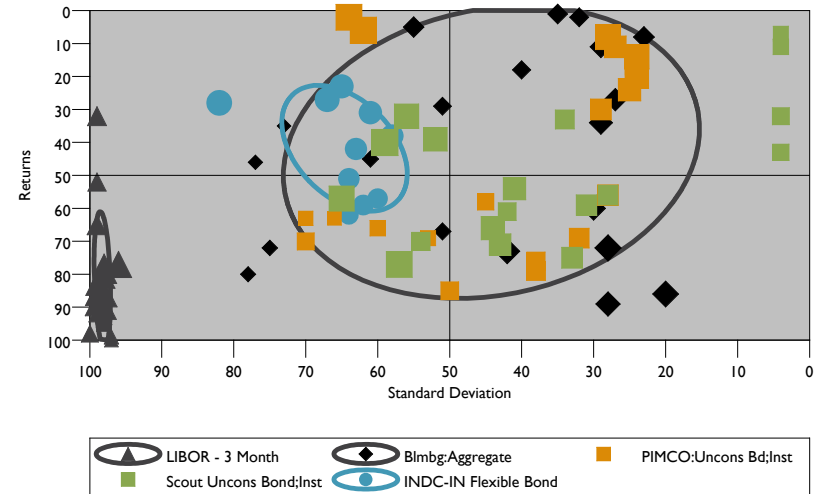

**Returns for Calendar Years
10 Years Ended December 31, 2018**

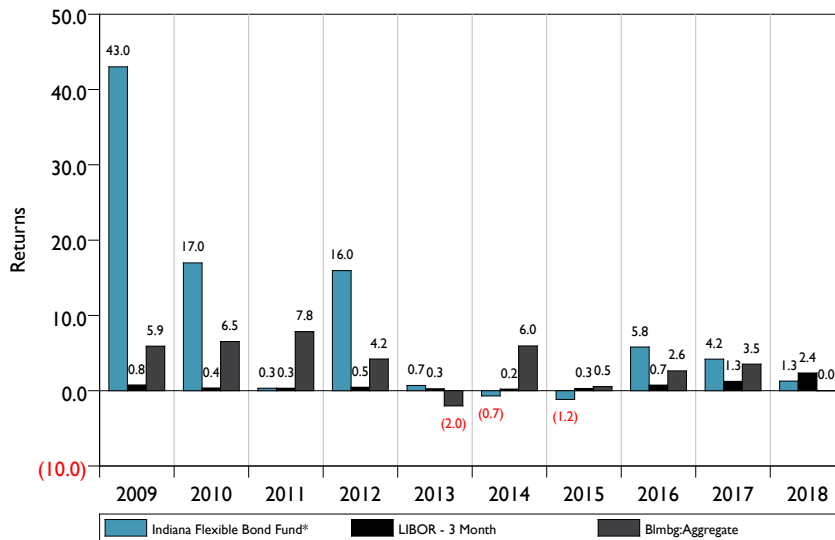

**Rolling 3 Year Returns
for 5 Years Ended December 31, 2018**

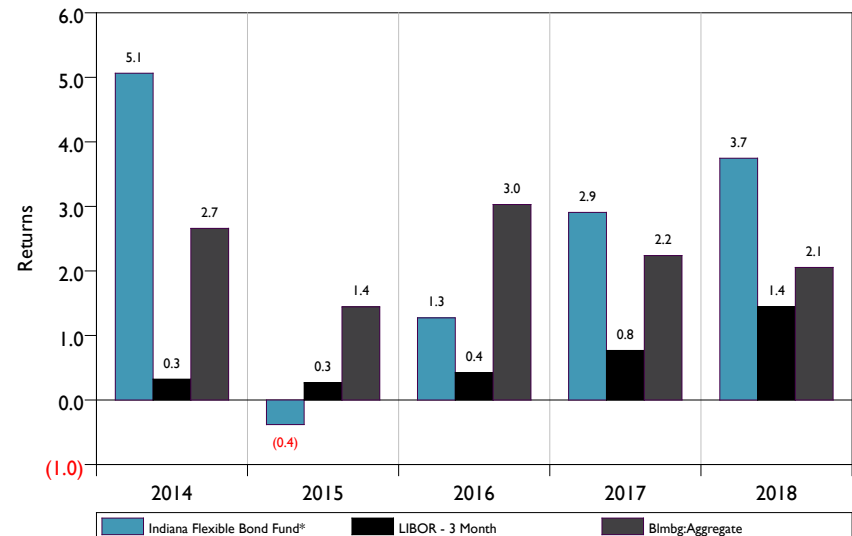

*The inception date of the Indiana Flexible Bond Fund is June 5, 2013.



**STATE OF INDIANA INFLATION-LINKED BOND
STYLE: TIPS
YEAR ENDED DECEMBER 31, 2018**

Organization		BlackRock
Product Name	Inflation Protected Bond	
Product Inception Date	June 28, 2004	
Ownership Structure	BlackRock is independent in ownership and governance, with no single majority stockholder and a majority of independent directors. BlackRock is a public company (NYSE:BLK).	
Firm Information	Headquartered in New York, the firm maintains offices in 30 countries around the world. BlackRock was founded in 1988 with over \$5.9 trillion in assets under management.	
Investment Philosophy	BlackRock blends top-down and bottom-up investment ideas through the utilization of separate investment teams that are responsible for research, analysis, security selection and execution. BlackRock applies the same controlled-duration, relative value sector rotation and security selection strategy to the management of all fixed income, including inflation-linked bonds. BlackRock puts emphasis on risk control.	
Security Selection	The investment process centers around two weekly meetings in which lead portfolio managers and research analysts meet to share ideas. The TIPS team utilizes rigorous quantitative analysis and mathematical modeling to understand the valuation of inflation-linked securities and will at times invest limited portions of the portfolio in sectors such as MBS and corporates.	
Benchmark Awareness	May invest up to 20% in non-investment grade bonds (high yield or junk bonds) or securities of emerging market issuers. May also invest up to 20% in non-dollar denominated securities of non-U.S. issuers, and may invest without limit in U.S. dollar denominated securities of non-U.S. issuers.	
Key Professionals	Christopher Allen, David Rogal	
Assets In Product	\$2.5 billion	
Fees	34 bps	
Vehicle	Mutual Fund (BPLBX)	

December 31, 2018		
	Market Value	% of Plan Assets
Indiana Inflation Linked Bond	\$23,761,898	2.0%



STATE OF INDIANA INFLATION-LINKED BOND STYLE: TIPS YEAR ENDED DECEMBER 31, 2018

Rolling 12 Quarter Scatter Chart for 5 Years Ended December 31, 2018

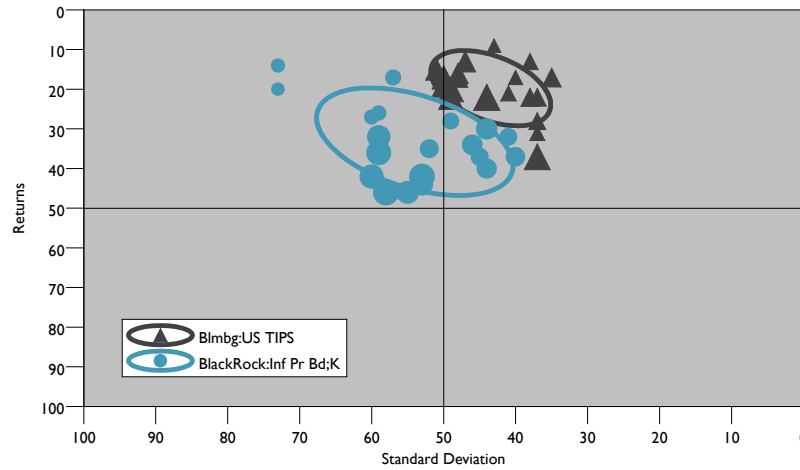

Returns for Calendar Years 10 Years Ended December 31, 2018 Group: Callan Treas Infl Prot Securities MFs

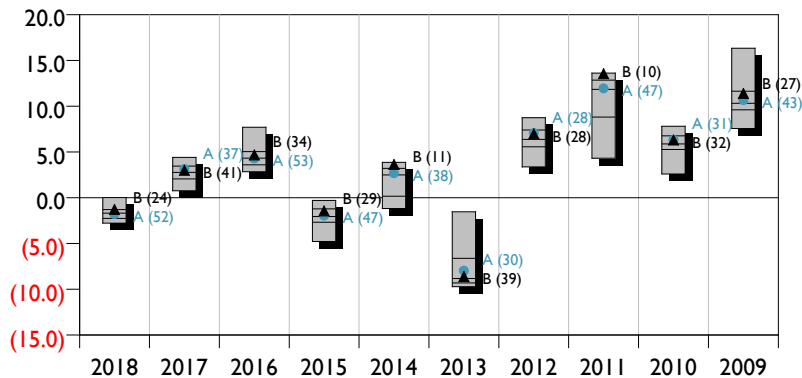

	2018	2017	2016	2015	2014	2013	2012	2011	2010	2009
10th Percentile	0.02	4.42	7.70	(0.29)	3.88	(1.52)	8.74	13.63	7.81	16.35
25th Percentile	(1.29)	3.46	5.04	(1.22)	3.20	(6.62)	7.40	12.86	6.76	11.63
Median	(1.68)	2.77	4.32	(2.06)	2.50	(8.83)	6.37	11.84	5.87	10.31
75th Percentile	(2.26)	2.05	3.60	(2.68)	0.17	(9.30)	5.56	8.81	5.27	9.61
90th Percentile	(2.78)	0.77	2.85	(4.77)	(1.18)	(9.72)	3.37	4.32	2.61	7.57

Returns for 12 Quarter Rolling Periods 5 Years Ended December 31, 2018 Group: Callan Treas Infl Prot Securities MFs

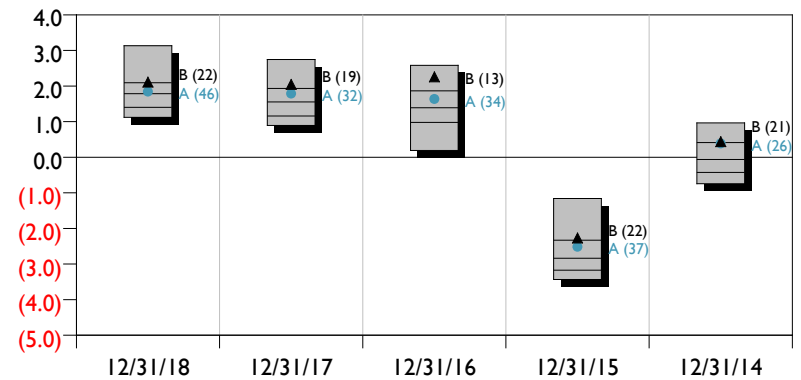

	12/31/18	12/31/17	12/31/16	12/31/15	12/31/14
10th Percentile	3.13	2.75	2.58	(1.16)	0.97
25th Percentile	2.09	1.93	1.87	(2.33)	0.41
Median	1.79	1.55	1.39	(2.84)	(0.06)
75th Percentile	1.40	1.16	0.98	(3.17)	(0.43)
90th Percentile	1.12	0.90	0.19	(3.43)	(0.74)



BlackRock:Inf Pr Bd;K	A	(1.79)	3.14	4.29	(1.95)	2.68	(7.98)	7.08	11.95	6.33	10.66
Blimg:US TIPS	B	(1.26)	3.01	4.68	(1.44)	3.64	(8.61)	6.98	13.56	6.31	11.41

BlackRock:Inf Pr Bd;K	A	1.84	1.79	1.64	(2.51)	0.39
Blimg:US TIPS	B	2.11	2.05	2.26	(2.27)	0.44

**PIMCO TOTAL RETURN
STYLE: CORE BOND
YEAR ENDED DECEMBER 31, 2018**

Organization		PIMCO
Product Name	Total Return Fund	
Product Inception Date	May 11, 1987	
Ownership Structure	Wholly-owned subsidiary of Allianz AG, a Germany-based insurance company.	
Firm Information	Located in Newport Beach, California; Founded in 1971; over \$1.6 trillion in assets under management.	
Investment Philosophy	PIMCO seeks to add value through the use of top-down strategies, such as exposure to interest rates or duration, yield curve positioning and sector rotation. The firm looks to incorporate bottom-up security selection into their process.	
Security Selection	PIMCO considers the full spectrum of global fixed income sectors when evaluating individual securities for inclusion in its Total Return accounts. Security analysis is conducted primarily by PIMCO's specialists using proprietary models and analytics internally developed and maintained by the firm's financial engineers. The specialists are charged with determining relative value within their sectors.	
Credit Sector Issue Constraints	Max 10% in securities rated B or lower.	
Duration	3.47	
Benchmark Awareness	Will deviate from benchmark significantly in terms of duration, yield curve, and sector allocations.	
Key Professionals	Scott A. Mather, Mark R. Kisel, Mihir P. Worah	
Assets In Product	\$180 billion	
Fees	55 bps	
Vehicle	Mutual Fund (PTTRX)	

	December 31, 2018 Market Value	% of Plan Assets
PIMCO Total Return	\$60,075,589	5.0%

**Rolling 12 Quarter Scatter Chart for 5 Years
Ended December 31, 2018**

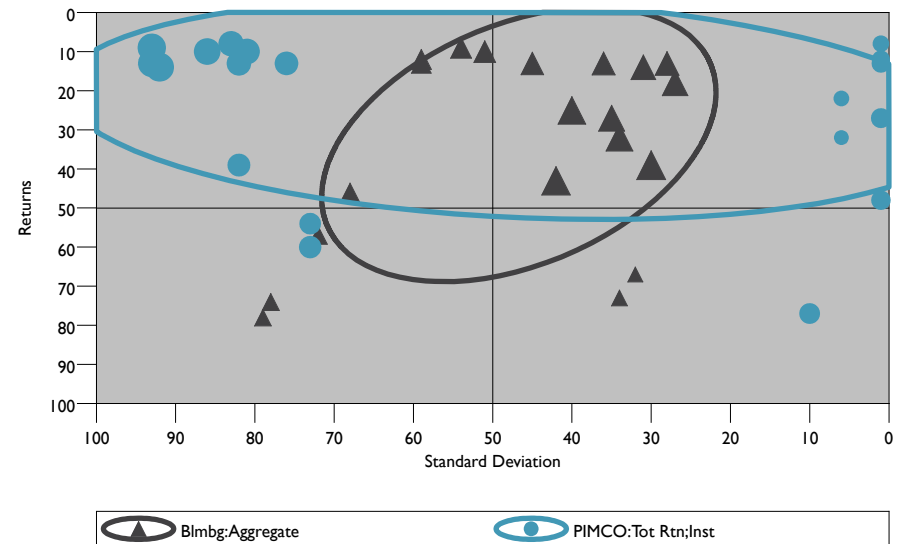

PIMCO TOTAL RETURN STYLE: CORE BOND YEAR ENDED DECEMBER 31, 2018

Returns for Calendar Years
10 Years Ended December 31, 2018
Group: Callan Core Bond Mutual Funds

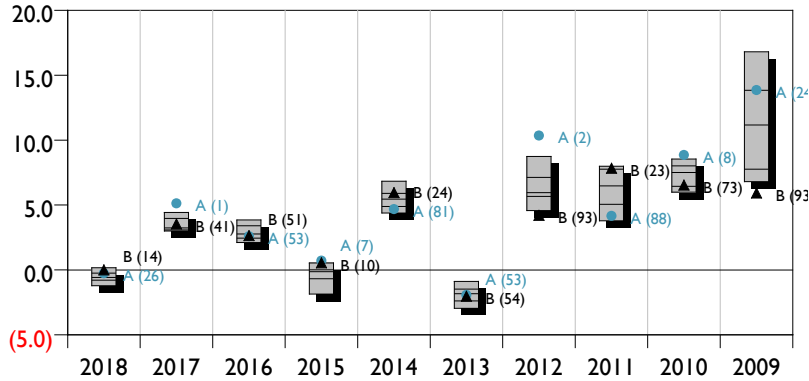

10th Percentile	0.18	4.43	3.85	0.54	6.84	(0.88)	8.75	8.00	8.55	16.81
25th Percentile	(0.24)	3.96	3.41	0.01	5.89	(1.48)	7.13	7.76	8.01	13.84
Median	(0.58)	3.23	2.77	(0.14)	5.45	(1.84)	5.95	6.48	7.51	11.17
75th Percentile	(0.79)	3.08	2.45	(0.68)	4.89	(2.39)	5.66	5.06	6.45	7.76
90th Percentile	(1.21)	3.00	2.12	(1.86)	4.39	(2.95)	4.58	3.79	5.99	6.80
PIMCO:Tot Rtn;Inst	(0.26)	5.13	2.60	0.72	4.69	(1.92)	10.35	4.16	8.86	13.87
Blmbg:Aggregate	0.01	3.54	2.65	0.55	5.97	(2.02)	4.21	7.84	6.54	5.93

Returns for 12 Quarter Rolling Periods
5 Years Ended December 31, 2018
Group: Callan Core Bond Mutual Funds

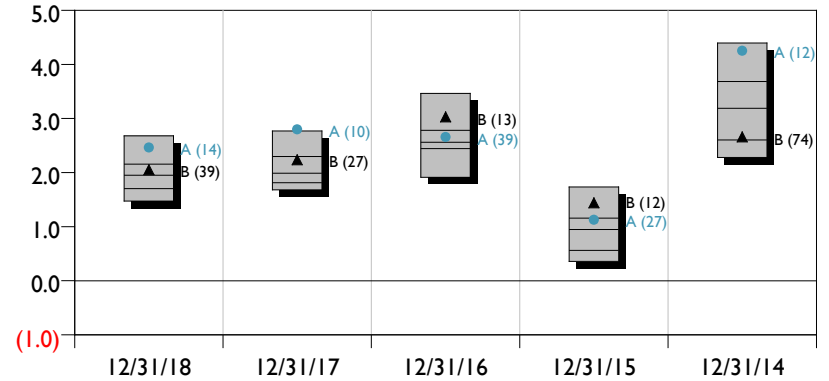

10th Percentile	2.68	2.77	3.47	1.74	4.40
25th Percentile	2.15	2.30	2.78	1.16	3.68
Median	1.95	1.99	2.56	0.95	3.19
75th Percentile	1.70	1.81	2.44	0.56	2.60
90th Percentile	1.47	1.68	1.91	0.36	2.28
PIMCO:Tot Rtn;Inst	2.47	2.80	2.66	1.13	4.25
Blmbg:Aggregate	2.06	2.24	3.03	1.44	2.66

Statistics relative to Blmbg:Aggregate
for 5 Years Ended December 31, 2018
Group: Callan Core Bond Mutual Funds

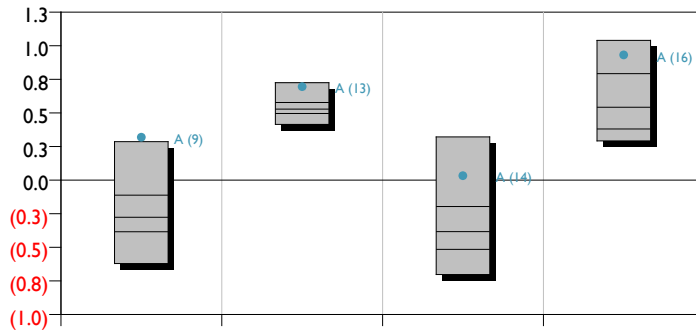

10th Percentile	0.29	0.73	0.32	1.04
25th Percentile	(0.11)	0.58	(0.20)	0.79
Median	(0.28)	0.53	(0.38)	0.54
75th Percentile	(0.38)	0.50	(0.52)	0.38
90th Percentile	(0.62)	0.42	(0.70)	0.29
PIMCO:Tot Rtn;Inst	0.32	0.70	0.03	0.93

Statistics relative to Blmbg:Aggregate
for 5 Years Ended December 31, 2018

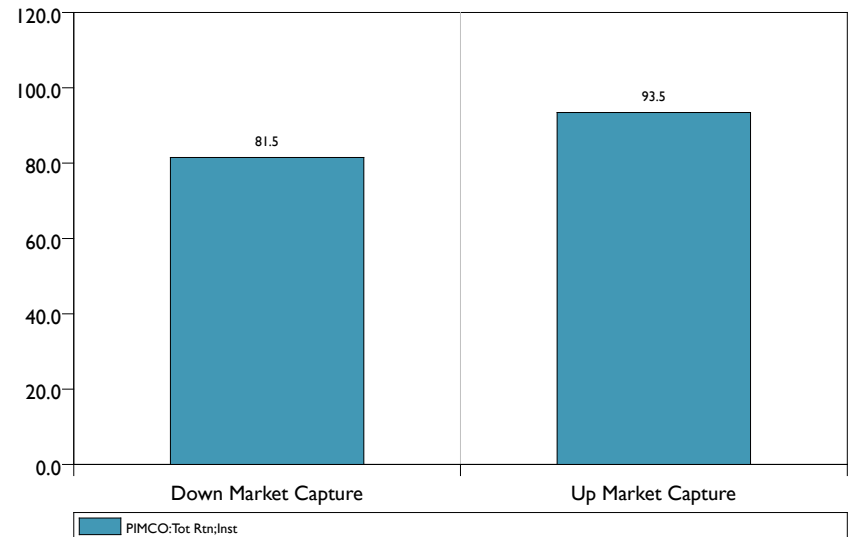

INDIANA STABLE VALUE FUND STYLE: STABLE VALUE YEAR ENDED DECEMBER 31, 2018

Target Allocation

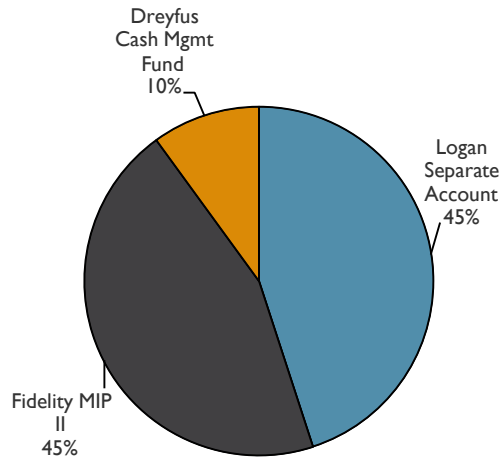

Book/Market Valuation	
% of MV/BV	99.61%
Annualized Yield	2.74%

	December 31, 2018 Market Value	% of Plan Assets
Indiana Stable Value Fund	\$337,443,325	28.0%

Returns for Calendar Years
10 Years Ended December 31, 2018

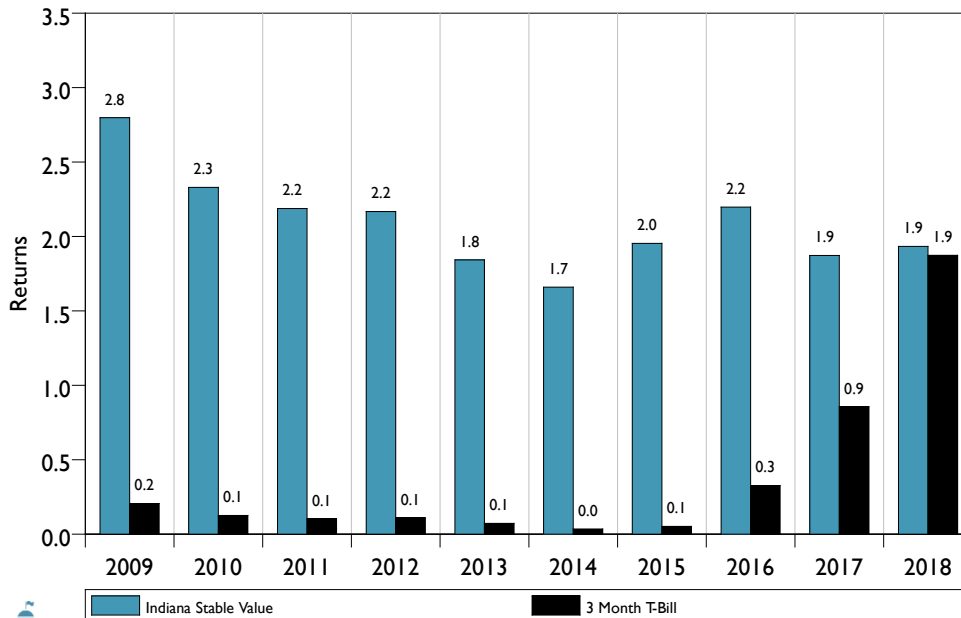

Rolling 3 Year Returns
for 5 Years Ended December 31, 2018

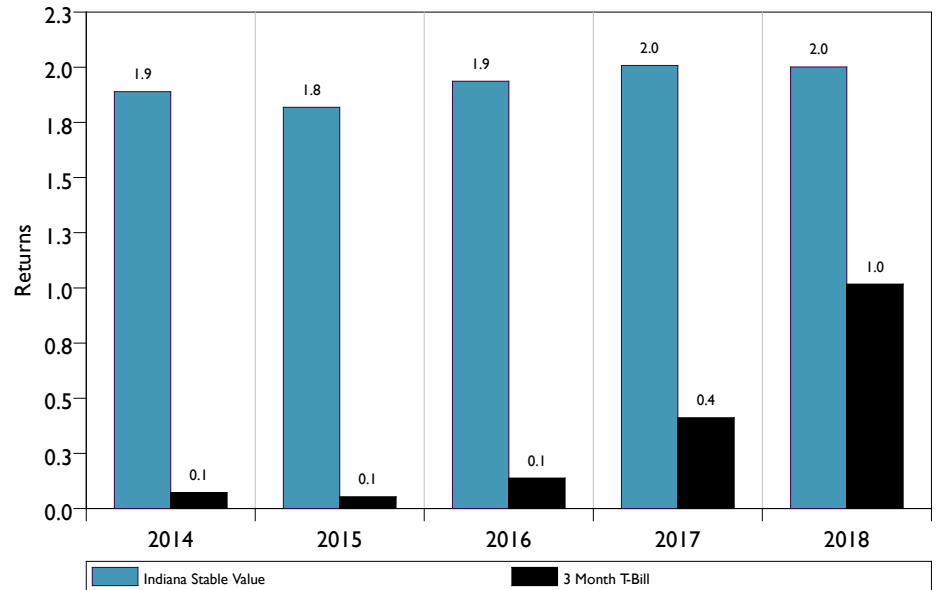

INDIANA STABLE VALUE FUND

STYLE: STABLE VALUE

YEAR ENDED DECEMBER 31, 2018

Returns for Calendar Years
10 Years Ended December 31, 2018
Group: Callan Core Bond Fixed Income

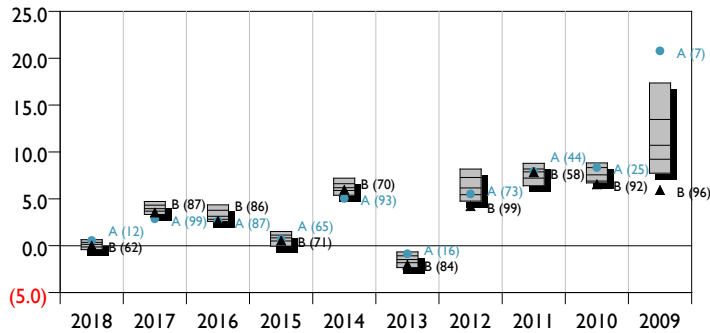

10th Percentile	0.65	4.72	4.36	1.51	7.21	(0.66)	8.18	8.80	8.84	17.36
25th Percentile	0.36	4.32	3.78	1.13	6.61	(1.08)	7.28	8.18	8.33	13.47
Median	0.14	3.96	3.14	0.84	6.19	(1.47)	6.16	7.87	7.56	10.71
75th Percentile	(0.14)	3.68	2.83	0.50	5.90	(1.81)	5.45	7.21	6.89	9.22
90th Percentile	(0.41)	3.34	2.59	(0.04)	5.39	(2.33)	4.76	6.40	6.70	7.74
Logan Circle Core* A	0.55	2.88	2.63	0.67	5.05	(0.86)	5.52	7.92	8.34	20.78
Blmbg:Aggregate B	0.01	3.54	2.65	0.55	5.97	(2.02)	4.21	7.84	6.54	5.93

Returns for 12 Quarter Rolling Periods
5 Years Ended December 31, 2018
Group: Callan Core Bond Fixed Income

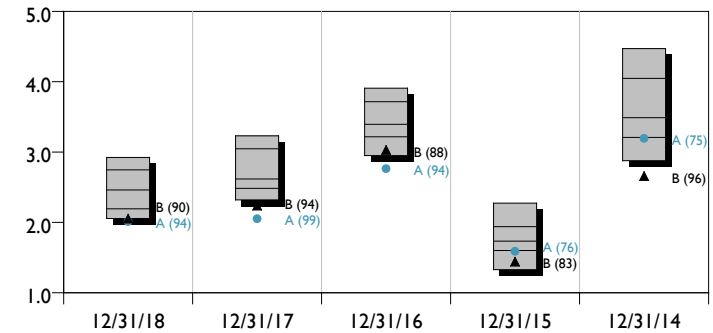

10th Percentile	2.93	3.23	3.91	2.27	4.47
25th Percentile	2.75	3.05	3.72	1.94	4.05
Median	2.46	2.62	3.40	1.73	3.49
75th Percentile	2.19	2.48	3.22	1.60	3.21
90th Percentile	2.06	2.32	2.95	1.33	2.88
Logan Circle Core* A	2.01	2.05	2.76	1.59	3.20
Blmbg:Aggregate B	2.06	2.24	3.03	1.44	2.66

Returns for Calendar Years
10 Years Ended December 31, 2018
Group: Callan Stable Value CT

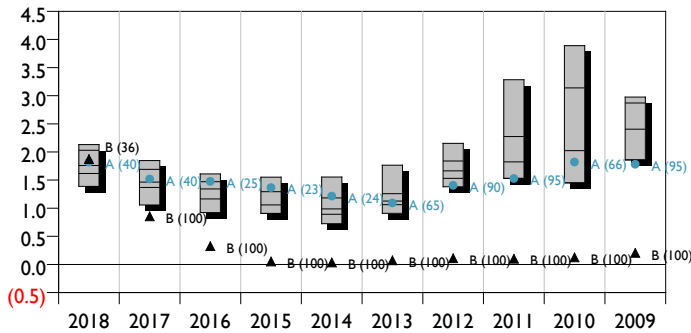

10th Percentile	2.13	1.85	1.61	1.55	1.56	1.77	2.15	3.29	3.89	2.98
25th Percentile	2.03	1.69	1.47	1.29	1.18	1.26	1.84	2.27	3.14	2.87
Median	1.76	1.46	1.34	1.06	0.99	1.13	1.66	1.82	2.02	2.41
75th Percentile	1.62	1.37	1.16	0.91	0.89	1.06	1.53	1.53	1.45	1.86
90th Percentile	1.39	1.06	0.92	0.91	0.72	0.91	1.38	1.53	1.45	1.86
Fidelity MIP II Class III A	1.82	1.52	1.48	1.37	1.22	1.09	1.41	1.53	1.82	1.78
3 Month T-Bill B	1.87	0.86	0.33	0.05	0.03	0.07	0.11	0.10	0.13	0.21

Returns for 12 Quarter Rolling Periods
5 Years Ended December 31, 2018
Group: Callan Stable Value CT

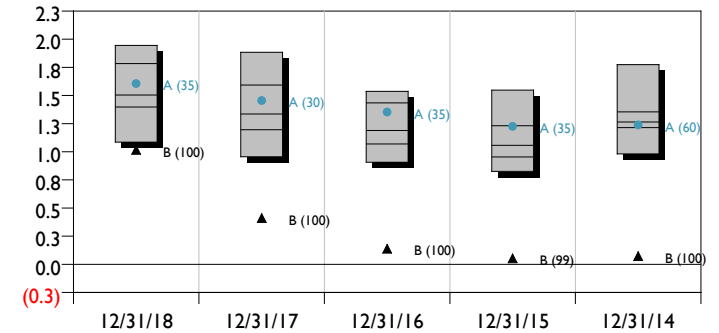

10th Percentile	1.95	1.89	1.54	1.55	1.78
25th Percentile	1.78	1.59	1.43	1.23	1.35
Median	1.50	1.34	1.19	1.06	1.26
75th Percentile	1.40	1.20	1.07	0.95	1.22
90th Percentile	1.09	0.96	0.91	0.83	0.98
Fidelity MIP II Class III A	1.61	1.45	1.35	1.23	1.24
3 Month T-Bill B	1.02	0.41	0.14	0.05	0.07



Logan Circle Core* = INDC actual returns

INDIANA STABLE VALUE FUND STYLE: STABLE VALUE YEAR ENDED DECEMBER 31, 2018

Returns for Calendar Years
10 Years Ended December 31, 2018
Group: Callan Money Market Funds

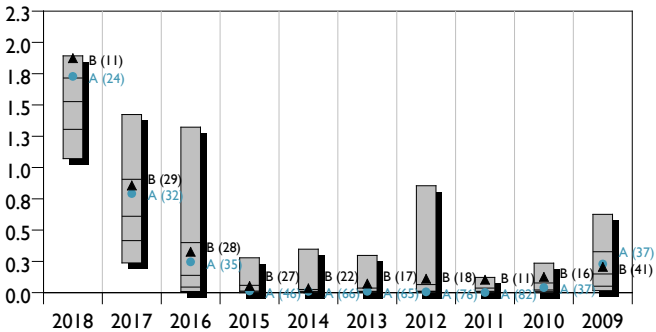

	2018	2017	2016	2015	2014	2013	2012	2011	2010	2009
10th Percentile	1.89	1.42	1.32	0.28	0.35	0.30	0.85	0.12	0.24	0.63
25th Percentile	1.72	0.91	0.40	0.06	0.03	0.04	0.06	0.04	0.08	0.33
Median	1.53	0.61	0.14	0.01	0.01	0.01	0.01	0.01	0.02	0.15
75th Percentile	1.31	0.42	0.04	0.01	0.01	0.01	0.01	0.01	0.01	0.05
90th Percentile	1.07	0.24	0.01	0.00	0.00	0.00	0.00	0.00	0.00	0.02
Dreyfus Gvt Csh Mgt;Inst	● A	1.73	0.79	0.25	0.01	0.01	0.01	0.00	0.04	0.23
3 Month T-Bill	▲ B	1.87	0.86	0.33	0.05	0.03	0.07	0.11	0.13	0.21

Returns for 12 Quarter Rolling Periods
5 Years Ended December 31, 2018
Group: Callan Money Market Funds

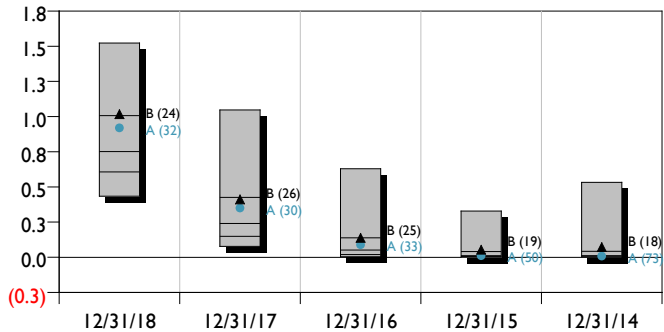

	12/31/18	12/31/17	12/31/16	12/31/15	12/31/14
10th Percentile	1.52	1.05	0.63	0.33	0.53
25th Percentile	1.01	0.43	0.14	0.04	0.04
Median	0.75	0.24	0.05	0.01	0.01
75th Percentile	0.61	0.15	0.02	0.01	0.01
90th Percentile	0.43	0.08	0.00	0.00	0.00
Dreyfus Gvt Csh Mgt;Inst	● A	0.92	0.35	0.09	0.01
3 Month T-Bill	▲ B	1.02	0.41	0.14	0.05



Plan Fees

Investment Management Fees

Manager	Style	Fee Schedule	Median Peer Group Fees	Manager	Style	Fee Schedule	Median Peer Group Fees
VIIIX Vanguard Institutional Index	Passive Core Equity	2 basis points		FKIDX Fidelity Diversified International	Core International	60 basis points	110 basis points
VFTNX Vanguard FTSE Social Index	Core Equity	12 basis points		REGRX American Funds EuroPacific Growth	Non-US Equity	49 basis points	110 basis points
VITSX Vanguard Total Stock Market Index*	Total Stock	3.5 basis points		EPSRX Mainstay Epoch Shareholder Yield*	Unconstrained Equity	74 basis points	
Boston Company Dynamic Large Cap Value	Large Cap Value	42 basis points	95 basis points	PVSYX Putnam Capital Spectrum*	Unconstrained Equity	41 basis points	
T. Rowe Price Blue Chip Growth	Large Cap Growth	45 basis points	100 basis points	Indiana Retirement Funds	Lifestyle	29-44 basis points	69-86 basis points
MVCKX MFS Mid Cap Value	Mid Cap Value	71 basis points	110 basis points	Indiana Flexible Bond Fund	Unconstrained F/I	64 basis points	95 basis points
VHCAX Vanguard Capital Opportunity	Mid Cap Growth	37 basis points	112 basis points	BPLBX BlackRock Inflation Protected Bond	TIPS	34 basis points	68 basis points
VIEIX Vanguard Extended Market Index	Small Cap Broad	6 basis points		PTTRX PIMCO Total Return	Core Bond	55 basis points	70 basis points
FLPSX Fidelity Low-Priced Stock	Specialty	62 basis points (25 bps rev sharing)		Indiana Stable Value Fund	Stable Value	42 basis points	
VTSNX Vanguard Total International Stock Index*	Passive Core International	9 basis points		Wellington Real Total Return*	Alternatives	48 basis points	

*An underlying component of the custom Indiana Target Date Funds. Not available on a stand-alone basis.

- All of the investment options have fees that are below peers.

Total Fees

Manager	Style	12/31/18 Market Value	Net Inv Mgmt Fees (%)	Est. Inv Mgmt Fees (\$)
Vanguard Institutional Index	Passive Core Equity	\$110,258,982	0.02%	\$22,052
Vanguard FTSE Social Index	Core Equity	\$16,576,362	0.12%	\$19,892
EB Dynamic Value	Large Cap Value	\$67,908,280	0.42%	\$285,215
T. Rowe Price Blue Chip Growth	Large Cap Growth	\$86,005,045	0.45%	\$387,023
MFS Mid Cap Value	Mid Cap Value	\$34,627,054	0.71%	\$245,852
Vanguard Capital Opportunity	Mid Cap Growth	\$107,980,232	0.37%	\$399,527
Vanguard Extended Market Index	Small Cap Broad	\$43,804,934	0.06%	\$26,283
Fidelity Low-Priced Stock	Specialty	\$19,582,953	0.37%	\$72,457
Fidelity Diversified International	Core International	\$43,696,662	0.60%	\$262,180
American Funds EuroPacific Growth	Core International	\$43,350,171	0.49%	\$212,416
Indiana 2060 Fund	Lifestyle	\$6,051,615	0.29%	\$17,550
Indiana 2055 Fund	Lifestyle	\$5,023,954	0.29%	\$14,569
Indiana 2050 Fund	Lifestyle	\$17,514,145	0.29%	\$50,791
Indiana 2045 Fund	Lifestyle	\$28,562,156	0.30%	\$85,686
Indiana 2040 Fund	Lifestyle	\$10,964,173	0.32%	\$35,085
Indiana 2035 Fund	Lifestyle	\$32,132,421	0.34%	\$109,250
Indiana 2030 Fund	Lifestyle	\$13,142,318	0.37%	\$48,627
Indiana 2025 Fund	Lifestyle	\$43,064,116	0.39%	\$167,950
Indiana 2020 Fund	Lifestyle	\$13,633,091	0.42%	\$57,259
Indiana Retirement Fund	Lifestyle	\$36,826,485	0.44%	\$162,037
Indiana Flexible Bond Fund	Unconstrained F/I	\$2,385,123	0.64%	\$15,265
Indiana Inflation Protected Bond	TIPS	\$23,761,898	0.34%	\$80,790
PIMCO Total Return	Core Bond	\$60,075,589	0.55%	\$330,416
Indiana Stable Value Fund	Stable Value	\$337,443,325	0.42%	\$1,417,262
		\$1,204,371,084	0.38%	\$4,525,433

- The estimated investment management fees for the past year totaled \$4,525,433.*
- The administrative fees paid in calendar year 2018 were \$2,750,927.

Reality Investing Fee Schedule

Participant Account Balances	Quarterly Fee	Annual Fee
<= \$100,000	0.1125%	0.45%
Next \$150,000	0.0875%	0.35%
Next \$150,000	0.0625%	0.25%
>=\$400,000	0.0375%	0.15%

- Reality Investing fees paid in calendar year 2018 were \$892,006.

*Based on December 31, 2018 market values.

Glossary

Floating Bar Return Chart

The Floating Bar chart is used to compare a manager's return against a style group and benchmark's return. A style group is a collection of funds/managers that uses a similar investment strategy for the investment management of their portfolio. It is intended to be a comparison of active managers.

The floating bar represents 80% of the managers included in a particular style group of Callan's universe. The top of the floating bar indicates the 10th percentile of the group and the bottom represents the 90th percentile. The middle dashed line is the median, which has a percent rank of 50. The dashed line just above this is the 25th percentile and the one below is the 75th percentile. The higher up on the floating bar chart the better. The number in parentheses next to each floating bar is the percentile (1 = best performer, 100 = worst performer) the manager and the index ranked for that period. For example, if a fund ranked at the 37th percentile, it means that the fund outperformed 63% of the managers in that particular style group and underperformed 37% of the managers in that group.

Risk vs. Return Scatter Chart

The Risk vs. Return scatter chart is used to show a graphical representation of a manager's risk/return profile within a style group. Returns are on the vertical axis and standard deviation (risk) is on the horizontal axis. The scatter chart is broken down into four quadrants: northeast, northwest, southeast, and southwest. The northwest quadrant (more return/less risk) is the ideal place for a portfolio to reside. The southeast quadrant (less return/more risk) is the worst quadrant. The crosshairs in the chart represent the median (50th Percentile) return and median standard deviation of the particular style group.

Alpha

Alpha measures a portfolio's return in excess of the market return adjusted for risk. It is a measure of the manager's contribution to performance with reference to security selection. A positive alpha indicates that a portfolio was positively rewarded for the residual risk which was taken for that level of market exposure.

Basis Point

1% change = 100 basis points, and 0.01% = 1 basis point.

Coupon Rate

The average coupon is the market value weighted average coupon of all securities in the portfolio. The total coupon payments per year are divided by the total portfolio par value.

Dividend Yield

Dividend Yield is the total amount of dividends paid out for a stock over the preceding twelve months divided by the closing price of a share of the common stock.

Down Market Capture

Down Market Capture represents the ratio of return generated by a manager versus an index when that index is performing negatively.

Downside Risk

Downside Risk stems from the desire to differentiate between "good risk" (upside volatility) and "bad risk" (downside volatility). Whereas standard deviation punishes both upside and downside volatility, downside risk measures only the standard deviation of returns below the target. Returns above the target are assigned a deviation of zero. Both frequency and magnitude of underperformance affect the amount of downside risk.

Effective Maturity

This is a measure of the market-value-weighted-average of the years to expected maturity across all of the securities in the portfolio. Expected years to maturity takes into account any put or call options embedded in the security, any expected sinking-fund paydowns or any expected mortgage principal prepayments.

Glossary

Effective Yield

The effective yield is the actual total annualized return that would be realized if all securities in the portfolio were held to their expected maturities. Effective yield is calculated as the internal rate of return, using the current market value and all expected future interest and principal cash flows. This measure incorporates sinking fund paydowns, expected mortgage principal prepayments, and the exercise of any “in-the-money” embedded put or call options.

Excess Return Ratio

Excess Return Ratio is a measure of risk adjusted relative return. This ratio captures the amount of active management performance (value added relative to an index) per unit of active management risk (tracking error against the index). It is calculated by dividing the manager’s annualized cumulative excess return relative to the index by the standard deviation of the individual quarterly excess returns. The Excess Return Ratio can be interpreted as the manager’s active risk/reward tradeoff for diverging from the index when the index is mandated to be the “riskless” market position.

Forecasted Growth in Earnings

This growth rate is a measure of a company’s expected long-term success in generating future year-over-year earnings growth. This growth rate is a market value weighted average of the consensus (mean) analysts’ long-term earnings growth rate forecast for each company in the portfolio. The definition of long-term varies by analyst but is limited to a 3-8 year range. This value is expressed as the expected average annual growth of earnings in percent.

Information Ratio

The information ratio measures the manager’s market risk-adjusted excess return per unit of residual risk relative to a benchmark. It is computed by dividing alpha by the residual risk over a given time period. Assuming all other factors being equal, managers with lower residual risk achieve higher values in the information ratio. Managers with higher information ratios will add value relative to the benchmark more reliably and consistently.

Managers with higher Information Ratios have demonstrated higher risk-adjusted excess returns per unit of residual risk over the time period measured. When plotted on a floating bar chart versus managers of a similar style, the higher the manager ranks (1 = best, 100 = worst) the better.

Option Adjusted Duration

The modified duration of a security, calculated using a model that accounts for embedded options. The OA duration indicates how cash flows change when interest rates change.

Price/Book Value

The Price to Book Value is a measure of value for a company. It is equal to the market value of all the shares of common stock divided by the book value of the company. The book value is the sum of capital surplus, common stock, and retained earnings.

Price/Earnings Ratio

The Price to Earnings Ratio (P/E) is a measure of value for a company. It is equal to the price of a share of common stock divided by the earnings per share for a twelve-month period.

Quality Rating

Quality Rating is typically assigned by a third-party rating agency, such as Standard & Poor’s, Moody’s or Fitch. Quality ratings measure the relative investment quality of bonds by using symbols which range from the highest investment quality (least investment risk) to the lowest investment quality (greatest investment risk).

Glossary

Relative Standard Deviation

Relative Standard Deviation is a simple measure of a manager's risk (volatility) relative to a benchmark. It is calculated by dividing the manager's standard deviation of returns by the benchmark's standard deviation of returns. A relative standard deviation of 1.20, for example, means the manager has exhibited 20% more risk than the benchmark over that time period. A ratio of .80 would imply 20% less risk. This ratio is especially useful when analyzing the risk of investment grade fixed-income products where actual historical durations are not available. By using this relative risk measure over rolling time periods one can illustrate the "implied" historical duration patterns of the portfolio versus the benchmark.

Managers with lower Relative Standard Deviations have demonstrated lower volatility relative to their benchmark over the time period measured. When plotted on a floating bar chart versus managers of a similar style, the lower the manager ranks (1 = worst, 100 = best) the better.

Residual Portfolio Risk

Residual Portfolio Risk is the unsystematic risk of a fund, the portion of the total risk unique to the fund (manager) itself and not related to the overall market. This reflects the "bets" which the manager places in that particular asset market. These bets may reflect emphasis in particular sectors, maturities (for bonds), or other issue specific factors which the manager considers a good investment opportunity. Diversification of the portfolio will reduce or eliminate the residual risk of that portfolio.

Sharpe Ratio

Sharpe Ratio is a commonly used measure of risk-adjusted return. It is calculated by subtracting the "risk-free" return (usually 3 Month Treasury Bill) from the portfolio return and dividing the resulting "excess return" by the portfolio's risk level (standard deviation). The result is a measure of return gained per unit of risk taken.

Managers with higher Sharpe Ratios have demonstrated excess return per unit of risk over the time period measured. When plotted on a floating bar chart versus managers of a similar style, the higher the manager ranks (1 = best, 100 = worst) the better.

Standard Deviation

Standard Deviation is a statistical measure of portfolio risk. It reflects the average deviation of the observations from their sample mean. Standard deviation is used as an estimate of risk since it measures how wide the range of returns typically is. The wider the typical range of returns, the higher the standard deviation of returns, and the higher the portfolio risk. If returns are normally distributed (i.e. has a bell shaped curve distribution) then approximately 2/3 of the returns would occur within plus or minus one standard deviation from the sample mean.

Up Market Capture

Up Market Capture represents the ratio of return generated by a manager versus an index when that index is performing positively.

Weighted Average Market Capitalization

Weighted Average Market Capitalization is the average market value of all outstanding common stock of companies included in a portfolio, weighted in proportion to their percentage of net assets in the fund.

Styles

Large Cap Core Equity Index: Large Cap Core Equity Index Style managers hold portfolios with characteristics similar to those of the broader market as represented by the Standard & Poor's 500 Index or the KL Domini Social 400 Index.

Glossary

Large Cap Core Equity: Large Cap Core managers' portfolio holdings and characteristics are similar to that of the broader market as represented by the Standard & Poor's 500 Index, with the objective of adding value over and above the index, typically from sector or issue selection. The core portfolio exhibits similar risk characteristics to the broad market as measured by low residual risk with Beta and R-Squared values close to 1.00.

Large Cap Value Equity: Large Cap Value Equity managers invest in predominately large capitalization companies believed to be undervalued or possessing lower than average price to book and price to earnings ratios. The companies are expected to have a near-term earnings rebound and realize their potential for capital appreciation.

Large Cap Growth Equity: Large Cap Growth Equity managers invest in predominately large capitalization companies that are expected to have above average prospects for long-term growth in earnings and profitability. Future growth prospects take precedence over valuation levels in the stock selection process.

Mid Cap Value: Mid Cap Value Equity managers invest primarily in mid-capitalization companies believed to be currently undervalued in the general market. Valuation issues take precedence over near term earnings prospects in the stock selection process. Market capitalizations are generally between core (large) equity companies and small capitalization companies.

Mid Cap Growth: Mid Cap Growth Equity managers invest primarily in mid-capitalization companies that are expected to have above average prospects for long-term growth in earnings and profitability. Future growth prospects take precedence over valuation levels in the stock selection process. Market capitalizations are generally between core (large) equity companies and small capitalization companies.

Small Cap Broad: Small Cap Broad Equity managers invest primarily in companies with relatively small capitalization. The companies typically have zero dividends or dividend yields below the broader market. The securities exhibit greater volatility than the broader market as measured by the risk statistics beta and standard deviation. Managers will generally invest in both value and growth stocks.

International Core Equity: International Core Equity managers invest in a well-diversified portfolio of mostly large issues in developed countries with liquid markets, resulting in characteristics similar to that of an index such as the Morgan Stanley Capital International (MSCI) EAFE Index.

Lifestyle: This style consists of funds whose primary objective is to split its investment assets among stocks, bonds, and other investment vehicles in an attempt to provide consistent return for the investor while diversifying an investor's assets among different types of investment products.

Treasury Inflation-Protected Securities (TIPS): TIPS are securities issued by the U.S. Treasury that offer inflation protection to investors. They have a fixed coupon rate but their principal value is adjusted at periodic intervals to reflect changes in the Consumer Price Index (CPI).

Core Bond: Core Bond managers construct portfolios to approximate the investment results of the Barclays Capital Government/Credit Bond Index or the Barclays Capital Aggregate Bond Index with a modest amount of variability in duration around the index. The objective is to achieve value added from sector and/or issue selection.

Unconstrained Fixed Income: Unconstrained fixed income managers do not construct portfolios based on a given benchmark, thus have the ultimate flexibility to adjust the exposures of the funds (duration/yield curve, quality, country and currency positioning, sector allocations) to reflect their views on the market's opportunities and risks. Additionally, these portfolios will often have the ability to be both long and short, but typically maintain net long positions.

Stable Value: Seeks to provide a competitive level of income over time while preserving the principal value. Returns are expected to be above that of a money market fund.

Glossary

Indices

Standard & Poor's 500 Index: The S&P 500 Index is a capitalization weighted index comprised of 500 stocks chosen for market size, liquidity, and industry group representation. The S&P 500 Index is constructed to represent a broad range of industry segments in the U.S. economy. The S&P 500 focuses on the large-cap segment of the market with over 80% coverage of US equities. Criteria for inclusion include financial stability (minimize turnover in the index), screening of common shares to eliminate closely held companies, and trading activity indicative of ample liquidity and efficient share pricing. Companies in merger, acquisition, leveraged-buy-outs, bankruptcy, restructuring, or lack of representation in their representative industry groups are eliminated from the index.

FTSE 4Good U.S. Select Index: The FTSE4Good U.S. Select Index is a socially responsible investment (SRI) index of US stocks that excludes companies with certain business activities such as weapons, tobacco, gambling, alcohol, nuclear power, and adult entertainment. Additionally, in order to be included companies must meet a series of stringent environmental and social criteria in areas including environmental management, labor rights, human rights, health and safety, and diversity.

Russell 1000 Value Index: Russell 1000 Value index measures the performance of those Russell 1000 companies with lower price-to-book ratios and lower forecasted growth values.

Russell 1000 Growth Index: Russell 1000 Growth index measures the performance of those Russell 1000 companies with higher price-to-book ratios and higher forecasted growth values.

Russell Mid Cap Value Index: Russell Mid Cap Value index measures the performance of the mid-capitalization sector of the US equity market. It invests in those Russell Midcap Index companies with lower price-to-book ratios and lower forecasted growth.

Russell Mid Cap Growth Index: Russell Mid Cap Growth index measures the performance of those Russell Midcap companies with higher price-to-book ratios and higher forecasted growth values. The stocks are also members of the Russell 1000 Growth index.

S&P Completion Index: S&P Completion Index comprises all members of the S&P TMI Index except for the current constituents of the S&P 500. The index covers approximately 3000 constituents, offering investors broad exposure to mid, small, and micro cap companies.

Russell 2000 Index: Russell 2000 index measures the performance of the 2,000 smallest companies in the Russell 3000 Index, which represents approximately 8% of the total market capitalization of the Russell 3000 Index.

Morgan Stanley Capital International (MSCI) EAFE Index: Morgan Stanley Capital International (MSCI) EAFE index is composed of approximately 1000 equity securities representing the stock exchanges of Europe, Australia, New Zealand, and the Far East. The index is capitalization-weighted and is expressed in terms of U.S. dollars.

Morgan Stanley Capital International (MSCI) ACWI ex-US Index: Morgan Stanley Capital International (MSCI) ACWI Index is a free float-adjusted market capitalization weighted index that is designed to measure the equity market performance of developed and emerging markets, excluding US stocks, and is expressed in terms of U.S. dollars.

Barclays Capital U.S. TIPS Index: The Barclays Capital U.S. TIPS Index represents securities that protect against adverse inflation and provide a minimum level of real return. To be included in the index, bonds must have cash flows linked to an inflation index, be sovereign issues denominated in U.S. currency, and have more than one year to maturity.

Barclays Capital Aggregate Bond Index: The Barclays Capital Aggregate Bond index includes fixed rate debt issues rated investment grade or higher by Moody's Investors Service, Standard and Poor's, or Fitch Investor's Service, in that order. All issues must have at least 1 year left to maturity and have an outstanding par value of at least \$100 million.

90-Day U.S. Treasury Bills: 90-Day U.S. Treasury Bills provide a measure of riskless return. The rate of return is the average interest rate available on the beginning of each month for a Treasury Bill maturing in ninety days.

How to Read a Scatterchart

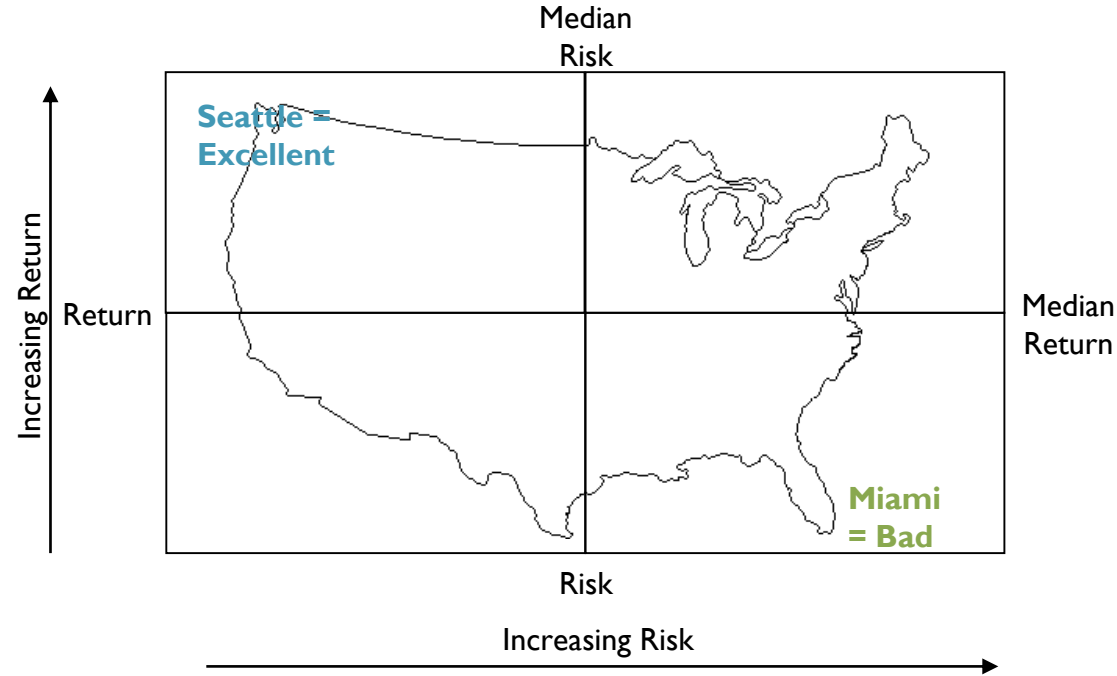

How to Read a Floating Bar Chart

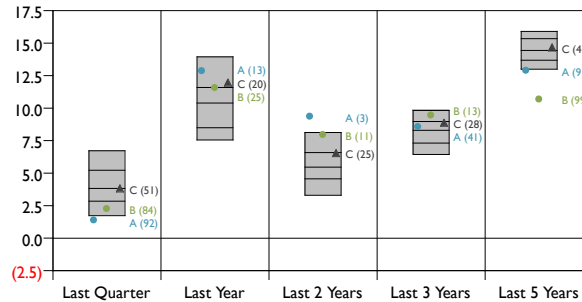

10th Percentile	6.72	13.95	8.13	9.83	15.91
25th Percentile	5.23	11.59	6.58	8.97	15.35
Median	3.83	10.40	5.47	8.30	14.44
75th Percentile	2.85	8.50	4.57	7.32	13.69
90th Percentile	1.73	7.55	3.30	6.44	13.00
Manager A	1.37	12.85	9.35	8.55	12.88
Manager B	2.25	11.55	7.94	9.44	10.67
S&P:500	3.82	11.96	6.54	8.87	14.66

How to Read a Bar Chart

The top line of the bar indicates the top 10th percentile of the universe. The middle solid line is the median, which has a percent rank of 50. The 75th percentile is indicated by the lower dotted line and the 90th percentile is indicated by the bottom line.

